

RI 9433

REPORT OF INVESTIGATIONS/1992

Rock Mechanics Investigations at the Lucky Friday Mine

(In Three Parts)

2. Evaluation of Underhand Backfill Practice for Rock Burst Control

By **J. K. Whyatt, T. J. Williams,
and M. P. Board**

UNITED STATES DEPARTMENT OF THE INTERIOR



BUREAU OF MINES

Library of Congress Cataloging in Publication Data:

Rock mechanics investigations at the Lucky Friday Mine.

p. cm. — (Report of investigations; 9433)

Includes bibliographical references (p. 10).

Contents: 1. Instrumentation of an experimental underhand longwall stope / by T.J. Williams, J.K. Whyatt, and M.E. Poad—2. Evaluation of underhand backfill practice for rock burst control / by J.K. Whyatt, T.J. Williams, and M.P. Board—3. Calibration and validation of a stope-scale, finite-element model / by W.G. Pariseau, J.K. Whyatt, and T.J. McMahon.

1. Rock bursts—Idaho—Lucky Friday Mine. 2. Longwall mining—Idaho—Lucky Friday Mine. 3. Rock mechanics—Idaho—Lucky Friday Mine. I. Williams, Theodore Joseph, 1923- . II. Whyatt, J. K. (Jeff K.). III. Poad, M. E. IV. Series: Report of investigations (United States. Bureau of Mines); 9433.

TN23.U43 [TN317] 622 s—dc20 [622'.28] 90-15069 CIP

CONTENTS

	<i>Page</i>
Abstract	1
Introduction	2
Acknowledgments	3
Backfill behavior	3
Numerical analysis of effects of placement gaps in fill	5
Stope model parametric study	7
Rock burst hazard study	9
Discussion and conclusions	10
References	10

ILLUSTRATIONS

1. Schematic of cut-and-fill mining methods	2
2. Unconfined compression stress-strain curves for 6-pct cement fill using fine and coarse total mill tailings	3
3. Measured stope closure-fill pressure curves responding to excavation of following cut in LFUL	4
4. Backfill placement in typical underhand stope	4
5. Numerical model simulation of unconfined compression test with backfill properties	5
6. Original problem mesh and deforming paste fill pillars during numerical model simulation of stope closure	6
7. Stress-strain response at center of model backfill pillar	6
8. Large-scale finite-difference mesh for vertical cross section of LFUL	7
9. Range of stope half-closures for various rock mass property and fill assumptions	8
10. Horizontal stress at stope face for various models	8
11. Effective fill support pressure	9

TABLES

1. Backfill properties used in FLAC numerical simulations of stope and gap closure	5
2. Rock mass properties used to model cross section of underhand stope	8

UNIT OF MEASURE ABBREVIATIONS USED IN THIS REPORT

deg degree

ft foot

ft² square foot

in inch

lb/ft³ pound of mass per cubic
foot

pct percent

psi pound of force per square
inch

ROCK MECHANICS INVESTIGATIONS AT THE LUCKY FRIDAY MINE

(In Three Parts)

2. Evaluation of Underhand Backfill Practice for Rock Burst Control

By J. K. Whyatt,¹ T. J. Williams,¹ and M. P. Board²

ABSTRACT

The U.S. Bureau of Mines has been conducting a series of rock mechanics investigations at the Lucky Friday Mine in the Coeur d'Alene Mining District of northern Idaho. In the present study, the energy release rate (ERR) index was used to evaluate three underhand stope backfill parameters—cement content, density, and placement gap—to determine their influence on rock bursts. This index provides a relative measure of the likelihood of rock bursting for a given rock mass. It is known that the elastic idealization of the rock mass inherent in this method causes underestimation of stope closure and hence underestimation of the influence of backfill on rock bursting. However, this evaluation still showed that (1) changing from present practice to one in which backfill was omitted altogether would increase the ERR by 42 pct and (2) perfect placement of backfill would reduce the ERR below present practice levels by 28 pct. The easiest step toward perfect placement would be elimination of the placement gap, which accounted for half of the difference in ERR between present practice and ideal placement conditions. There was no indication that increasing initial fill strength through increased cement content would affect the ERR.

¹Mining engineer, Spokane Research Center, U.S. Bureau of Mines, Spokane, WA.

²Project engineer, Itasca Consulting Group, Inc., Minneapolis, MN.

INTRODUCTION

Rock bursts have a long history in the Coeur d'Alene Mining District of northern Idaho (11)³ and are threatening the future of many district mines. The U.S. Bureau of Mines has long been involved in developing alternatives to the traditional overhand cut-and-fill stoping method (fig. 1A) that would reduce rock burst hazards and be amenable to mechanization. One of these methods, the underhand longwall cut-and-fill method (fig. 1B), was chosen for testing at the Lucky Friday Mine, Mullan, ID. The experimental stope, dubbed the Lucky Friday underhand longwall (LFUL) stope, was tested under a cooperative agreement among the Bureau, Hecla Mining Co., Coeur d'Alene, ID, and the University of Idaho, Moscow, ID.

The principle of a single advancing face, which is central to the underhand longwall method, is not new. In fact, the South African High-Level Committee on Rock Bursts and Rock Falls recommended the use of longwalls

as a means of reducing rock burst hazards associated with mining remnants (or sill pillars) as early as 1924 (9). Longwall mining is now standard practice in the deep gold mines of South Africa. However, other mechanisms of rock bursting, such as shear failure and slip, are not addressed by the energy release rate (ERR) index. Such mechanisms have been identified in the Coeur d'Alene Mining District where the greatest premining stress is horizontal compression (10). Recent research (19) on explicit modeling of shear fractures has also pointed toward adopting the underhand longwall method as a means of reducing rock burst hazards.

However, these studies were based on the assumption that backfill behavior does not differ appreciably between the overhand and underhand methods. Experience with backfill in the LFUL stope showed that while overhand stopes are easy to fill completely, it is difficult to fill underhand stopes completely. Several researchers, including Salamon (16), have expressed concern that the resulting gap may seriously increase the rock burst hazard. A

³Italic numbers in parentheses refer to items in the list of references at the end of this report.

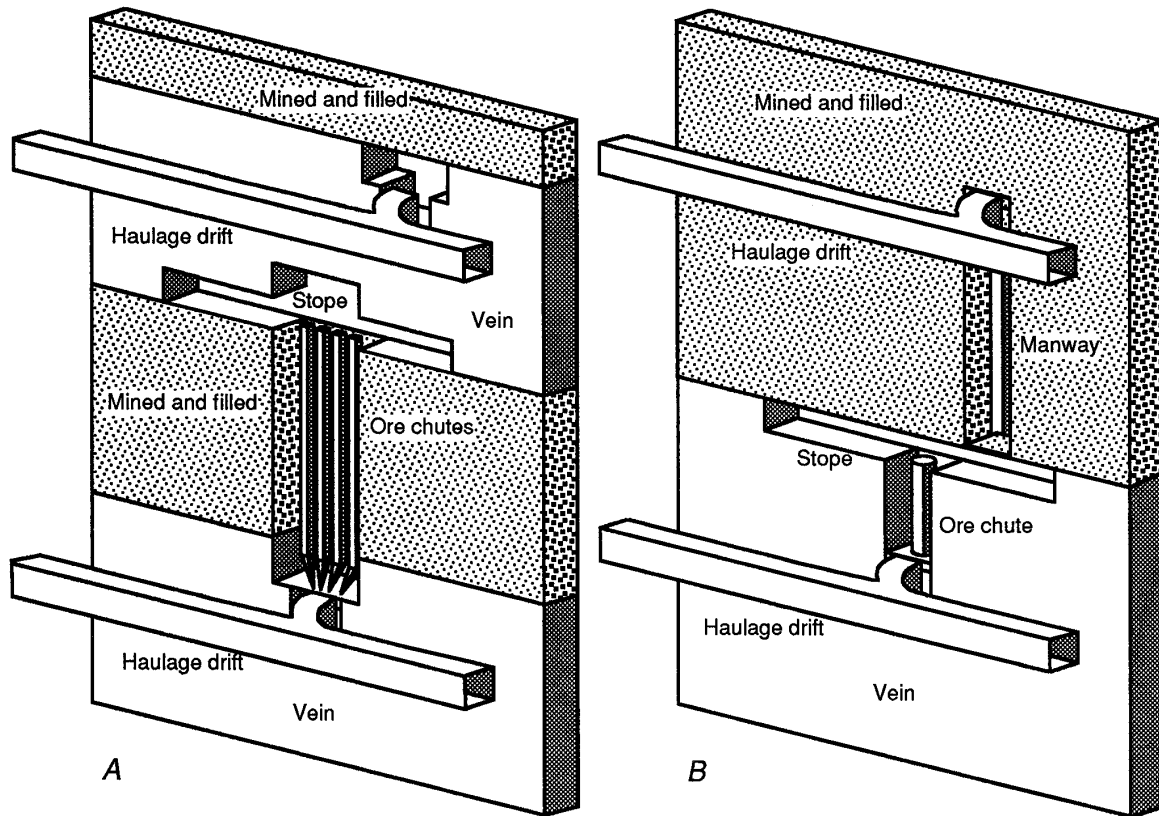

Figure 1.—Schematic of cut-and-fill mining methods. A, Overhand; B, underhand.

recent study by Hedley (8) showed that increasing stope height in an overhand cut-and-fill stope, which is analogous to placing backfill with a temporary gap, significantly influenced rock bursting.

This report examines the influence of this gap, as well as the influence of cement content and degree of fill consolidation, on rock burst potential as measured by the ERR. The purpose is to evaluate the relationship between

backfill practice and rock bursting in underhand longwall stopes. Other Reports of Investigations in this series describe the overall LFUL stope investigation (20) and calibration of a stope-scale numerical model (13). Additional information on stope design and operation were reported by Werner (17) and Noyes, Johnson, and Lautenschlaeger (12), respectively.

ACKNOWLEDGMENTS

Close cooperation of the Hecla Mining Co. and the University of Idaho is gratefully acknowledged. Fred Brackebush, manager of mining research for Hecla (now president of Mine Systems Designs, Kellogg, ID), was instrumental in organizing research efforts. Dave Cuvelier and Mike Werner, mining engineers, Hecla Mining Co.

coordinated mine access. The contributions of Bureau of Mines staff, including Doug Scott, geologist, and Mark Board, mining engineer (now with Itasca Consulting Group), were invaluable to planning and monitoring the instrumented stope.

BACKFILL BEHAVIOR

Fundamental to studying the role of backfill practice in reducing rock burst hazards is an appreciation of the physical properties of a specific fill. Patchet (14) identifies fill characteristics that control behavior: particle size distribution, cement content, and density or void ratio after placement.

Since the raw material for fill is mill tailings, the particle size distribution is largely fixed. That is, the mill is not likely to modify its grinding and processing operations to satisfy fill specifications. However, it has been common practice to cyclone off slimes from the total mine tailings to make a coarser sandfill that dewateres easily. Original LFUL stope specifications called for paste fill, defined as low-water-content total mill tailings with cement added. This paste fill would have an angle of repose high enough to allow placement tight to irregular backs. Typical uniaxial compression test results for paste fill cylinders made from fine and coarse total mine tailings with 6-pct cement are shown in figure 2. For a detailed discussion of Coeur d'Alene fill characteristics, see Boldt, McWilliams, and Atkins (3).

However, at the Lucky Friday Mine, the high viscosity of this paste fill presented difficulties when it was pumped a mile down into the mine and then horizontally across levels. Viscosity was reduced by increasing water content and removing some slimes. The resulting fill was a compromise between the planned paste fill and a traditional sandfill with added cement. In initial cuts of the LFUL stope, cement was added during filling of the bottom half only, and uncemented fill was placed in the remaining void.

Stope closure and fill pressure instruments were paired for placement in both the cemented and uncemented

portions of the fill. These instruments showed that the initial increase in strength resulting from the addition of cement quickly disappeared when the backfill fractured (fig. 34). In this case, the 2 in of stope closure created by mining the following cut was more than sufficient to fracture the cemented fill completely, thus nullifying the fill's contribution to regional support before attainment of full confinement. Laboratory confined-compression tests on Coeur d'Alene backfill showed cement content had very little influence on load-carrying capacity after fracturing.

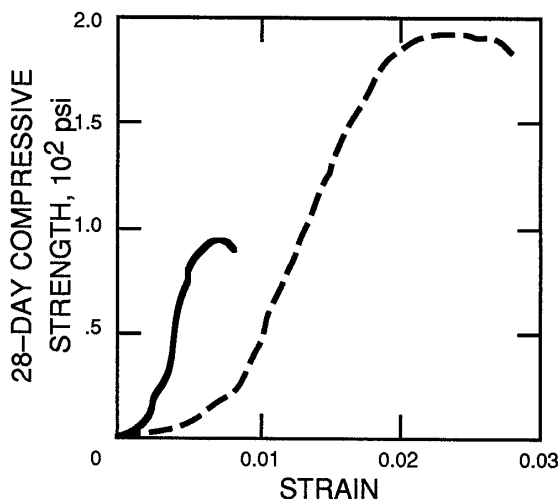

Figure 2.—Unconfined compression stress-strain curves for 6-pct cement fill using fine and coarse total mill tailings.

There was a lag between fracturing of the cemented fill and generation of significant support loads as the fill consolidated. That is, as long as the backfill particles could consolidate, or repack, to fill all void spaces, large loads could not be generated in the fill. Estimating the so-called closable void ratio of LFUL fill at placement was difficult. Consolidation of hydraulically placed sandfill

(total tailings with slimes removed) was monitored in situ by Corson and Wayment (5) in an overhand cut-and-fill stope where each cut was totally filled. In this study, the sandfill became totally consolidated at 15 pct strain (closure), which was judged to be a good, conservative estimate for the present work because the inclusion of slimes would result in a denser fill requiring less closure for consolidation.⁴

The reduction in backfill viscosity required for pumping fill into the LFUL stope through the existing system also reduced the fill's angle of repose (i.e., increased slump). Since the stope cuts are slightly inclined to provide drainage and the back is irregular, it was difficult to fill tight to the back throughout the stope. Early stope cuts were filled to within 1.5 ft of the back on the average, leaving about 15 pct of the cut as gap (fig. 4). Since the fill must close this gap as well as consolidate, the gap dramatically delayed the development of appreciable support loads. A 15-pct consolidation combined with a 15-pct gap between fill lifts combine to require roughly 30-pct closure before confined compression conditions are attained.

As part of this investigation, mine personnel agreed to take extra efforts to fill cut 10 of the LFUL stope completely and so reduced the gap to an average of less than 5 pct. Stope closure and fill pressure instrument pairs placed in this cut measured significant improvements in support pressure and a reduction in stope closure during mining of the following cut (fig. 3B). It would appear that the reduction in backfill gap was responsible for the improvement. Although variations in lithology and geologic structure between cuts 1 and 10 might have affected these measurements, the simultaneous increase in support pressure and reduction of closure demonstrated that cut 10 backfill was performing significantly better than cut 1 backfill.

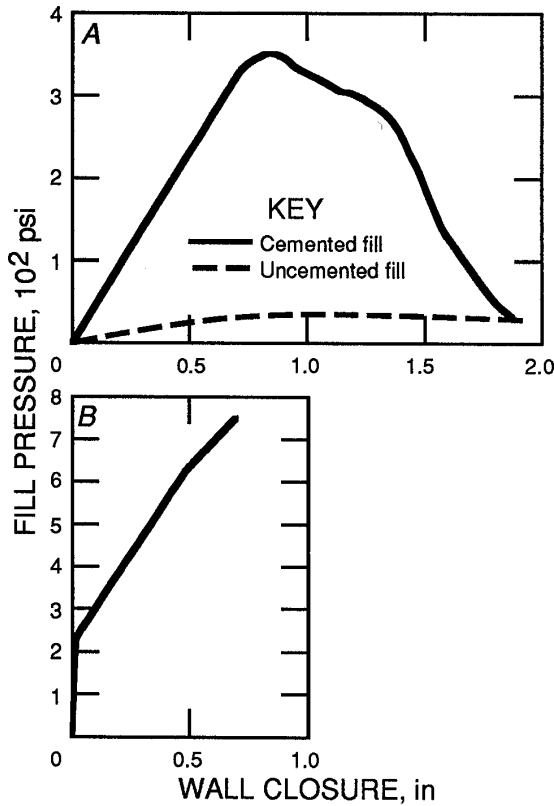

Figure 3.—Measured stope closure-fill pressure curves responding to excavation of following cut in LFUL. A, Cemented and uncemented fill placed with no gap, cut 1; B, cemented fill placed with no gap, cut 10.

⁴Methods for placing fill at close-to-maximum density have also been investigated. For instance, Corson (4) reported an increase from the normally observed 85 pct of maximum density to about 91 pct with the use of vibrators during hydraulic placement of sandfill.

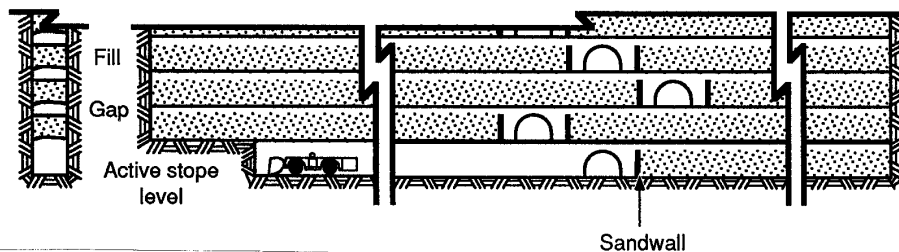

Figure 4.—Backfill placement in typical underhand stope cross and longitudinal sections. Stope gradation for drainage and uneven backfill complicate filling operations.

NUMERICAL ANALYSIS OF EFFECTS OF PLACEMENT GAPS IN FILL

A numerical investigation of cemented fill behavior in an underhand stope was undertaken using an experimental strain-softening constitutive law implemented in the finite-difference program FLAC (fast Lagrangian analysis of continua) (7). Since FLAC does not model consolidation, strain-to-consolidation must be modeled as an additional gap in the backfill. Standard elastic parameters and a Mohr-Coulomb strength criterion with cohesion-softening plasticity (table 1) were defined to match typical laboratory tests (fig. 5). Recent numerical modeling efforts (19) have shown that such a procedure will produce sample shape effects similar to those observed in laboratory tests. However, this procedure must be considered experimental because of mesh effects on softening.

**Table 1.—Backfill properties used
in FLAC numerical simulations
of stope and gap closure**

Property	Value
Shear modulus psi ..	3,200
Bulk modulus psi ..	9,300
Cohesion ^{1, 2} psi ..	30
Friction angle ² deg ..	37
Density lb/ft ³ ..	125

¹Cohesion varies linearly from 30 psi at 0 pct plastic strain to 0 psi at 4 pct plastic strain.

²Estimated values taken from backfill of similar composition (2).

A FLAC grid was defined with several fill levels and intervening gaps (fig. 6A) to examine variations in the stope closure-fill pressure relationship when the unfilled volume was changed. Support hardware (including rock bolts, timber, and wire mesh) in the stope and fill were ignored in this model. These elements play a structural role but only initially; their primary effect is to maintain a safe working back during mining of the following cut.

Program logic automatically accounted for large strains and detected contact between fill pillars as gaps closed.

Once contact was detected, normal and shear forces were transmitted across the interface. Thus, the model followed the transition from unconfined to fully confined compression. A series of grid plots for the 10-pct-gap case shows this progression (fig. 6B).

Complete stress-strain curves (fig. 7) were developed for this progression using backfill gaps of 0, 10, and 20 pct. In the numerical model, the plotted stresses were calculated for the center of the fill pillars so that plotted measurements could be compared with field measurements. Thus, these stresses were slightly larger than average support pressures.

The 10- and 20-pct-gap curves peaked initially at approximately 350 psi. The model pillar, with a 1:1-aspect ratio, was appropriately stronger than the reference 2:1-aspect ratio of the simulated laboratory test sample and compared well with field measurements of 350 psi peak pressure. The 3-pct strain shown by the model at peak load was somewhat greater than the 0.7 to 1.2 pct measured in the stope (0.8 to 1.5 in for a 10-ft-wide stope)

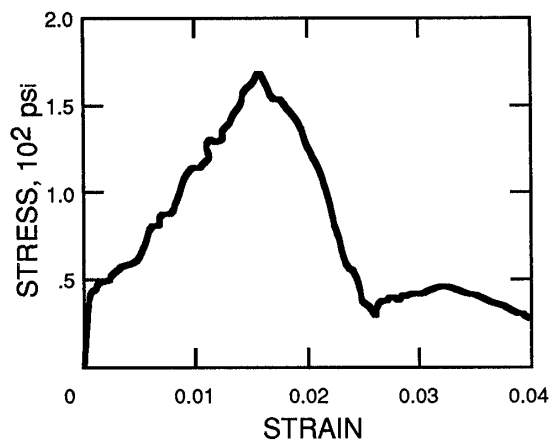

Figure 5.—Numerical model simulation of unconfined compression test with backfill properties.

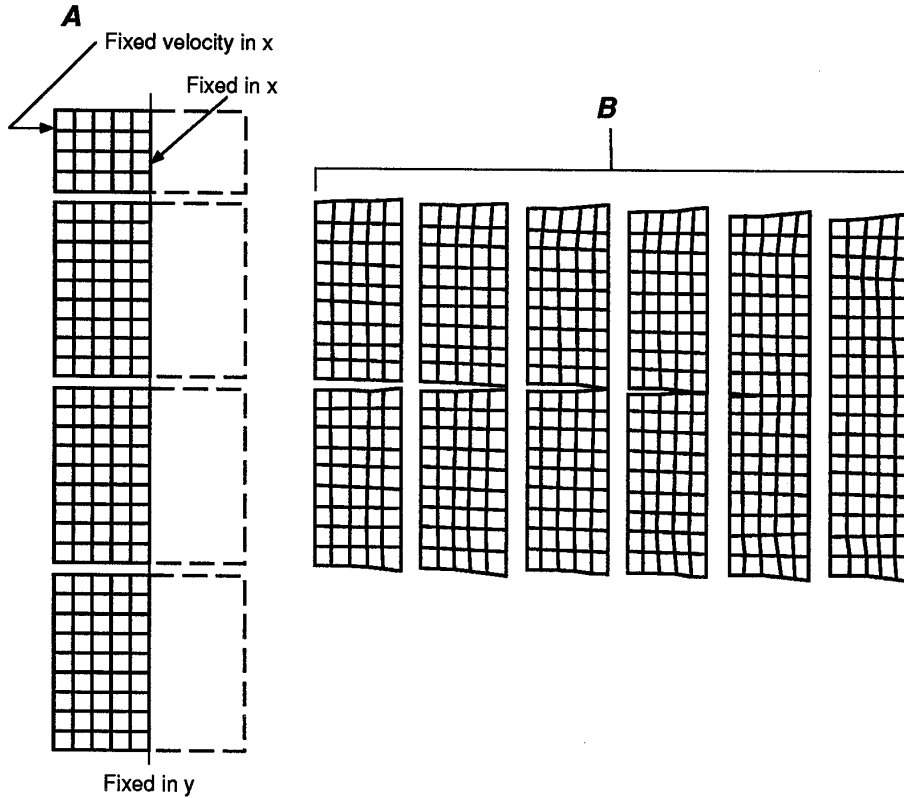

Figure 6.—Original problem mesh (A) and deforming paste fill pillars (B) during numerical model simulation of stope closure. Closure is simulated with displacement boundary conditions.

and the 1.5 pct strain-to-failure for the laboratory test model. These discrepancies were caused in part by the laboratory and field fills being composed of slightly different materials and in part by mesh dependency problems in the experimental constitutive law (19). Corson and Wayment (5) reported lateral pressures of 350 to 500 psi after closures of 14 to 18 pct in sandfill placed at 85 pct of maximum density (a 15-pct effective gap in the model) in overhand stopes at the Lucky Friday Mine. This range of values lies between the 10- and 20-pct curves shown in figure 7 for paste fill.

The perfectly placed paste fill model (no gaps and maximum density) represented conditions very similar to those established for confined compression laboratory tests on fully consolidated samples. Because the fill was totally confined, loss of cohesion with plastic strain was overwhelmed by the increase in frictional resistance. In models with gaps of 10 and 20 pct, there was a low-strength region between the initial peak strength and the onset of confined compression with contact between fill pillars.

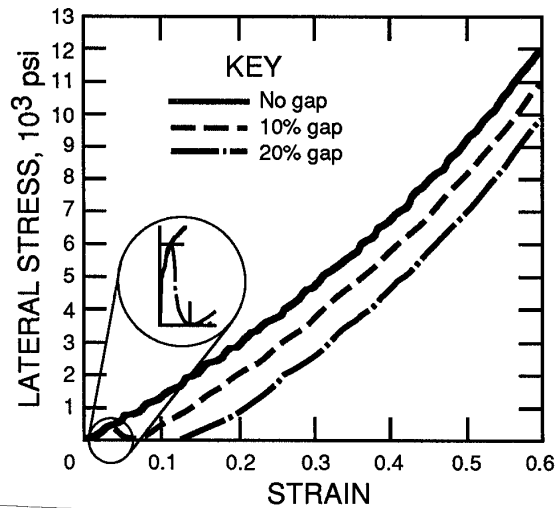

Figure 7.—Stress-strain response at center of model backfill pillar.

STOPE MODEL PARAMETRIC STUDY

Backfilled stopes in deep mines provide an abutment behind mining that will take on stress, thereby reducing stress concentrations at the mining face. The problem of locating the backfill abutment, and the effects of rock mass and backfill properties on this location, can be addressed with numerical models. However, recent work by Barrett, Kirsten, and Stacey (1) has shown that traditional models based on an elastic or elastoplastic constitutive law underestimate closure and hence the development of backfill pressure.

In the third report of this series, this shortcoming is addressed by reducing rock mass stiffness and strength to replicate field measurements in a three-dimensional, finite-element model (13), a procedure referred to as model calibration. This model follows mining of the first 10 cuts of the LFUL stope in considerable detail, but does not include a backfill model. Backfill was not considered important because 10 cuts was a clearly insufficient span over which to develop a fully confined backfill abutment, especially when the backfill gap was considered.

Experimental numerical models that simulate fracture zone behavior (e.g., 1) are another alternative. They have shown that backfill does reduce rock bursting, even for short roof spans. For this investigation, however, the time and effort involved in applying an experimental fracture zone modeling method were excessive.

Rather than adding a backfill model and expanding the scope of an already large calibrated model, or applying an

experimental numerical model, simple two-dimensional models were used in a comparative analysis of a highly idealized geometry. This approach sacrifices precision in modeling the LFUL stope for a very considerable reduction in analytical effort. Besides, as the underhand longwall method is adopted mine-wide, the series of adjacent stopes will extend about 1,500 ft on strike, which is moving toward the long-slit, two-dimensional case assumption in a vertical cross section.

The first two-dimensional model explored the sensitivity of stope closure to rock mass properties. The model was formulated with the FLAC program used previously with the mesh shown in figure 8 (which was halved along its line of symmetry). The perfect backfill force-displacement curve from figure 7 was approximated by a piecewise linear spring across the vein.

Initially, a 1,300-ft-tall by 10-ft-wide portion of the mesh was mined and filled to represent prior mining. The model was then used to follow the development of stress concentrations at the face and loading of the fill. Since shear components of the in situ stress field have little influence on these factors, the stope section was assumed to be oriented with the principal stress directions. Principal stresses of 4,500 psi vertical and 9,000 psi horizontal were assumed on the basis of a survey of overcoring measurements (18).

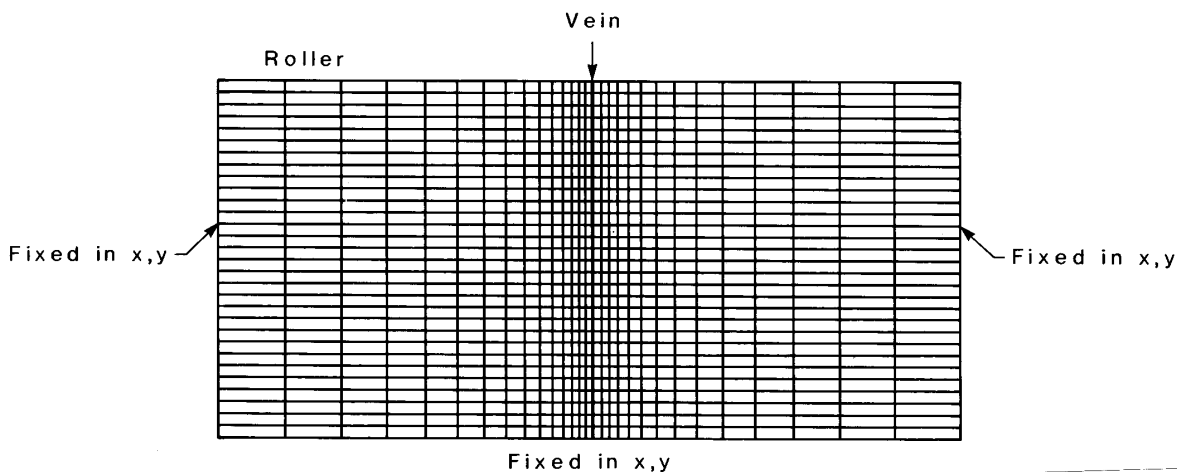

Figure 8.—Large-scale finite-difference mesh for vertical cross section of LFUL. Vein is 10 ft wide in a mesh 4,000 ft wide by 1,300 ft high. Mining progresses 650 ft down vein.

Model properties were chosen in an attempt to cover the range of probable rock mass property values for formations in the Coeur d'Alene Mining District (table 2). A Mohr-Coulomb failure criterion was used for those runs allowing rock mass failure. A further simplification was made by considering only the extreme cases of perfect-backfill models (fully consolidated fill with no gap), as approximated by a linear spring, and no-backfill models. This simplification was forced by the inability of the program to use the nonlinear backfill response curves developed for backfill with gaps.

Table 2.—Rock mass properties used to model cross section of underhand stope

Property	Value
Shear modulus psi . .	1,250,000
Bulk modulus psi . .	16,700,000
Cohesion psi . .	1,500-3,000
Friction angle deg . .	30-40

The following assumptions were made for the six model runs:

1. Elastoplastic rock mass with a cohesion of 1,500 psi, friction angle of 40°, and no backfill (these are considered to be realistic rock mass properties).
2. Elastoplastic rock mass with a cohesion of 1,500 psi, friction angle of 30°, and backfill (this run checks fill performance when a weak rock mass is assumed).
3. Elastic rock mass, backfill.
4. Elastic rock mass, no backfill.
5. Elastoplastic rock mass with a cohesion of 1,500 psi, friction angle of 40°, and backfill (model 1 with backfill).
6. Elastoplastic rock mass with a cohesion of 3,000 psi, friction angle of 40°, and backfill (this model checks backfill performance when the strongest rock mass is assumed).

Figures 9 and 10 show the half-closure (i.e., closure divided by 2) of the stope as a function of distance from stope midspan and horizontal stress from the stope face

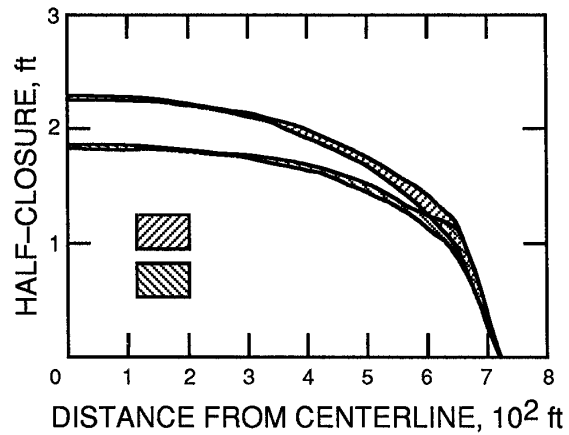

Figure 9.—Range of stope half-closures for various rock mass property and fill assumptions.

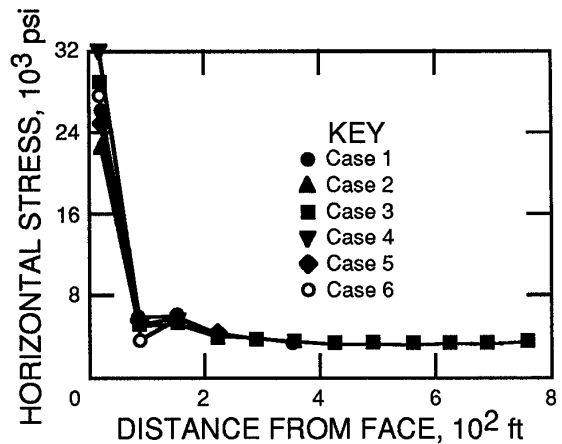

Figure 10.—Horizontal stress at stope face for various models.

for all six models. The effective ground support pressure generated by the fill as a function of distance from the face is shown in figure 11. The effective ground support pressure was calculated by dividing spring force by load-bearing area (approximately 10 ft²).

The following conclusions were drawn from this model study.

1. There was little difference in stope closure between the elastic and the elastoplastic models. The yield zone surrounding the stope was limited and resulted in only slightly greater closures.

2. The closure of the stope was, however, affected by backfill. Closure at midspan was reduced by roughly 20 pct. Fill strain was approximately 35 pct at midspan, decaying only near the mining face.

3. Backfilling reduced rock mass stress by roughly 10 pct immediately ahead of the face, but there was virtually no difference 60 ft from the face.

4. The various rock mass property assumptions caused only minor changes in backfill performance.

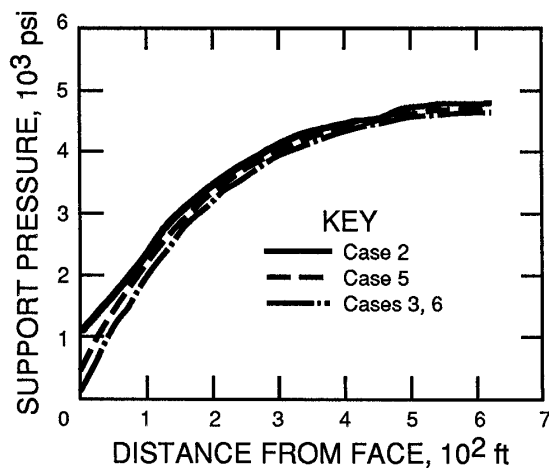

Figure 11.—Effective fill support pressure.

ROCK BURST HAZARD STUDY

Assessing rock burst hazards for a mining system is far from an exact science. Factors contributing to this uncertainty include the variety of rock burst mechanisms that may be active, the lack of knowledge about these mechanisms, and the tendency of rock bursts to be associated with unusual localized conditions rather than average rock mass conditions.

One existing technique for comparing the relative rock burst hazard is the empirical ERR index (15). ERR is a measure of the energy change accompanying an increment of mining, and is calculated as one-half the product of the preexisting tractions on the block mined and the change in closure divided by the area of the block mined.

The ERR index was developed and implemented in South African mines that have fairly simple geology and has been linked directly to the overall level of rock burst activity in these mines, primarily in pillars or ribs. As such, it should provide some relative indication of the effect of various backfill gaps on the level of rock burst activity. Using the ERR index in the Coeur d'Alene Mining District, which has significantly different conditions from those found in South Africa and possibly different rock burst mechanisms (16), introduces some uncertainty, especially in regard to the absolute level of rock bursts activity. However, the ERR index is useful as a *relative* measure of activity. That is, if two mining schemes are compared, the option with a significantly lower ERR index should have fewer rock bursts.

The displacement-discontinuity, boundary-element program MINAP (6) was chosen to calculate ERR for the various gap proportions. This program assumes the rock mass to be an elastic continuum, which the second FLAC study showed to be appropriate. The nonlinear backfill force displacement curves in figure 7 developed with the first FLAC model were entered into MINAP as best-fit, second-order polynomials. MINAP underhand mining models were run with backfill load-deformation responses representing no fill, no gap, 10 pct gap, 20 pct gap, and an extrapolated 30 pct gap. The ERR results are presented as the relative percentage change from the present practice case (30 pct gap including consolidation), since a correlation between magnitude of ERR and rock burst hazard has yet to be established in the Coeur d'Alene Mining District. The results were that:

1. Underhand mining without backfilling increased the ERR by 42 pct over the ERR with present practice. Thus, present backfill practice provides an important contribution to the reduction of rock burst hazards.

2. Reducing the stope closure required for the backfill to attain confined compression conditions (either by filling the gap or densifying the backfill) by 1 pct reduced the ERR about 1 pct. Implementing an ideal backfill practice (no gaps and full consolidation) would reduce the ERR by 28 pct over present practice.

DISCUSSION AND CONCLUSIONS

This analysis of underhand backfill practice in the Coeur d'Alene Mining District shows that backfill contributes substantially to reducing rock burst hazards. Numerical modeling studies indicated that omitting backfill altogether increased the ERR by 42 pct, whereas modifying backfill placement practice could reduce ERR by as much as 30 pct. The easiest measure would be to reduce the unfilled void between cuts; complete elimination of this space, typically 15 pct of stope volume, could reduce the ERR by 14 pct. A further, but more costly, measure would be densification of the backfill. Finally, there was no indication that the initial strength gained by the addition of cement to form lean cemented backfill mixes provided any reduction in the ERR.

In applying these results to a particular mine, special attention should be paid to the fact that the two-dimensional numerical models used in this analysis assume

a very long vein that is capable of attaining complete closure for a significant length without end effects. Also, the ERR method is aimed primarily at rock bursts caused by pillar and abutment-crushing rock burst mechanisms, but does not apply directly to discontinuity slip-type rock bursts.

Finally, this analysis pointed out the importance of developing rock burst hazard assessment methods, like ERR, that are empirically linked to rock burst experience outside of South African mines. Bureau of Mines research is examining hazard assessment methods at the Lucky Friday mine for application in the deep mines of the Coeur d'Alene District of northern Idaho.

REFERENCES

- Barrett, A. J., H. A. D. Kirsten, and T. R. Stacey. Backfilling in Deep Level Tabular Stopes. Ch. in *Innovations in Backfill Technology* (Proc. 4th Int. Symp. on Mining with Backfill, Montreal, QU, Oct. 2-5, 1989). A. A. Balkema, 1989, pp. 177-186.
- Board, M. P., and S. L. Crouch. The Physical, Mechanical and Hydrologic Properties of Backfills From the West Driefontein Mines. Available from Dep. of Civ. and Min. Eng., Univ. MN, Minneapolis, MN, 1984, 23 pp.
- Boldt, C. M. K., P. C. McWilliams, and L. A. Atkins. Backfill Properties of Total Tailings. BuMines RI 9243, 1989, 21 pp.
- Corson, D. R. Field Evaluation of Hydraulic Backfill Compaction at the Lucky Friday Mine, Mullan, Idaho. BuMines RI 7546, 1971, 24 pp.
- Corson, D. R., and W. R. Wayment. Load-Displacement Measurement in a Backfilled Stope of a Deep Vein Mine. BuMines RI 7038, 1967, 51 pp.
- Crouch, S. L. Analysis of Stresses and Displacements Around Underground Excavations: An Application of the Displacement Discontinuity Method. Univ. MN Geomechanics Rep., Dep. of Civ. and Miner. Eng., Minneapolis, MN, 1976, 268 pp.
- Cundall, P., and M. P. Board. A Microcomputer Program for Modelling Large Strain Plasticity Problems. Ch. in *Numerical Methods in Geomechanics*, ed. by G. Swododa (Proc. 6th Int. Conf., Apr. 11-15, 1988, Innsbruck, Austria). A. A. Balkema, 1988, pp. 230-238.
- Hedley, D. G. F. Utilization of Backfill Support in Longitudinal Cut-and-Fill Mining. Can. Cent. for Miner. and Energy Technol., Min. Res. Lab., Elliot Lake, ON, Rep. MRP/MRL 84-76 (TR), 1984, 16 pp.
- High-Level Committee on Rockbursts and Rockfalls. An Industry Guide to the Amelioration of the Hazards of Rockbursts and Rockfalls. Chamber of Mines of S. Afr., Johannesburg, S. Afr., 1977, 123 pp.
- Jenkins, F. M., T. J. Williams, and C. J. Wideman. Analysis of Four Rock Bursts in the Lucky Friday Mine, Mullan, Idaho, USA. Paper in *International Deep Mining Conference: Technical Challenges in Deep Level Mining*, ed. by D. A. J. Ross-Watt and P. D. K. Robinson (Johannesburg, S. Afr., Sept. 17-21, 1990). S. Afr. Inst. of Min. and Metall., Johannesburg, S. Afr., 1990, v. 2, pp. 1201-1212.
- McMahon, T. Rock Burst Research and the Coeur d'Alene District. BuMines IC 9186, 1988, 49 pp.
- Noyes, R. R., G. R. Johnson, and S. D. Lautenschlaeger. Underhand Stopping at the Lucky Friday Mine in Idaho. Pres. at 94th annu. meet. NW Min. Assoc. (Spokane, WA, Dec. 2, 1988). Paper No. 12, 8 pp.; available from J. K. Whyatt, Spokane Research Center, BuMines, Spokane, WA.
- Pariseau, W. G., J. K. Whyatt, and T. J. McMahon. Rock Mechanics Investigations at the Lucky Friday Mine (In Three Parts): 3. Calibration and Validation of a Stope-Scale, Finite-Element Model. BuMines RI 9434, 1992, 16 pp.
- Patchet, S. J. The Use of Fill for Ground Control Purposes. Chapter 11 in *Rock Mechanics in Mining*, ed. by S. Budavari Practice. S. Afr. Inst. Min. and Metall., Johannesburg, S. Afr., Monograph Series No. 5, 1983, pp. 241-255.
- Salamon, M. D. G. Rock Mechanics of Underground Excavations. Chapter in *Proceedings of the 3rd Congress of the International Society for Rock Mechanics* (Denver, CO, 1974). Nat. Acad. Sci., Washington, DC, pp. 951-1099.
- Salamon, M. D. G. (CO Sch. Mines). Personal communication, 1988.
- Werner, M. A. The Lucky Friday Underhand Longwall Mining Method. Ph. D. dissertation, Univ. of ID, Moscow, ID, 1990, 132 pp.
- Whyatt, J. K. Geomechanics of the Caladay Shaft. M. S. thesis, Univ. of ID, Moscow, ID, 1986, 195 pp.
- Whyatt, J. K., and M. P. Board. Numerical Exploration of Shear-Fracture-Related Rock Bursts Using a Strain-Softening Constitutive Law. BuMines RI 9350, 1991, 14 pp.
- Williams, T. J., J. K. Whyatt, and M. E. Poad. Rock Mechanics Investigations at the Lucky Friday Mine (In Three Parts): 1. Instrumentation of an Experimental Underhand Longwall Stope. BuMines RI 9432, 1992, 26 pp.