

# **AN EVALUATION OF LEAKY FEEDER COMMUNICATION IN UNDERGROUND MINES**

## **FINAL REPORT**

**By:**

**Dana T. Updyke  
Wayne C. Muhler  
Howard C. Turnage**

**Prepared for:**

**United States Department of the Interior  
Bureau of Mines**

**Contract No.: JO 199048**

**June 1980**

The views and conclusions contained in this document are those of the authors and should not be interpreted as necessarily representing the official policies or recommendations of the Interior Department or of the U.S. Government.

Reference to specific brands, equipments or trademarks in this report is made to facilitate understanding and does not imply endorsement by the Bureau of Mines.

1. Report No.		2.		3. Recipient's Accession No.	
4. Title and Subtitle <b>An Evaluation of Leaky Feeder Communication in Underground Mines</b>				5. Report Date <b>June 1980</b>	
7. Author(s) <b>D. T. Updyke, W. C. Muhler, H. C. Turnage</b>				6.	
9. Performing Organization Name and Address <b>Atlantic Research Corporation 5390 Cherokee Avenue Alexandria, Virginia 22314</b>				8. Performing Organization Report No.	
12. Sponsoring Organization Name and Address <b>United States Department of the Interior Bureau of Mines, Pittsburgh Research Center Cochran's Mill Road, P.O. Box 18070 Pittsburgh, Pennsylvania 15236</b>				10. Project/Task/Work Unit No.	
				11. Contract or Grant No. <b>JO 199048</b>	
				13. Type of Report <b>Final Report</b>	
15. Supplementary Notes <b>Bureau of Mines Contract Manager: James C. Cawley</b>					
16. Abstract <p>The objective of this project was to develop technical data and evaluate performance and utility of leaky feeder communications systems currently used in North American underground mines. The desired information was obtained principally through on-site surveys. Altogether, six of the seven mining companies known to be using leaky feeder communications were visited. This report covers the findings of these surveys. In addition, the report provides a brief background summary of mine communications, a technical discussion of leaky feeder systems, and conclusions and recommendations based on the results of the survey.</p>					
17. Originator's Key Words <b>Mine communications, leaky feeder communications, tunnel communications, leaky feeder cable, leaky feeder systems, induction cable, radio communications in mines</b>				18. Availability Statement	
19. U. S. Security Classif. of the Report <b>Unclassified</b>		20. U. S. Security Classif. of This Page <b>Unclassified</b>		21. No. of Pages <b>102</b>	22. Price

## FOREWORD

This report was prepared by Atlantic Research Corporation, Telecommunications Department, Alexandria, Virginia 22314 under US Bureau of Mines Contract No. JO199048. The contract was initiated by the Pittsburgh Research Center. It was administered under the technical direction of US Bureau of Mines, PRC, with Mr. James C. Cawley acting as Technical Project Officer. Mr. Francis M. Naughton, Branch of Procurement, Washington, was the contract administrator for the US Bureau of Mines. The period of performance on this project was August 1979 to June 1980.

## **ACKNOWLEDGEMENT**

We wish to express our appreciation to those mining companies without whose cooperation the project would not have been possible. Our thanks also go to those individual mine employees who took precious time from their busy schedule to participate.

Every effort has been made to protect the anonymity of those companies and individuals who took part.

# TABLE OF CONTENTS

	<b>Page</b>
FOREWORD . . . . .	3
ACKNOWLEDGEMENT . . . . .	4
EXECUTIVE SUMMARY . . . . .	10
1.0 INTRODUCTION AND BACKGROUND . . . . .	19
1.1 Introduction . . . . .	19
1.2 The Need for Communications . . . . .	19
1.3 General Types of Mine Communications Systems . . . . .	20
1.3.1 Bell Signalling Systems . . . . .	20
1.3.2 Pager Phone Systems . . . . .	20
1.3.3 Dial Telephone Systems . . . . .	20
1.3.4 Carrier Current Radio Systems . . . . .	21
1.3.5 VHF/UHF Two-Way Radio Systems . . . . .	21
1.4 General Description of a Leaky Feeder Radio System . . . . .	22
1.4.1 Components . . . . .	22
1.4.2 Configurations . . . . .	23
1.4.3 Uses of Leaky Feeder Systems . . . . .	24
2.0 TECHNICAL DISCUSSION OF LEAKY FEEDER SYSTEMS IN MINES . . . . .	25
2.1 Propagation in Tunnels and Mines . . . . .	25
2.2 Leaky Feeder Cables . . . . .	27
2.2.1 Background . . . . .	27
2.2.2 Cable Types and Characteristics . . . . .	28
2.2.3 Cost Comparisons of Cables . . . . .	31
2.3 Single Repeater Systems . . . . .	32
2.4 Multiple Repeater System . . . . .	34
2.5 Alternative Leaky Feeder Configurations . . . . .	34
3.0 SURVEY FINDINGS . . . . .	38
3.1 Description of the Survey . . . . .	38
3.2 Mine Survey Findings . . . . .	39
3.2.1 Survey Data – Mine A . . . . .	39
3.2.2 Survey Data – Mine B . . . . .	50
3.2.3 Survey Data – Mine C . . . . .	59
3.2.4 Survey Data – Mine D . . . . .	67
3.2.5 Survey Data – Mine E . . . . .	75

**TABLE OF CONTENTS (Continued)**

	<b>Page</b>
3.2.6 Survey Data – Mines F and G . . . . .	82
4.0 CONCLUSIONS . . . . .	89
4.1 Summary of Leaky Feeder Use and Justification . . . . .	89
4.2 Procurement Practices . . . . .	91
4.3 Installation Practices . . . . .	92
4.4 Maintenance . . . . .	92
4.5 Training . . . . .	93
4.6 Miner Attitudes and Acceptance of Radio Communications . . . . .	94
4.7 Cost Effectiveness . . . . .	95
4.8 Intangible Benefits . . . . .	96
4.9 Alternative Forms of Communications . . . . .	97
5.0 RECOMMENDATIONS . . . . .	98
5.1 For Mine Owners and Operators Considering the Use of Underground Radio Communications . . . . .	98
5.2 For Bureau of Mines Sponsorship of Activities Leading Toward the Lowering of Cost or Increasing the Benefits of Leaky Feeder Cable in Underground Mining . . . . .	99
REFERENCES . . . . .	100

## LIST OF ILLUSTRATIONS

Figure		Page
2.1	Commercially Available Cable Antenna Types . . . . .	30
2.2	Single Repeater System . . . . .	33
2.3	Typical Multiple Repeater Systems . . . . .	35
2.4	Daisy Chain Systems . . . . .	37
3.1	System Layout, Mine A . . . . .	40
3.2	Primary Haulage Dispatch Console on the Haulage Level at the Loading Drifts . . . . .	42
3.3	UHF Repeater at the Haulage Dispatch Center . . . . .	42
3.4	Railroad Style UHF Antenna Mounted on Haulage Motor . . . . .	43
3.5	Railroad Style UHF Mobile Radio Control Head in Cab of Haulage Motor . . . . .	43
3.6	Railroad Style UHF Mobile Radio Mounted under Motor Operator's Seat . . . . .	44
3.7	Cable Trays Carrying all Cables, Including Radiax Mounted in Roof on the Main Haulage Tunnel. Tray also Supports Trolley Power System . . . . .	44
3.8	Blasting Damage Done to Unprotected Radiax in Loading Drifts . . . . .	46
3.9	New Method of Protecting Radiax in Blasting Areas, Insalled within Fabric Reinforced Hose . . . . .	46
3.10	In-house Radio Maintenance Work Area . . . . .	48
3.11	VHF Repeater, Wall Mounted (Front View) . . . . .	51
3.12	VHF Mobile Radio Mounted under the Dash of a Maintenance Jeep . . . . .	53
3.13	Railroad Style VHF Antenna Mounted on the HOod of a Maintenance Jeep . . . . .	53
3.14	1:2 Balun . . . . .	54



**LIST OF ILLUSTRATIONS (Continued)**

<b>Figure</b>		<b>Page</b>
3.15	Method of Mounting Twin-lean Antenna Cable to Top of Entrance, Turn Lead is to Right of Large Power Cables . . . . .	54
3.16	Ore Haulage Belt and Drive Motors . . . . .	56
3.17	VHF Repeater with Convection Cooling Vents Sealed to Protect from Dust . . . . .	56
3.18	Repeater Cabinet Located Adjacent to the Haulage Belt (Radio was Cleaned Less Than 60 Days Earlier) . . . . .	57
3.19	System Layout, Mine C . . . . .	61
3.20	Primary Dispatch Console Located in the Hoist House . . . . .	63
3.21	Typical UHF Mobile Radio Package Used on Personnel Haulage Motors (Radio, Enclosure, Control Head and Antenna) . . . . .	63
3.22	Internal View of Custom Radio Enclosure. Power Supply/Battery Charger on Door, 12 VDC Battery on Left End, and Modified Mobile Radio on Right . . . . .	66
3.23	Snapper, Hooking and Unhooking Cars, with UHF Portable Radio in Upper Right Pocket . . . . .	66
3.24	System Layout, Mine D . . . . .	69
3.25	Railroad Style VHF Antenna Mounted on Battery Operated Rail Motor . . . . .	71
3.26	Railroad Style Mobile Radio Mounted in Electrical Compartment of Rail Motor . . . . .	71
3.27	System Layout, Mine E . . . . .	76
3.28	Photo of Underground UHF Repeater . . . . .	78
3.29	Repackaged UHF Mobile Radio for use on Mine Vehicles . . . . .	78
3.30	Splitter Installed in Radiax Line . . . . .	80

**LIST OF ILLUSTRATIONS (Continued)**

<b>Figure</b>		<b>Page</b>
3.31	Radiax, Improperly Bent and not Properly Terminated . . . . .	80
3.32	System Layout, Mines F and G . . . . .	83
3.33	Radio Equipment Inside Manstrip Cab . . . . .	84
3.34	Photo of Rear Cab Area of Supply Motor. Hard Hat Mounted in Electrical Box . . . . .	84
3.35	Processing Plant Located in Ravine between the Two Sister Mines . . . . .	86
3.36	Main Entry Portal. Hard Hat Antenna Connected to Radiax is on Upper Right Rail Train Shown . . . . .	86
 <b>Table</b>		
2.1	Propagation Characteristics in a Coal Mine . . . . .	26
2.2	Propagation Characteristics in an Iron Mine . . . . .	26
4.1	Communications Systems Summary . . . . .	90

## EXECUTIVE SUMMARY

This report is the result of a project conducted by Atlantic Research Corporation under contract to the U.S. Department of Interior, Bureau of Mines. The objective of the project was to “Develop technical data and evaluate performance and utility of leaky feeder communications systems currently used in North American underground mines.”

As a general principal, radio waves do not propagate well through underground tunnels and mines at frequencies ordinarily used for communications. This fact has tended to frustrate the use of two-way radio in mines except over very short distances. However, the range of radio communications in tunnels can be greatly extended by the use of leaky feeder cables. As the name implies, “leaky feeder” cables are radio frequency transmission lines that permit, by deliberate design or otherwise, external leakage fields large enough to allow reception by mobile or portable receivers. Reciprocally, such cables are also able to pick up the transmissions of mobile or portable transmitters, thus permitting two-way radio communications with other units connected or coupled to the cable.

Serious interest in the use of leaky feeder systems in mines did not occur until the late 1960's and that primarily in Europe. Much pioneering work was sponsored by the Institute National des Industries Extractive (INIEX) in Belgium and by the National Coal Board (NCB) in the United Kingdom. A number of studies have been sponsored by the U.S. Bureau of Mines and an experimental installation was made in Bethlehem Steel Corporation's Grace Mine, near Morgantown Pennsylvania. To date, however, the use of leaky feeder systems in US mines is still rather limited.

A leaky feeder radio system, as used in a typical mine or tunnel application, can be subdivided for discussion into its major components. The major components of this type of a system are: (1) the mobile radio transceivers (transmitter/receivers), (2) the base station transceiver, (3) the remote control equipment, and (4) the leaky feeder cable antenna system. The first three components are used in much the same manner as in surface mobile radio systems. They are as a matter of fact, adaptations of equipment normally sold for use on the surface. The unique feature is the leaky feeder cable, which replaces the antenna system used with base stations above ground.

The only leaky feeder used in US mines at the time of this study was slotted coaxial cable. It is available in 1/2-inch and 7/8-inch diameter sizes and is very similar to coaxial radio frequency transmission lines used in radio base stations on the surface. It differs only in that a series of closely spaced slots has been cut into the sheath along one side of the cable. Other types of cable have been used in Canadian and European mines. Cost of the slotted coaxial cable for lengths between 5000 and 25,000 feet were quoted in May 1980 at \$1.66 per foot and \$3.32 per foot, respectively, for 1/2-inch and 7/8-inch sizes.

To carry out the survey, an exacting questionnaire was developed and a two-man survey team was assembled to personally visit selected mines known to employ some form of leaky feeder radio system. The two team members were selected with backgrounds specifically oriented toward the needs of the study. One team member was a communications engineer with experience in two-way radio systems. The second member of the team had experience in mining, mine safety and human factors relative to mining operations. During these visits mine personnel responsible for the maintenance and/or management of the radio system were interviewed. The objective of the interviews was to collect the information necessary to characterize experience with this type of system (i.e., typical advantages claimed, typical costs, typical complaints, etc.). Altogether six mining companies controlling ten leaky feeder equipped mines were interviewed. One of these was in the Rocky Mountain region of the US, one in the southwest, one in Canada, and the others were in the Appalachian region of the US. These, with one other company that declined to be interviewed, represent all the companies in North America known to have leaky feeder systems in place and operating. At least two others had used leaky feeder earlier but had since discontinued its use. One of these had used a passive system (i.e., a leaky feeder cable only – without a base or repeater station) to provide portable-to-portable communications from end to end of a longwall coal mining operation. It was discontinued when the longwall was shortened to less than 200 feet, making direct portable-to-portable contact possible without the cable. The other was a more conventional repeater system, but was reportedly discontinued because the miners rebelled against its use.

It is concluded from the survey that the use of leaky feeder communication systems in North America has been limited and has been primarily the result of legal requirements. Two-way radio communications are required on all underground rail systems in the state of West Virginia, and have been required in other areas if more than one vehicle was to use the rail system at any one time. Given the requirements for two-way radio communication, the leaky feeder system was adopted at several mine sites. Other mines adopted the leaky feeder system solely on the recommendation of their communications equipment suppliers or to keep the underground system compatible with existing surface radio systems owned by the company.

Other rationale for installing two-way radio communications systems underground include reduced mine maintenance costs reported by a large Canadian mine through better use of their mechanics and perception of increased worker safety. The mines have considered the expense of the radio systems with a cost of doing business (West Virginia mines) or a definite asset in terms of production and labor cost savings.

Because the use of two-way radio communications is not common underground, the variety of potential radio uses have not been entirely explored. Radio systems are primarily used as management tools for communication with workers in remote locations, and for traffic control on rail systems or haulage ways. The most common use of two-way radio communications underground utilizing a leaky feeder cable has been for the direction of traffic on railway systems. Use of the leaky feeder system allows continuous communications between rail vehicles and a dispatcher. This eliminates the need for rail vehicle operators to leave their vehicle to visually check each intersection prior to passing it and to coordinate and time vehicle movements so that they do not inhibit each other. Use of the leaky feeder communication system has provided effective communications on almost all rail systems employing it, and has allowed several to increase their haulage system capacity up to ten times through its use.

A second use of the leaky feeder communication system underground has been for supervision of mechanics and production workers. Use of the radio eliminates the need to travel to remote locations or to rely on pager phones for communication with workers. Mechanics and other production personnel that travel throughout the mine are much easier to locate using the radio, saving substantial amounts of "travel and location" time. Although several mines have found the leaky feeder communication system desirable from an operations viewpoint, there have been some substantial problems with installation and use of the systems.

It was observed during the survey that a number of problems could be traced to procurement practices. Basically, procurement of leaky feeder systems were initiated without a complete understanding of the capabilities or pitfalls of such systems, and without adequately defining the needs to be satisfied. It was found that:

- In-house technical expertise was generally nonexistent or simply not sufficient during the planning and/or procurement stages of the system.

- Investigation of available equipments and sources for assistance was inadequate before procurement.
- The actual procurement was, in all cases except one, executed without the benefit of comprehensive technical specifications or even performance specifications by which the end product could be evaluated.

Procurement under these conditions can be the root of subsequent difficulties such as disappointment with the system's performance and costly system reengineering to correct original design deficiencies.

The design and installation of the systems reviewed for this project indicate a wide variation in concern for maintenance and durability. Few systems have been specifically designed for the extremely rugged environment and the rough handling received by the untrained users. Although several systems were installed in locations that afforded the radio protection from falling objects and physical abuse, accessory components such as microphones and speakers were substantially less protected. It is also apparent that several installations were made with no concern for ease of maintenance. Radios were installed in locations difficult to reach or in such a manner that they require a significant amount of work to remove.

Repeater station installations could be improved by providing more substantial cases with improved dust filtering capabilities. Many installations reviewed indicated a need for a cabinet which could withstand limited roof falls as well as provide clean cooling air. Cable installation and hanging techniques also varied widely by installation. It is apparent that many individuals installing the cables did not know how to correctly install the system or had not considered the possibility of physical abuse.

Only one of the mines surveyed had a complete in-house maintenance capability. Others depended wholly or partially on contract maintenance by an outside radio shop. Three of the mines did routine repairs and replacement of defective components depending on an outside shop for troubleshooting and repair of the defective components replaced. One mine not only depended wholly upon outside maintenance but exercised no coordination over calls for service. Any miner could call for service even for the replacement of a microphone. This mine complained of exorbitantly high maintenance bills and yet had the poorest maintained system of all those that were surveyed.

It was found that without exception all mines were deficient in the proper training of personnel who were to either use the radio system or be affected by its usage. This lack of training contributes directly to many problems experienced by those surveyed. Several of these problems are:

- Inefficient implementation of the entire system
- Improper usage of the system
- Abuse of the equipment and thus higher maintenance costs
- And occasionally, nearly total rejection of the new system by miners and/or mine supervisors.

Some systems are fairly complex in their operation. Therefore, lack of instruction on the simple operational characteristics of the system can cause operators to assume a system malfunction when in fact the problem may be operator error. This applies equally to the mechanical operation of a piece of radio equipment itself.

The effectiveness of the communications systems has been severely hampered at several locations due to inadequate understanding by company personnel of the requirements for the installation and maintenance of the systems. Initial startup problems characterized by repeated system failures was common at most sites visited. This severely hampered the effectiveness of the systems due to the negative impression it left on the system users. At several locations the system was not reliable enough to be used for management functions or traffic control without a backup. This led to a very poor acceptance of the system by the workers as well as management. Only after several months of system use and improvements in the in-house maintenance capability have these systems grown to be tolerated by the workers and management. For the average installation it took approximately one year for the system to become fully functional, both from a reliability and worker acceptance standpoint. Another major problem with the use of the leaky feeder systems has been a lack of understanding by both management and workers of how to use the system and its actual capability.

A consideration of cost effectiveness is a direct response to question 1 in Section 1.1 of this document. The procurement of leaky feeder was invariably associated with the objective of increasing production. Even in those mines where it is intalled merely to meet a legal requirement it is most often tied to some direct production function and not to a management or safety purpose.

At all but one location the system was perceived by management as meeting this objective. Although only one mine could show an increase in production directly attributable to the radio system, the other users also felt production was increased. In the one case, the mine considered that the radio made it possible to increase production from an annual gross of about \$2 million to nearly \$10 million. This was accomplished by a capital investment of \$800,000 and an estimated annual maintenance cost of about \$25,000. This increase in production is a direct result of the greater number of trains that can be operated on the same track because of a continuous communications capability. Other mines reported that benefits were realized because of improved haulage, supply delivery and repair.

No accidents were reported on haulage systems employing radio communications. These mines did report accident histories prior to radio installation. The reduction in accidents directly increased production. At one mine this saving, or more realistically, increase in production was substantial. Accidents prior to the radio system installation stopped production for an average of 14 days. With the current production rate of 50,000 tons per day the annual production of the mine has increased approximately 700,000 tons per year due to accident reductions.

Although no systems were purchased solely for the purpose of mine safety, nearly everyone interviewed at each mine agreed that worker safety was enhanced by the radio. The users felt that the radio would allow faster response during mine emergencies, as well as allow redirection of effort as conditions change in an emergency. The radio also serves as a backup communications system where other systems, such as telephones or pager phones, have failed. Safety aspects of the system have been the consideration for the establishment of laws requiring two-way radio communication. Personnel interviewed at the mines indicated that the radio reduces the probability of intersection collisions of rail and rubber tired vehicles. The radios allow communications between vehicles at intersections as well as allow warnings in the event of a runaway vehicle.

Some radio system users have installed leaky feeder cable to remote locations where a single person or small crew works. This allows these individuals to work in a complete contact with supervisors or other crews away from their immediate area. A simple call to these people by a supervisor confirms whether or not an unusual condition exists. The radio also allows the remote person to relay requests for assistance.

The following recommendations are directed to mine owners and operators considering the use of underground radio communications:



(1) *Radio systems require planning.* Management should acquire information on both the capabilities and limitations of radio systems from suppliers and from other mines with operating systems. If possible, a responsible representative of management should visit a mine already equipped and personally observe operations. Before proceeding with procurement, management should have prepared a performance specification defining exactly what the system is to include and what it is expected to do.

(2) *Radio systems require management.* Without an individual *in a management position* pushing for and overseeing the radio system it is doomed to failure. In systems observed where the performance was exceptional, there was always an individual who felt that he was responsible for the system and who had an interest in its best performance.

(3) *Radio systems require maintenance.* In several instances, it was found that the maintenance function was left to mine electricians who did not fully understand the radio system and thus provided poor maintenance. It is crucial that the maintenance of the system be performed by radio technicians with a knowledge of mining and its unique environment.

(4) *Users of radio equipment require training.* All underground personnel including supervisors should be thoroughly trained in proper radio use, radio communication etiquette, and operational procedures. Without thorough training of the entire underground work force the radio will be severely limited. Every individual with access to the system should know how to use it, when to use it, and its potential value to him.

Additional recommendations are made for Bureau of Mines sponsorship of activity leading toward lowering cost or increasing the benefits of leaky feeder cables in underground mining. These are:

(1) *It is recommended that alternative cable designs be investigated with a view toward reducing cable costs.* The most expensive single item in leaky feeder systems is the cable. Many designs have, in fact, been studied and no investigation should be conducted without reference to the literature on this subject. Nonetheless, a would-be user has a very limited choice of commercially available and proven designs. The investigation should include comparative tests in a mine environment of various designs, including designs and techniques used in other countries.

(2) *It is recommended that some Bureau of Mines sponsored entity be established for the provision of training and the exchange of information relating to communications and perhaps other mining technology.* In a recent report by John Short and Associates the creation for coal miners of an “extension service” patterned after the agricultural service now provided for farmers was recommended. Among the services the extension service would provide are guidance for training in mine productivity, safety and health and a means for the exchange of technology in the mining industry. This concept is endorsed with the proviso that the exchange of technology include radio communications technology, and that training include the operation and use of radio equipment.

(3) *It is recommended that support be given to the further development and improvement of bi-directional line-powered cable amplifiers (or in-line repeaters) for underground mines.* Advantages to be achieved are the elimination of multiple base station repeaters and their interconnecting audio and power lines, the reduction of required base station RF power and the reduction of RF power required of mobile and portable transceiver power. Ruggedness, reliability, intrinsic safety, and reasonable cost should be prime objectives in the development effort. Another consideration should be the use of frequency bands, such as 800 - 1000 MHz, known to have good propagation characteristics in tunnels but which are not currently used in underground mines. Full advantage should be taken of the existing cable-television technology (6 to 400 MHz) and European daisy chain repeater technology (mostly 68 to 88 MHz).

(4) *It is recommended that the development of prototype mobile and portable transceivers for underground use be undertaken.* In some mines surveyed extensive modifications to equipment designed for surface use had been made. In all mines the reliability of mobile and portable transceivers suffered in the mine environment. Emphasis should be placed on simplicity, ruggedness, and intrinsic safety. Units should be single-channel and contain an absolute minimum of controls and switches. Used with a system of in-line cable amplifiers the transceivers would require RF power outputs considerably less than one watt. The ultimate objective should be that no miner is ever out of voice contact.

(5) *It is recommended that the Bureau of Mines sponsor the development of a “recommended practices” document for the design, installation and operation of underground leaky feeder system.* The mine survey revealed a wide variability in the installation and use of leaky feeder systems and uncovered a number of poor practices, many of which had already been found and corrected by the mines in question. The document should cover possible uses and design configurations, installation practices for cable, installation practices for fixed and mobile radio, recommended operating procedures and recommended maintenance procedures. The purpose of the

document would be to provide guidance to mines which are considering the use of leaky feeder communications or which may be seeking to improve systems already installed.

## **1.0 INTRODUCTION AND BACKGROUND**

### **1.1 Introduction**

This report is the result of a project conducted by Atlantic Research Corporation under contract to the U.S. Department of Interior, Bureau of Mines. The project commenced in mid 1979. The objective of the project was to “Develop technical data and evaluate performance and utility of leaky feeder communications systems currently used in North American underground mines.” The primary goals for this project were to collect sufficient data and evaluate it for the purpose of answering the following basic questions:

1. Are leaky feeder communications systems as used to date cost effective? Are they attractive to mine operators from the standpoint of cost savings, such as would result from a reduction of required personnel or equipment, or greater labor efficiency?
2. Are there intangible benefits, such as improved safety or better working conditions, which may be worthy of consideration even though not readily amenable to a cost-benefits analysis?
3. Are there alternate forms of communications which may be as good or better in the environment studied?
4. Is there anything in the data collected, or in the larger field of propagation and leaky feeder technology that suggests possible improvements which would lower the cost or increase the benefits of leaky feeder cable in underground mining?

### **1.2 The Need for Communications**

Some form of communications between workmen and/or between work crews is an absolute necessity in order to yield a coordinated work effort. As long as workers are within voice range of each other, there is little problem. However, when workers are separated by considerable open distances or even by as little as a few feet of rock, this vocal communications is rendered useless. In a mining environment underground workers are not only separated from surface workers but are very often separated from each other.

### **1.3 General Types of Mine Communications Systems**

#### **1.3.1 Bell Signalling Systems**

The first apparent need for communications appears at the portal. Those requiring the services of the cage must somehow communicate this need to the hoistman. One early solution has been that of a signal bell system on which simple codes take on specific meanings. In later years, cage and hoist equipment have become more automated and have come to lend themselves to other forms of communications systems.

#### **1.3.2 Pager Phone Systems**

The use of telephones for underground and underground-to-surface communications is by far more simple and more consistent than bell signalling systems. Battery-powered paging telephones have replaced the magneto telephones of years past, thanks largely to the advent of transistorized circuitry and reduced power requirements.

Pager phone systems have basically two wiring configurations. The first is the party line which consists of a single No. 14 or No. 16 gauge twisted pair wire strung throughout the mine and extended to the surface. This wiring may have branches to various parts of the mine and instruments may be added anywhere along the line. A second, but less commonplace wiring configuration is a multi-line scheme in which several twisted pairs, normally 6 to 8, are strung throughout the mine. The pager phones are equipped with a line selector switch to allow the user to select the desired line on which to communicate.

#### **1.3.3 Dial Telephone Systems**

Many mining operations employ central battery powered, rotary dial PBX (Private Branch Exchange) telephone systems. The majority of these systems are in use for surface communications only as the telephone companies in the United States will not always provide underground service in all localities. There are, however, exceptions to this rule when the mine has sufficient technical manpower to install PBX equipment and lines below the surface and to maintain them. These systems lend themselves to greater versatility than pager phone systems but require a large multi-pair cable network to fulfill the needs of the mine.

#### **1.3.4 Carrier Current Radio Systems**

Carrier current radio systems were evolved to satisfy the need for continuous communications to electric powered rail vehicles. In earlier designs, a frequency modulated (FM) carrier in the range of 60 to 190 kHz is coupled directly to the trolley wire. Vehicular units in such systems are capacitively coupled to the trolley and also draw power from the trolley line. They provide satisfactory communications between dispatcher and vehicle but not between vehicles. The power rectifiers and large motors across the line are a source of electrical noise and high line attenuation, both of which limit system range. More recent innovations use a separate dedicated wire, typically AWG 12, mounted about 6 inches from the roof. The dispatcher is coupled directly to the dedicated wire. In one design, the dedicated line parallels the trolley line and communication with conventional “trolley phones” is made possible through the mutual coupling between trolley wire and dedicated line. The advantage achieved is greater range through reductions in attenuation losses. Still further advantages are achieved through a “wireless trolley phone” which employs an oblong coupling loop about 42 inches long and 10 inches across. This couples directly to the dedicated line, completely eliminating the original trolley wire as a communications link. This system results in reduced noise and reduced attenuation losses, improving range and making vehicle-to-vehicle communications possible. It also makes practical the use of carrier current communications on rubber tired trolleys and battery powered vehicles, which were excluded under the original trolley wire concept.

#### **1.3.5 VHF/UHF Two-Way Radio Systems**

Conventional two-way radio has, in the past 5 to 7 years, found its way into the mining industry. It was thought that the portability which two-way radio provides to surface vehicles and personnel would be equally beneficial to the mining community. However, radio propagation through mine tunnels at these frequencies is very poor, even in tunnels providing line-of-sight between transmitter and receiver. Bends and corners make the situation even worse. Propagation is improved by the use of leaky feeder cables suspended in the tunnels and connected to the radio base station. The cables transmit radio signals as would any ordinary cable except that the cable is intentionally designed or chosen to “leak” radio frequency fields all along its length. A mobile or portable radio on the correct frequency and anywhere within a reasonable distance of the cable can receive the signal. Conversely, the leaky feeder cable can pick up radio transmissions from mobile units and transmit them back to the radio base station. In effect, the leaky feeder cable acts as a very long antenna system which can extend many thousands feet away from the radio base station. Leaky feeder cable and systems using the cable are covered in greater detail in Section 2.0.

## **1.4 General Description of a Leaky Feeder Radio System**

### **1.4.1 Components**

A leaky feeder radio system, as used in a typical mine or tunnel application, can be subdivided for discussion into its major components. The major components of this type of a system are: (1) the mobile radio transceivers (transmitter/receivers), (2) the base station transceiver, (3) the leaky feeder cable antenna system, and (4) the remote control equipment.

#### **1.4.1.1 Mobile Radio Transceivers**

The mobile radio transceivers are of the same basic style one might expect to find in a taxi, police vehicle, or other radio equipped surface vehicle. Mobile radios are generally available in one of two hardware packaging styles, front mounted and trunk (or rear) mounted. In a front mounted radio transceiver all electronics, including the operator controls and speaker, are assembled into one chassis and is usually installed in the operator's compartment. In the case of a trunk mounted radio transceiver, the radio electronics are in a chassis which is mounted in a remote location from the operator (such as an automobile trunk, under an operator's seat or in a power compartment of a locomotive). The operator controls, including speaker, are mounted in what is termed a "control head" which is mounted in the close proximity of the operator. The radio and the control head are interconnected with a control cable. Mobile radios may be equipped for single- or multi-channel operation depending on the user's needs. Mobile radios normally require 12V DC or 48V DC power.

The mobile radio classification also includes handheld portables. Here, the entire assembly, including controls, speaker/microphone, antenna and battery power supply, is contained in one small package convenient for carrying on one's person.

#### **1.4.1.2 Base Station Transceiver**

A fixed (or base station) radio transceiver is designed for stationary operation. Electronically it is very similar to a mobile radio except it usually produces a higher RF transmit output power and is usually powered by 110V AC. The greatest difference is the addition of remote control circuitry which allows the base station to be operated from a considerable distance away (up to several miles).

#### 1.4.1.3 Leaky Feeder Cable

The only leaky feeder used in US mines at the time of this study was slotted coaxial cable. It is available in 1/2-inch and 7/8-inch diameter sizes and is very similar to coaxial radio frequency transmission lines used in radio base stations on the surface. It differs only in that a series of closely spaced slots has been cut into the sheath along one side of the cable. Other types of cable have been used in Canadian and European mines.

#### 1.4.1.4 Remote Control Units

One or more remote control units can be used to control a base station transceiver. These units are used by those generally in control of the radio system such as dispatchers or supervisors. The remote control unit is usually powered by 110V AC and is connected to the base station radio by a No. 20 gauge single twisted-pair wire.

#### 1.4.2 Configurations

In general, two-way radio systems can be categorized into two main configurations: (1) "simplex" operation and (2) "relay" (or "repeater") operation. This section will describe the basics of both configurations as a foundation for technical reference later. However, throughout this document the emphasis will be placed on *RELAY* operations as they are the most prevalent in North American underground leaky feeder radio systems.

As an illustration, a simple radio system with one fixed base station, one remote control unit several miles away, and two mobile radio units will be hypothesized. In simplex operation all radio transceivers transmit and receive on the same radio frequency, for example, 452 MHz. When the dispatcher desires to communicate with a mobile he would transmit via the base station which would radiate an RF signal on 452 MHz. Assuming either or both mobile units were within receiving range of the base station radio, they would receive the 452 MHz signal. Conversely, when the appropriate mobile operator responds to the dispatcher's call he would transmit via the mobile radio back to the base station by radiating an RF signal on 452 MHz. It is also possible for one mobile unit to communicate with the other *PROVIDING* they are within radio range of each other. If both mobile units were within range of the base station and within range of each other the second mobile unit would be able to receive both sides of the base to mobile communication. If, however, both were within range of the base station but were not within a radio range of each other, the second mobile unit would receive only the side of the communications generated by the base station.



In practice, the radio range with this system is far greater for communications between the base station and mobile units than it is between two mobile units. This occurs because base station transceivers usually have a higher transmitting power and their antenna systems are much more efficient. This is especially true when the mobile units are hand-held portables.

Relay operation capitalizes on this higher transmit power and antenna efficiency of the base station radio equipment in order to extend the useful communications range between mobile units. This is done by a method of relaying or repeating the radio signal radiated by a mobile unit. Stated simply, the base station radio simultaneously retransmits (at higher power) all signals that it receives. Since it is not feasible to receive and transmit on the same frequency, the first difference between simplex and repeater operation is that all radios in the system must transmit and receive on different radio frequencies. Going back to the example, repeater operation will now be assumed. The dispatcher now transmits via the repeater station in the same manner as before on 452 MHz and the called mobile unit receives this signal. When the called mobile unit responds it will transmit back to the repeater station on a frequency of 457 MHz. Now, however, as the dispatcher is receiving the mobile's signal, the repeater is also retransmitting (or repeating) the mobile's communications on 452 MHz. This retransmitted signal can be received by all other mobiles within communications range of the repeater. The overall result of this is that each of two mobiles needs only to be within range of the repeater to communicate with each other and not necessarily within range of each other.

### **1.4.3 Uses of Leaky Feeder Systems**

Leaky feeder radio systems are used for a number of surface communications needs. They serve as paging and maintenance communications systems in large buildings where the leaky feeder is installed the entire height of the building (i.e., in the elevator shaft). Leaky feeder systems are also used to provide communications in highway and train tunnels that are too long for the use of standard antennas.

The underground mine environment and its requirements for communications align themselves very closely with the capabilities of a leaky feeder system. Its many uses include haulage system control, maintenance personnel and equipment dispatching, production crew control and safety enhancement.

## 2.0 TECHNICAL DISCUSSION OF LEAKY FEEDER SYSTEMS IN MINES

### 2.1 Propagation in Tunnels and Mines

As a general principal, radio waves do not propagate well through underground tunnels and mines at frequencies ordinarily used for communications. This fact has tended to frustrate the use of two-way radio in mines except over very short distances. Theoretical analysis<sup>(1)(2)</sup> typically treat the tunnel as an imperfect waveguide whose walls partially absorb and partially reflect incident radio energy. Propagation is therefore a function not only of tunnel size and dimensions, but of the electrical properties of the surrounding material. Measurements of radio wave attenuation along straight tunnels does show that, as in a waveguide, attenuation expressed in decibels (dB) varies linearly with distance. Measurements also show very large losses associated with corners, bends and in fact, any deviation from a straight line. Irregularities and wall roughness also contribute to observed propagation losses. Typical results of propagation measurements in mine tunnels are shown in Tables 2.1 and 2.2. Table 2.1 is based on measurements by Goddard<sup>(3)</sup> in a large coal mine near Sesser, IL. Tunnels were 14 feet wide and 7 to 8 feet high with pillars running 60 feet by 74 feet. Polarization was observed to have a significant effect. Table 2.2 is based on data reported by Delogne and Liegeois<sup>(4)</sup> for an iron mine with tunnel cross sections of 7 meters by 8 meters (23 feet by 26 feet). Polarization was not reported, but insofar as the cross section more nearly approximates a square, there should be less sensitivity to polarization.

The total propagation loss (between isotropic antennas) is determined from both tables as follows:

$$L = L_o + (A \times D) + L_c$$

where

L = total propagation loss

L<sub>o</sub> = fixed or coupling loss

A = attenuation per 100 feet

D = distance between transmitter and receiver (in units of 100 feet)

L<sub>c</sub> = loss associated with 90 degree bend (if applicable)

**Table 2.1. Propagation Characteristics in a Coal Mine**

**7 foot by 14 foot Tunnel Cross Section**

<b>Frequency (MHz)</b>	<b>Polarization</b>	<b>Coupling Loss (dB)</b>	<b>Attenuation (dB/100')</b>	<b>Bend Loss (dB)</b>	<b>Approx. Range in Feet</b>	
					<b>Straight Line</b>	<b>One Bend</b>
200	Vertical	65	15.0	—	480	—
415	Vertical	78	6.5	35	908	369
415	Horizontal	40	5.9	35	1644	1051
1000	Vertical	65	4.3	36	1674	837
1000	Horizontal	57	2.5	38	3480	1960

**Table 2.2. Propagation Characteristics in an Iron Mine**

**23 foot by 26 foot Tunnel Cross Section**

<b>Frequency (MHz)</b>	<b>Coupling Loss (dB)</b>	<b>Attenuation (dB/100')</b>	<b>Bend Loss (dB)</b>	<b>Approx. Range in Feet</b>	
				<b>Straight Line</b>	<b>One Bend</b>
36	22	18.0	6	633	604
68	30	12.0	10	886	804
150	36	11.7	15	955	817
450	48	4.6	25	1969	1421

The above equation may not be valid for very short distances (i.e., D less than 100 feet). To understand the significance of the propagation losses in terms of the possible ranges of communications between hand-held portable radios, the following assumptions can be made:

effective radiated power: 0 dBw (1 watt)

effective receiver sensitivity: -137 dBW (1 microvolt across 50 ohms)

The maximum propagation loss would be 137 dB. From this, the maximum ranges of communication have been determined and are shown in Tables 2.1 and 2.2 for straight line communications, and with one 90-degree bend included.

The ranges shown in the tables apply to rather idealized conditions, yet they are not adequate for most mining purposes. In practice, ranges may be much smaller because of multiple bends and corners, smaller tunnel dimensions, or greater energy absorption of the surrounding material. A particular case in point is the experience of a longwall coal mining operation in Dante, Virginia. It was found that UHF portable-to-portable communications along the longwall in 38-inch coal was limited to about 250 feet.

## 2.2 Leaky Feeder Cables

### 2.2.1 Background

The range of radio communications in tunnels can be greatly extended by the use of leaky feeder cables. As the name implies, "leaky feeder" cables are radio frequency transmission lines that permit, by deliberate design or otherwise, external leakage fields large enough to allow reception by mobile or portable receivers. Reciprocally, such cables are also able to pick up the transmissions of mobile or portable transmitters, thus permitting two-way radio communications with other units connected or coupled to the cable.

An early use of leaky feeder cable was made by Halstead<sup>(5)</sup> in 1940. He used a specially designed cable installed in the George Washington Bridge between New Jersey and New York City to communicate with motorists on standard AM broadcast frequencies. A similar system was operated in the Lincoln Tunnel from 1951 to 1955<sup>(6)</sup>. It was suspended at that time only because of concern that the radio signals might detonate blasting caps during the construction of a supplementary tunnel. A further development was reported in 1956 by Monk and Winbigler<sup>(7)</sup>, who attempted to use standard coaxial cable to feed a series of closely spaced antennas providing communications with moving trains in a long tunnel. They discovered that leakage from the coaxial cable alone was sufficient for this purpose; the antennas were not necessary. They subsequently went on to find that better coupling and greater range could be achieved with a balanced twin-lead cable.

Serious interest in the use of leaky feeder systems in mines did not occur until the late 1960's and that primarily in Europe. Much pioneering work was sponsored by the Institute National des Industries Extractive (INIEX) in Belgium and by the National Coal Board (NCB) in the United Kingdom.<sup>(8-18)</sup> A number of studies have been sponsored by the U.S. Bureau of Mines<sup>(19-22)</sup> and an experimental installation was made in Bethlehem Steel Corporation's Grace Mine, near Morgantown Pennsylvania.<sup>(22)</sup> To date, however, the use of leaky feeder systems in US mines is still rather limited.

## **2.2.2 Cable Types and Characteristics**

### **1. Twin Lead**

Following the work of Monk and Winbigler (op.cit.) a number of twin-lead systems were installed for the purposes of providing tunnel communications. A popular feeder for this purpose was the now obsolete 200 ohm RG-86/U. The original specification covering RG-86/U (Mil C-17/41, issued 1955) was deleted in 1969. It remained available from surplus stocks for some time afterward, but these stocks are now virtually exhausted. However, some still remains in use. Advantages noted were its relative low cost and ease of installation. However, tests by the National Coal Board in the very wet Longannet mine in Scotland showed twin lead cable to suffer catastrophically from contamination by moisture and grime, and to be very sensitive to proximity to walls and other cables. An open braided cable was eventually adapted for the Longannet mine and remains the NCB preference for coal mining use.<sup>(18)</sup>

### **2. Open Braided Cables**

Open braided cables are similar in construction to standard flexible coaxial cables with the exception that the outer conductor braid is loosely woven to permit a substantial leakage field outside the cable. Although preferred in the United Kingdom by the NCB there is no known use of this type of cable in US underground mines. A similar cable is sold by Locrad, Inc. in the United States for use at standard AM broadcast band frequencies for highway advisory radio systems, Locrad cable is illustrated in Figure 2.1A.

### **3. "Radiax" Slotted Coaxial Cable**

Illustrated in Figure 2.1B, Radiax is manufactured and sold by the Andrew Corporation. It is similar in construction to the Andrew "Helix" cable but with a series of holes or slots milled into the corrugated solid copper outer conductor. It is available in both 1/2 and 7/8 inch diameter sizes. To date, it is the only leaky feeder known to be in use in US mines.

#### **4. “Tennaflex” Continuous Slot Coaxial Cable**

Illustrated in Figure 2.1C, Tennaflex is manufactured and sold by Cablewave Systems, Inc. It employs a continuous slot in the solid copper outer conductor running the length of the cable. Although the manufacturer reports its use in train tunnels and for paging systems in tall buildings, no attempt has been made to use it in underground mines.

#### **5. Halstead Spiral Ribbon Cable**

Illustrated in Figure 2.1D, this cable was developed for use at standard AM broadcast frequencies. It is a patented cable manufactured by Comm/Scope and marketed by Halstead Communications, Inc. It is actually a “triaxial” cable consisting of a thin copper ribbon spiralled around the outside of the outer conductor of a coaxial cable. The leaky feeder pair is formed between the spiral ribbon and the grounded sheath, or outer conductor of the coax. The inner conductor plays no role in the leaky feeder operation. However, it could conceivably serve an auxiliary purpose, such as transmitting a radio frequency carrier, audio, or power for in-line repeaters. The supplier reports no use of the cable to date in the VHF and UHF bands normally used for mobile radio communications.

#### **6. Mode Conversion Systems**

A system that permits the use of ordinary coaxial cable in the INIEX/Delogne system recommended by INIEX and used in Belgian mines.<sup>(4)</sup> The principles of the system are described in US patent 3,829,767 issued in 1974 to Paul Delogne. Discontinuities are introduced periodically into the coaxial cable which convert radio frequency energy from a nonradiating “bifilar” mode to a “mono-filar” mode in which the fields travel along the exterior of the cable between the outer conductor and the walls of the tunnels. The discontinuities are created by the insertion of specially designed mode converters, or “radiating devices” in the cable at the desired intervals. The mode converter design is adjusted to provide the exact degree of discontinuity required.

#### **7. Alternating Standard and Leaky Feeder Coax**

Yet another technique proposed by Delogne and covered by US patent 4,152,648 issued in May 1979 is the alternation of sections of standard nonradiating coaxial cable with lengths of leaky feeder cable. The length of the leaky feeder sections is determined from:

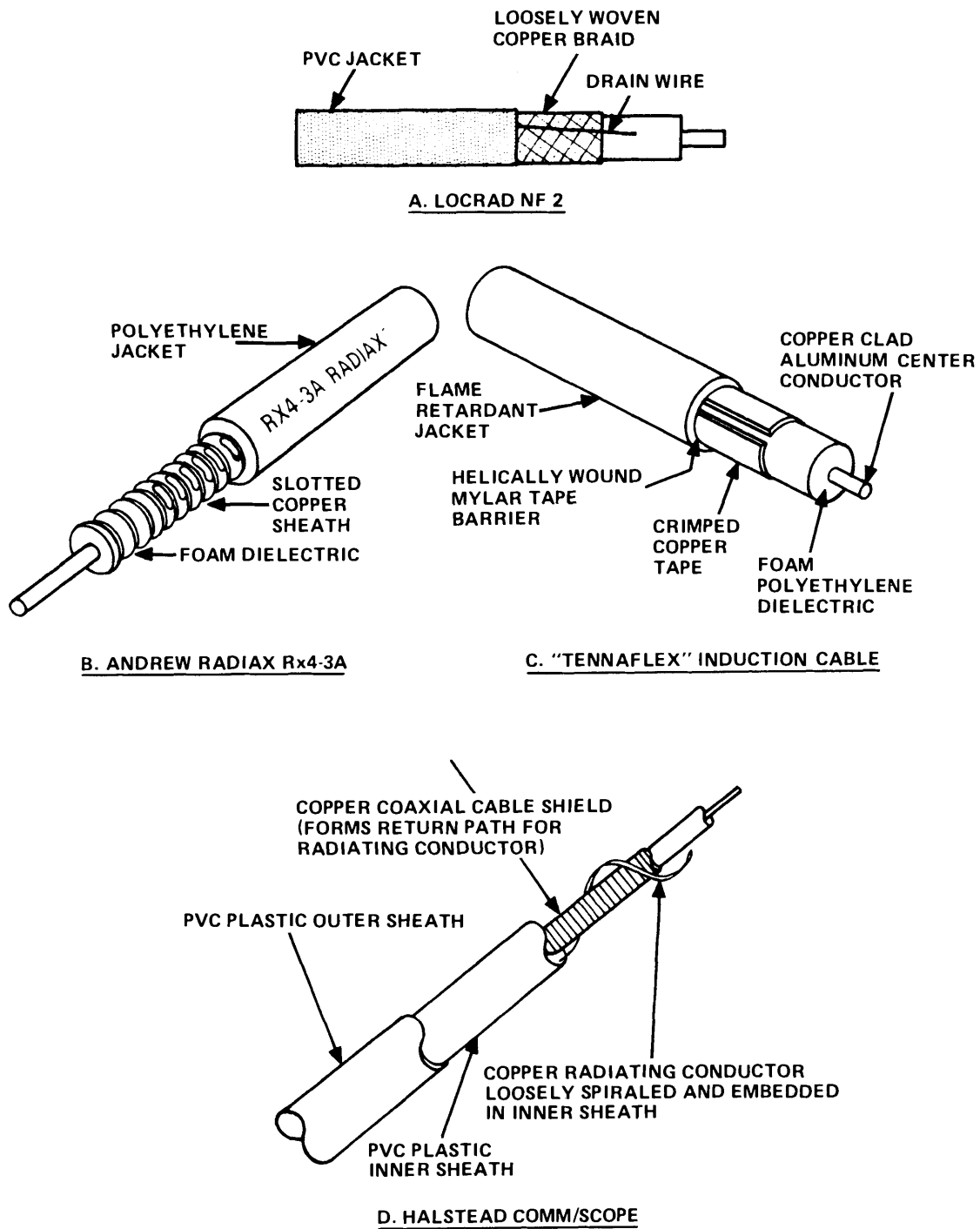


Figure 2.1. Commercially Available Cable Antenna Types.

$$L = \lambda/2 (\sqrt{\epsilon - 1})$$

where

$\lambda$  = free space wavelength

$\epsilon$  = dielectric constant of the insulating material.

The leaky feeder section here performs as a directional mode converter exciting a monofilar mode in the downstream direction which continues to follow along the nonradiating section. Radiation, being directional, is more efficient than that obtainable with straight leaky feeder cable. Also, the total cost should be less to the extent that nonradiating cable is less expensive than most leaky feeder cables.

### 2.2.3 Cost Comparisons of Cables

Cable and cable installation costs are necessarily a major part of the total price of any leaky feeder system installation. The least expensive of the various cable types examined was the RG-86/U twin lead, used in one of the mines surveyed during this project. It could be purchased in 1975 for about \$0.10 per foot. However, attempts to locate a source in 1980 has proved fruitless. This type cable is obsolete and apparently is no longer kept in stock. All leaky feeder cable known to be in use in US mines is either Andrew Radiax type RX4-1 (1/2 inch diameter) or type RX5-1 (7/8 inch diameter). 1980 prices for quantities between 5,000 and 25,000 feet were quoted at \$1.66/foot and \$3.32/foot respectively. Prices are higher for quantities less than 5,000 feet, and less for quantities exceeding 25,000 feet. The larger size has the advantage of lower radio frequency attenuation, allowing the number of base/repeater stations to be reduced by approximately one-half. For example, to equip 10,000 feet of tunnel with the 1/2 inch diameter cable would require at least two base/repeater stations. A similar installation with the larger size should require only one. If the cost of a repeater station is estimated at \$5,000, plus another \$5,000 to maintain that station for 10 years, the two examples may be compared as follows:

<b>a.</b>	<b>Example 1</b>	
	10,000 feet of RX4-1	\$16,600
	2 repeater stations at \$5,000	10,000
	Maintenance for 10 years	10,000
	<b>Total</b>	<u>\$36,600</u>



<b>b. Example 2</b>	
10,000 feet of RX5-1	\$33,200
1 repeater station at \$5,000	5,000
Maintenance for 10 years	5,000
Total	<u>\$43,200</u>

These figures do not include installation costs, which are likely to be somewhat higher for Example 2 because of the greater difficulty in handling the larger size cable. In general, the smaller size cable is likely to prove more cost effective in most situations.

There are other leaky feeder cables available in the United States (Section 2.2.2) which have possible applications in underground mines, but none is yet known to have been tested in a commercial mine installation. One is Cablewave Systems, Inc. "Tenna/Flex" which is designed for applications similar to Andrew Radiax and has been used in train tunnels. Cost is competitive with Radiax. Other cables referred to in Section 2.2.2 include Locrad and Halstead. Based on simultaneous purchases of 6,000 foot lengths of Locrad NF-2, Halstead, and Andrew RX4-3A in late 1978, the cost of Locrad and Halstead were respectively 57 percent and 61 percent of the cost of the Andrew cable. Further investigation of such alternatives could possibly result in reduced cable costs.

### 2.3 Single Repeater Systems

The operation of a leaky feeder single repeater system is illustrated in Figure 2.2. The repeater base station transceiver in the center is connected to a length of cable through a power splitter. Typically, the cable will consist of about 5,000 feet of 1/2 inch Radiax. It is assumed in the figure that the operator of the mobile Transceiver A is speaking to the operator of the mobile Transceiver B. Transceiver A transmits on frequency F1. This is picked up by the cable and transmitted to the repeater receiver. The received audio keys and modulates the repeater transmitter, which transmits on F2. The retransmitted signal propagates along the cable (in both directions from the repeater) and can be received by any receiver tuned to F2 and in the proximity of the cables. In the illustration, it is heard by the operator of mobile Transceiver B. If the operator of Transceiver B wishes to reply to Transceiver A, the process is reversed. Transceiver A transmits on F1 which is received and repeated on F2 by the repeater, which is received by Transceiver A. Not shown is a dispatcher's control console which can be at the repeater site or at some distance away from the site with wire line interconnection. The dispatcher, by direct control of the repeater transmitter and receiver, can monitor or communicate with all mobile transceivers using the system. The system also allows all mobile and portable units capable of receiving F2 and within the area of coverage to monitor both sides of all conversations conducted on the system.

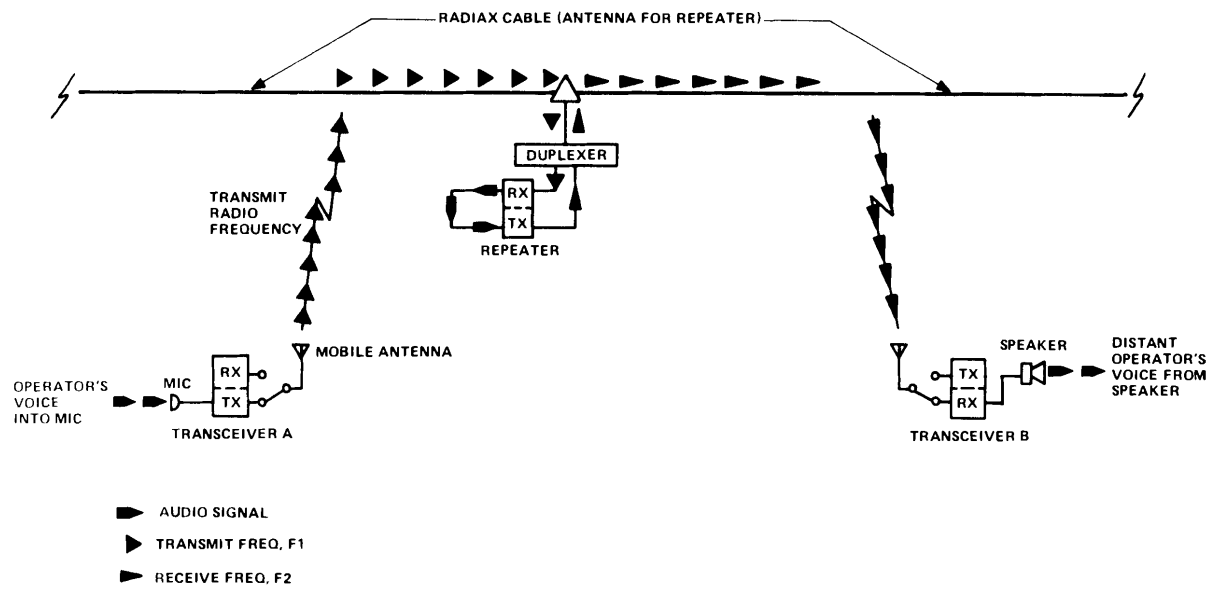


Figure 2.2. Single Repeater System.

## 2.4 Multiple Repeater System

A single repeater system as illustrated in Figure 2.2 might cover up to 5,000 feet of tunnel with 1/2 inch Radiax, or perhaps up to 10,000 feet with 7/8 inch Radiax. When more coverage is required, practice in North America has been to use multiple repeater systems connected for simultaneous operation. A typical system of three repeaters is illustrated in Figure 2.3. The repeat function is the same except in the way the repeater audio is handled. Any mobile unit attempting to transmit may be received by any one, or more than one of the repeater stations. Therefore, the received audio from all repeaters is returned to an audio comparator or "voting" unit which selects the best signal (i.e., the best signal-to-noise ratio). The selected audio is then applied to the common transmit line to simultaneously key and modulate all repeater transmitters. Any properly equipped mobile unit anywhere within range of any of the multiple repeaters can receive the transmission and reply to it. Further, by means of the cross patch at the console, the entire system can be connected to any other system either on the surface or in another area of the mine.

## 2.5 Alternative Leaky Feeder Configurations

The use of single and multiple repeater systems as described in the preceding sections are extensions to underground mines of well known techniques long used in surface radio systems. The radio equipment used is identical to that used on the surface and is therefore readily available and familiar to installation and maintenance personnel. In US practice, a standard base station transmitter is limited to about 5,000 feet of 1/2 inch diameter leaky feeder cable. An extension beyond this requires additional base stations. However, practice in other countries, particularly in the United Kingdom, has shown that there are a number of advantages to be achieved by other use of small line-powered, in-line cable repeaters. The technique is similar to that used in cable television technology. The principal advantages are:

- a. Transmitter powers can be greatly reduced
- b. Much greater lengths of cable can be driven from a single base station
- c. Signal levels are more uniform over the entire system.

Work by the UK National Coal Board (NCB) indicates that a repeater spacing of 500 m (1640 feet) in the 68-88 MHz band allows transmitter power to be reduced by a factor of 1,000 or more (from watts to milliwatts) as compared to the use of multiple base stations. Even the powers of mobile units can be reduced by a factor between 10 and 100. The total length of a repeatered cable as in cable television, is limited only by the accumulation of noise, which increases by 3 dB each time the number of repeaters is doubled.

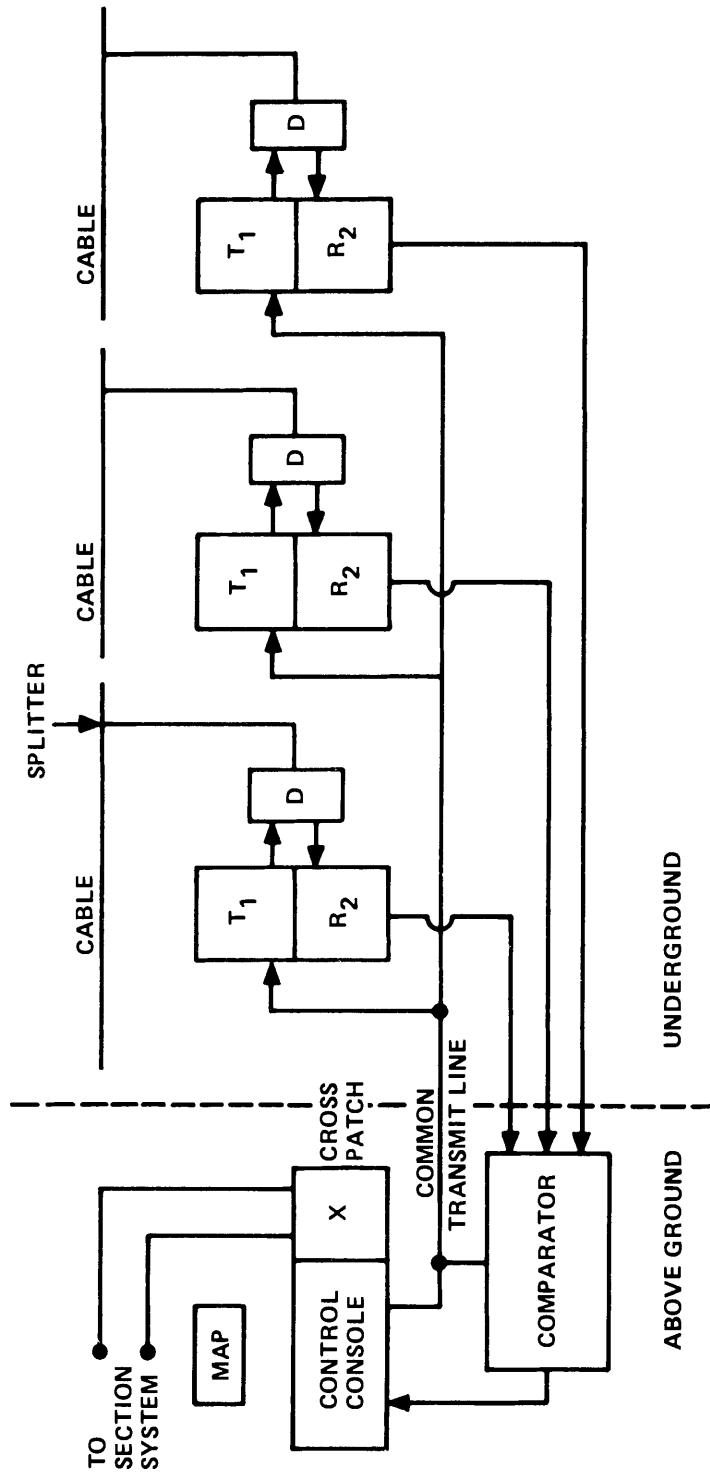


Figure 2.3. Typical Multiple Repeater Systems.

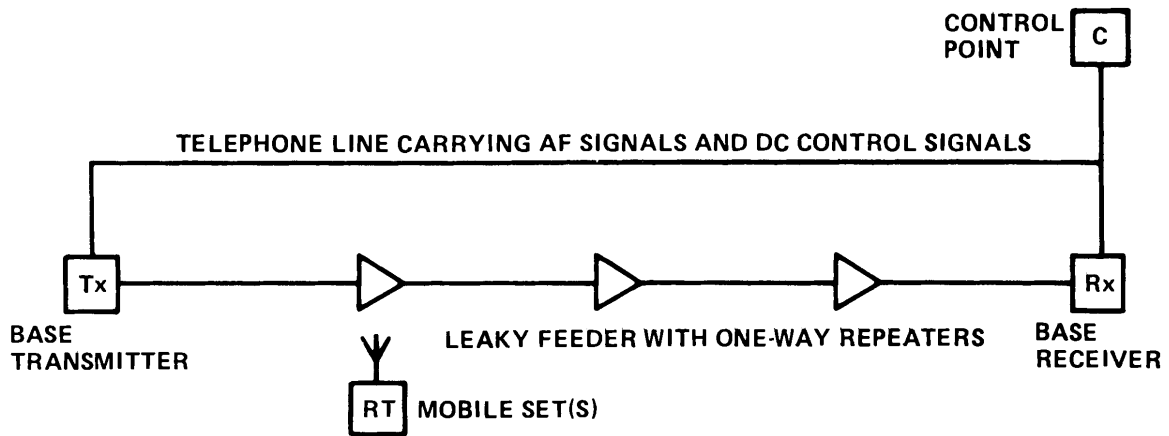
The simplest system using in-line repeaters is the “daisy chain,” illustrated in Figure 2.4A. The transmitter and receiver are located at the opposite ends of the cable. A particular requirement of this system is an audio line (or other means) for returning the received signal to the control point. Nonetheless, over 70 coal mines in the UK are reportedly equipped with this type of system.

Another disadvantage of the daisy chain is the difficulty of adding branches and spurs to the basic system. This problem can be overcome by the use of a double daisy chain as shown in Figure 2.4B. However, this system has its own disadvantage, which is the doubling of leaky feeder cable cost. The most desirable solution is the use of a single cable with bidirectional repeaters – already a well established technology in cable television systems. With good linear amplifier design, a number of frequencies can be transmitted simultaneously in both directions. As shown in Figure 2.4C, this is achieved by splitting the frequency band into upper and lower parts. One part is used for “up-stream” transmission, and the other for “down-stream,” or transmission in the opposite direction. At the repeater, the up-stream and down-stream input signals are separated by filters, amplified, and transmitted on in their original directions of travel.

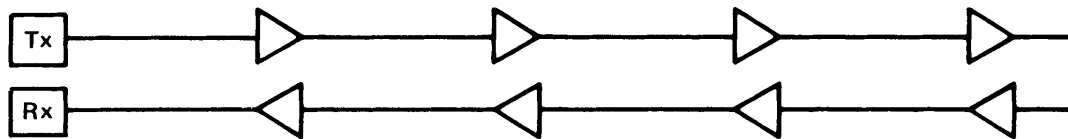
There was not at the time of this study any US underground mine known to be using in-line repeaters in a leaky feeder communications system. However, it was learned that such a system is under development by Motorola Communications, Inc., and is scheduled for installation in an Inland Steel mine at Sesser, Illinois. The initial system will employ 50 to 70 thousand feet of Andrew Radiax cable. It will carry five channels as follows:

1. 2 base-mobile communications channels
2. 1 data channel
3. 1 mobile-to-mobile talking channel
4. 1 alarm channel.

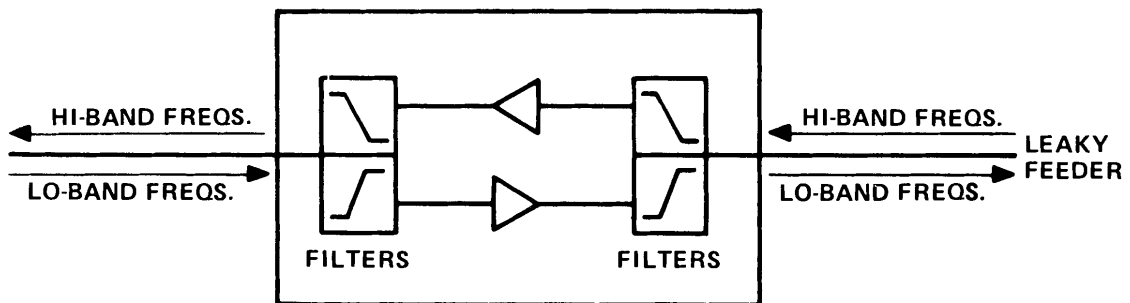
It is planned that this system will be in operation by late 1980.



A. SIMPLE DAISY-CHAIN SYSTEM



B. DOUBLE DAISY-CHAIN



C. BI DIRECTIONAL AMPLIFIER

Figure 2.4. Daisy Chain Systems.

### **3.0 SURVEY FINDINGS**

#### **3.1 Description of the Survey**

This project called for the collection of data, its evaluation, the drawing of conclusions and the making of recommendations concerning the usefulness and the degree to which leaky feeder radio systems have been implemented in underground mines of North America. Many studies of leaky feeder cables have resulted in numerous recommendations for their use in mines and a number of such systems have been installed and are currently in use, some for a number of years. In view of this, it was felt that there should be a body of experience available which may, or may not support earlier speculation on the usefulness of leaky feeders in a mining environment.

An exacting questionnaire was developed and a two-man survey team was assembled to personally visit selected mines known to employ some form of leaky feeder radio system. The two team members were selected with backgrounds specifically oriented toward the needs of the study. One team member was a communications engineer with experience in two-way radio systems. The second member of the team had experience in mining, mine safety and human factors relative to mining operations. During these visits mine personnel responsible for the maintenance and/or management of the radio system were interviewed. The objective of the interviews was to collect the information necessary to characterize experience with this type of system (i.e., typical advantages claimed, typical costs, typical complaints, etc.).

The following sections contain the data collected from seven mines. Altogether six mining companies controlling ten leaky feeder equipped mines were interviewed. These, with one other company that declined to be interviewed, represent all the companies in North America known to have leaky feeder systems in place and operating. At least two others had used leaky feeders earlier but had since discontinued its use. One of these had used a passive system (i.e., a leaky feeder cable only – without a base or repeater) to provide portable-to-portable communications from end to end of a longwall coal mining operation. It was discontinued when the longwall was shortened to less than 200 feet, making direct portable-to-portable contact possible without the cable. The other was a more conventional repeater system, but was reportedly discontinued because the miners rebelled against its use.

The production figures which appear in the following sections were approximated from public records for the latter half of 1978 and early 1979.

## **3.2 Mine Survey Findings**

### **3.2.1 Survey Data – Mine A**

#### **(1) Description of Mine**

The mine is located in the Rocky Mountain area of the United States. It produces approximately 4 million tons of molybdenum disulfide ore per year (with an estimated value of \$9.8 million), using the block and cave method of mining and electric locomotive ore haulage. The mine has 15 miles of railroad, most of which runs underground, connecting the loading drifts to the processing plant. The mine uses a 13,600 VAC primary power distribution system. This is rectified to produce 600 VDC and 1400 VDC to power the locomotives. DC locomotive motors are shielded to reduce RF interference. Mercury vapor stationary mine lighting is utilized.

#### **(2) Total Communications System**

The mine employs several varieties of communications systems both above ground and below ground. Two-way radio is employed on the surface for the coordination and control of surface operations and the dispatching of maintenance crews while on the surface. A microwave system is used to interconnect the mine site with the processing site on the other side of the mountain. The mine also maintains its own PBX telephone switchboard and rotary dial telephone system for both surface and some underground communications.

Below the surface a multichannel Gai-Tronics phone system is used throughout most of the mine. The leaky feeder radio system is employed on the haulage level only. The hard wired Gai-Tronics pager phone system is used only for emergency communications, and occasionally by repairmen to avoid loading the radio system when long conversations are needed.

#### **(3) Description of the Leaky Feeder Communication System**

The leaky feeder radio system, operating in the VHF (150 MHz) range, is utilized in the management, operation and maintenance of the underground railroad ore haulage system. The system layout is shown in Figure 3.1. The system consists of three subsystems. The first, a single repeater subsystem, services the haulage loading area. The second, a five repeater subsystem, services the main tunnel to the portal. The third subsystem services the haulage locomotives on the surface from the portal along a 4.0-mile surface rail system to the processing mill. All three subsystems are interconnected via audio cable and a receiver voting comparator.



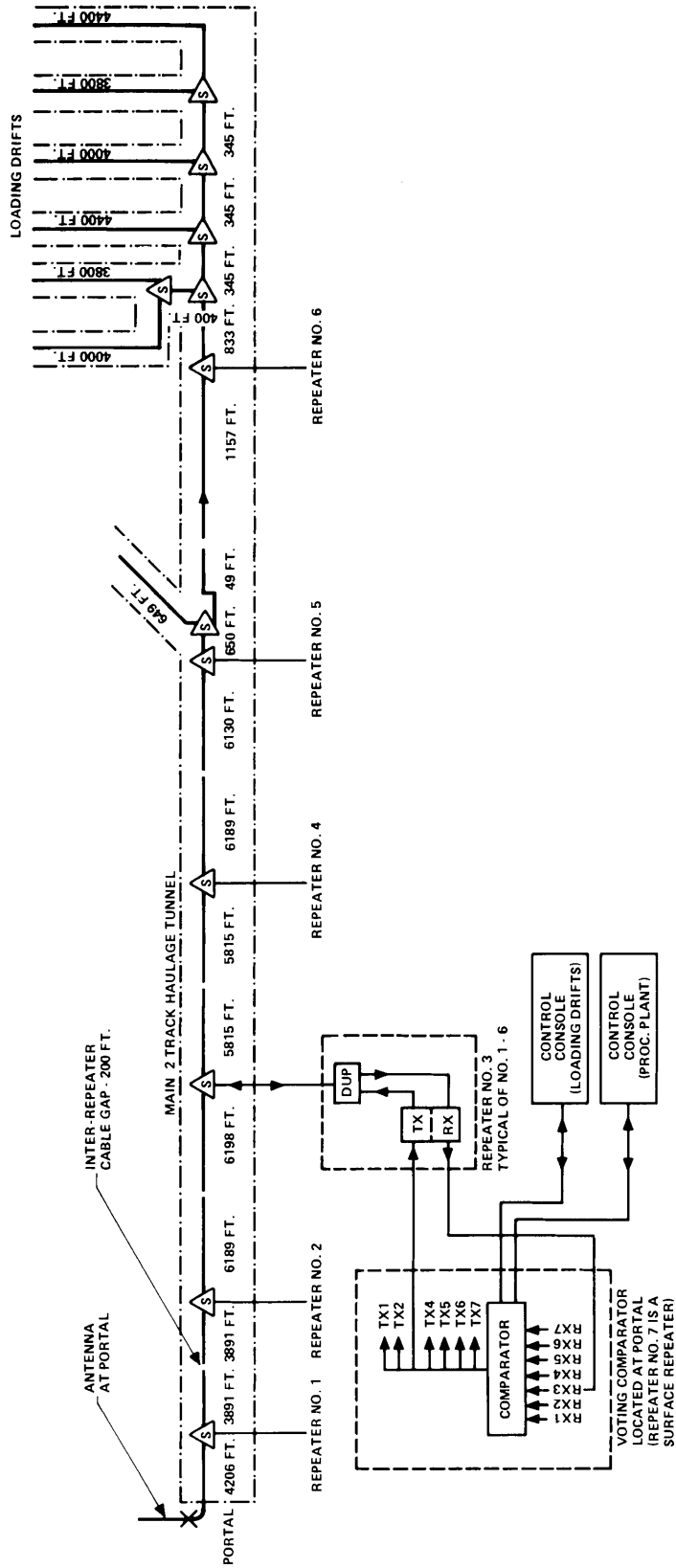


Figure 3.1. System Layout, Mine A.

A dispatch control center (DCC) is located at both ends of the system, one near the loading drifts and one at the processing plant (Figure 3.2). The entire system operates on a single VHF transmit/receive frequency pair, such that any mobile or portable unit anywhere within the coverage area can conduct two-way communications with any other mobile or portable unit, or with either of the two DCC's.

The radio system is used by all employees engaged in haulage activities, including maintenance personnel. The primary purpose of the system is to control the loading and operation of an 8 to 10 train electric haulage system. Repair functions are also coordinated by radio. Maintenance and rescue are secondary functions to control of haulage, and are provided only on an as-needed basis. Two dispatchers coordinate all operations using the radio system. A typical UHF repeater is shown in Figure 3.3. The antenna, control head and mobile radio used on the trains are shown respectively in Figures 3.4, 3.5 and 3.6.

Haulage control communications average 1 call per minute. The system is used for other functions only as needed. Peak radio useage corresponds only to haulage system failures. This includes train failures, derailings, power failures, etc.

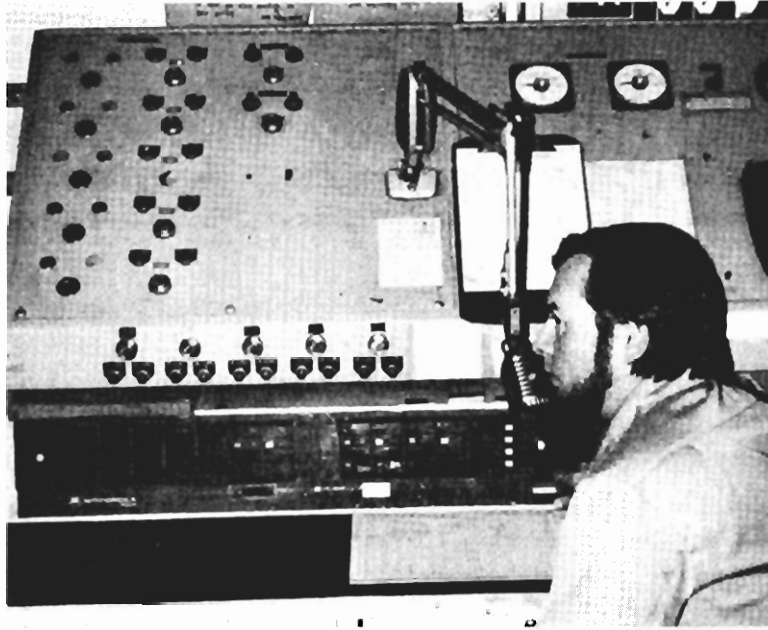
It should be mentioned that the mine has had at least two haulage train runaway incidents. The management feels that the presence of the radios greatly reduces the possibility of serious injury in such cases.

#### **(4) Equipment Description**

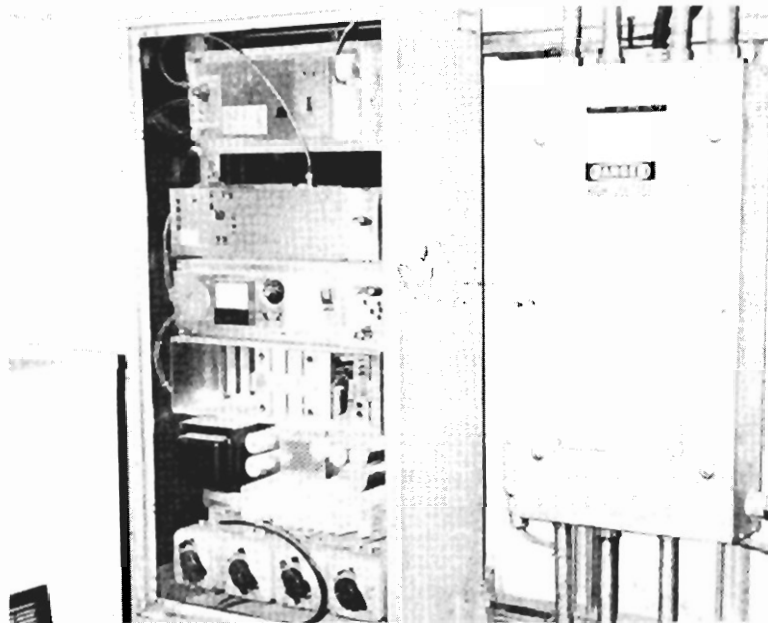
All radio equipment was furnished and installed by Motorola. Currently used inside the mine are:

- 6 Micor VHF repeaters (90 watts)
- 50 HT 220 portables with extended speaker/mikes (5 watts)
- 37 Micor railroad radios (45 watts)

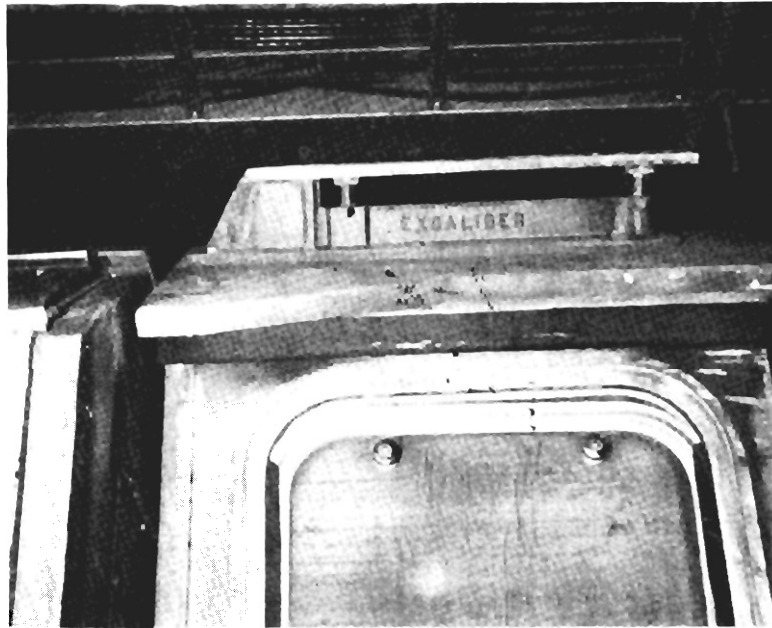
Most of the 15 to 18 miles of cable is 7/8-inch Andrew RX5-1 Radiax. The only exception is about 1200 feet of 1/2-inch Radiax between haulageway and loading drifts. In the haulage tunnel, the Radiax cable is laid in a steel cable tray from which the 1400 VDC trolley (Figure 3.7) is suspended. Ends of the Radiax cable are not terminated, but left open-circuited. This appears to create no problem because RF fields are sufficiently high inside the tunnel even at the standing-wave minima.



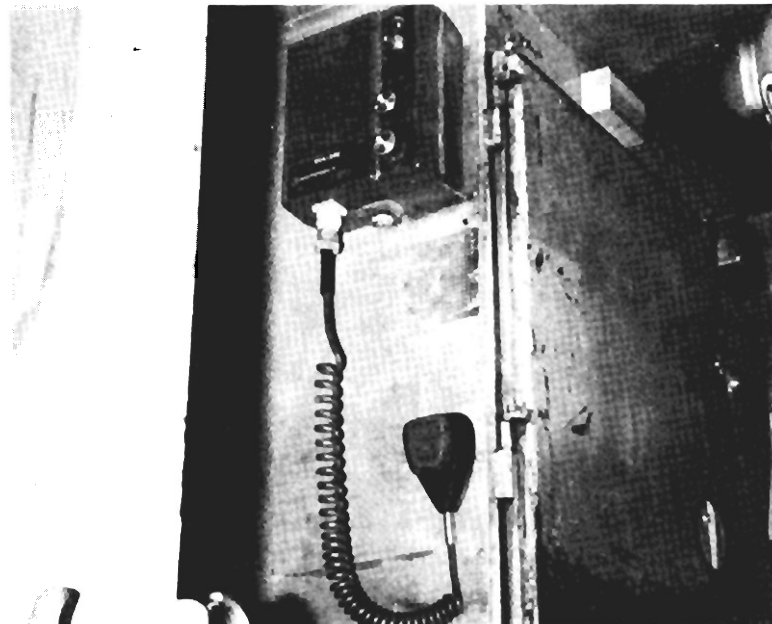
**Figure 3.2. Primary Haulage Dispatch Console on the Haulage Level at the Loading Drifts.**



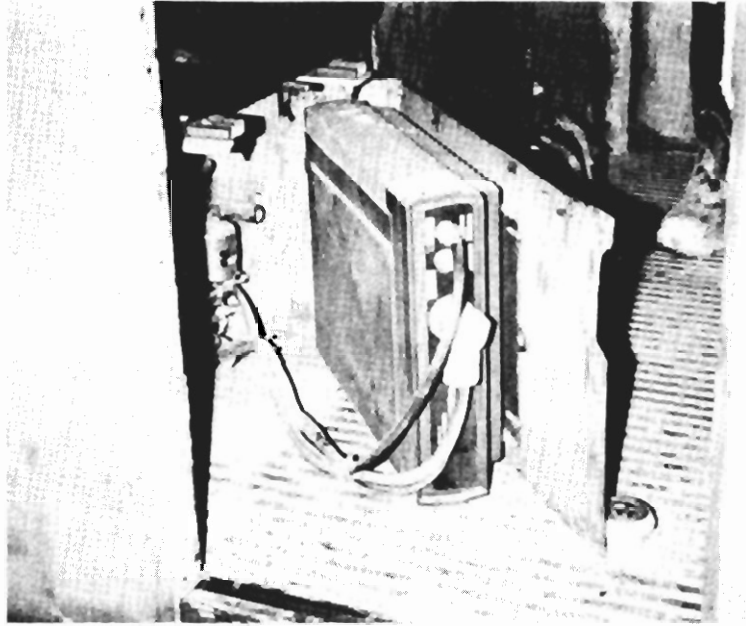
**Figure 3.3. UHF Repeater at the Haulage Dispatch Center.**



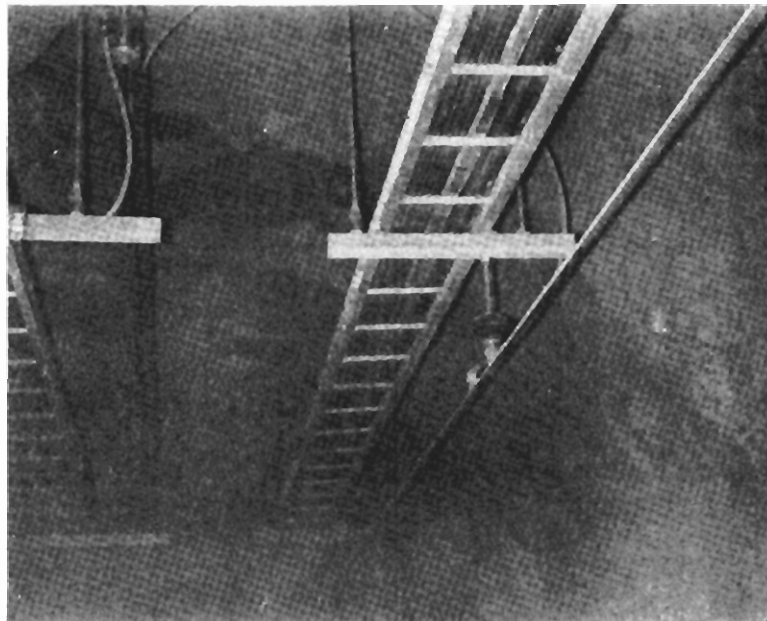
**Figure 3.4 Railroad Style UHF Antenna Mounted on Haulage Motor.**



**Figure 3.5. Railroad Style UHF Mobile Radio Control Head in Cab of Haulage Motor.**



**Figure 3.6. Railroad Style UHF Mobile Radio Mounted under Motor Operator's Seat.**



**Figure 3.7. Cable Trays Carrying all Cables, Including Radiax Mounted in Roof on the Main Haulage Tunnel. Tray also Supports Trolley Power System.**

A 5-pair shielded telephone cable is used for audio interconnection of the system (repeaters, voting comparator and DCC's). This cable is laid in the same cable tray with the Radiax and other cables.

#### **(5) Procurement Background**

Procurement was initiated by the mine through inquiries made to several manufacturers. Only Motorola responded. Contract was a basic "furnish and install" agreement which included no detailed technical specifications. The system was installed between March 1975 and May 1976. Initial performance of the system was well below expectations of mine personnel primarily because of noise (hum) in the audio and prolonged outages due to equipment failures which were aggravated by the long travel time of the service contractor. Considerable work has since been performed by the mine's in-house maintenance staff thereby eliminating most of these start-up problems.

#### **(6) RFI Problems**

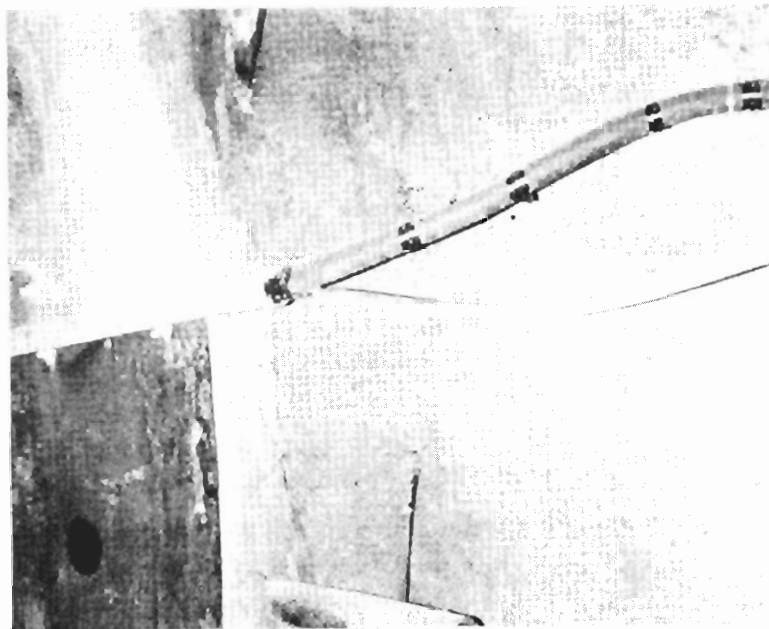
In the initial installation an annoying 120-Hz rectifier hum was picked up by the audio lines running parallel to the 1400 VDC trolley line. This has subsequently been reduced to an acceptable level by the addition of line driver amplifiers. These increased the audio levels with respect to the hum pickup, resulting in a higher signal-to-hum ratio. No other interference problems were reported. All re-engineering and repair connected with the elimination of the interference was performed by the in-house maintenance staff.

#### **(7) Problems of the Mine Environment**

Radiax damage frequently occurs in the loading area by the blasting of excess ore from the top of overloaded rail cars (Figure 3.8). The blasting is necessary to ensure the minimum required clearance of 4 inches between the top of the loaded ore car and the trolley power system. The blasting causes the Radiax to be peppered with small high speed projectiles which either completely destroy a section of cable or penetrate enough to cause the outer conductor to collapse against the inner conductor causing either a short circuit or dramatic change in impedance characteristics. As cable is replaced within the loading area, it is being placed inside fabric reinforced air hose and then reinstalled (Figure 3.9). This operation is performed by inserting the Radiax in sections of used hose and reinstalling in the drifts. It is assumed that the lengths of both fabric reinforced hose and the Radiax must be kept to a manageable length. This has proven effective in reducing damage caused by blasting.



**Figure 3.8. Blasting Damage Done to Unprotected Radiax in Loading Drifts.**



**Figure 3.9. New Method of Protecting Radiax in Blasting Areas, Installed within Fabric Reinforced Hose.**

Due to high humidity, dust and mud, all radio duplexers have had to be sealed to prevent continued damage to the cavity wiper arm. This was accomplished by covering all openings in the duplexer housing with plastic electrical tape.

Portables have suffered a fair amount of damage due to simple abuse. Three have been totally destroyed within a 3-year period. Two of these were dropped into the ore crusher and one was retrieved from a sump pond after 6 months. Other radios suffer from cracked cases, damaged crystal lattice filters, etc., from either dropping or from misuse as a "hammer." A small number have suffered accidental water damage.

#### **(8) Current Level of Performance**

The system serves the mine communications needs for the haulage system very well. There is continuous coverage to the trains and to 5-watt portables (with helical antennas) throughout the haulageway, the loading drifts, and cross cuts between loading drifts.

#### **(9) Maintenance**

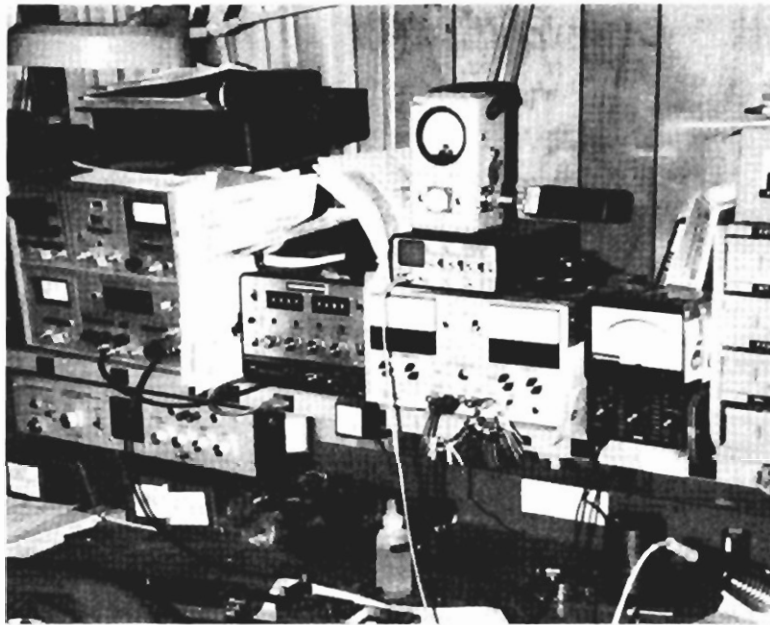
During the first year of operation all maintenance was contracted to an outside service agency. Subsequent maintenance has been performed by an in-house staff of one supervisor and six FCC licensed technicians. This staff also maintains the mine's telephone, pager phone, and other (surface) radio systems. It was observed that the quality and professionalism of the maintenance is outstanding. The shop is very well equipped with a more than adequate stock of spare parts and state-of-the-art test equipment. It is felt that because there are experienced radio personnel in the management positions responsible for radio service that the maintenance facility is staffed and equipped adequately. A view of the maintenance area is shown in Figure 3.10.

Preventive maintenance and performance testing is performed every 6 months or as a part of normal servicing. Repeaters are cleaned every 30 days.

#### **(10) Costs**

The initial leaky feeder communications system costs the mine approximately \$800,000. Annual maintenance was estimated by the electrical superintendent to be \$100,000 for all of the mine's communication systems including parts and labor. It was estimated that this amount breaks down into \$20,000 for the leaky feeder system, \$20,000 for other radio systems, and \$60,000 for the telephone system. In view of the seven man shop, the \$100,000 estimate appears to be low. It appears more probable that the annual maintenance figure exceeds \$140,000 with perhaps the same 20-20-60 percent breakdown.





**Figure 3.10. In-house Radio Maintenance Work Area.**

**(11) Benefits**

This system was installed new with the mine. Because no comparison can be made, management can only state that production would be limited to 1/5 the present level because of a two train operating limit. MSHA now approves the 10 train ore haulage system because of the continuous communications system.

Safety has been improved by the radio as it provides immediate communication between trains. This allows an operator to warn others of haulage dangers, stopped trains or tunnel hazards. This system also allows rescue workers complete communications while on an accident scene, not the limited telephone communications common in most mines.

**(12) Attitudes of Miners and Mine Operators**

The leaky feeder system meets the expectations of management. Simply stated, these expectations were, and still are, to provide dependable, instant communications within the tunnel haulage system. It did not when it was originally installed because of reliability problems, limited coverage and poor maintenance. When the in-house maintenance shop was added the system was quickly brought up to a reasonable level of performance. Management now likes the system and supports it. They understand that without it, large production losses would occur.

Management also feels most miners like the system because without it most would not have their jobs. Most miners feel the radio is part of their job and more than likely abuse the equipment only because of their lack of knowledge of proper operating procedures. The only complaint of miners themselves is with failed radios.

**(13) Plans for Expansion**

Management expects to expand the system as haulage expands. Consideration has been given to the use of radios on the production levels.

**(14) Management Recommendations to New Purchasers**

Management feels their purchase was correct. This was the first private sector mine in the United States to install such a system, and this was at a time when no "experience" data was available. They wish they had specified more precise performance standards and had more in-house radio experience before the acceptance of the newly installed system.

They feel new purchasers should contact current operators of radio systems to avoid the start-up pitfalls. They also recommend site visits to get a first hand feel for operating systems. They further recommend installing cable protection in areas where rock blasting occurs.

### **3.2.2 Survey Data – Mine B**

#### **(1) Description of the Mine**

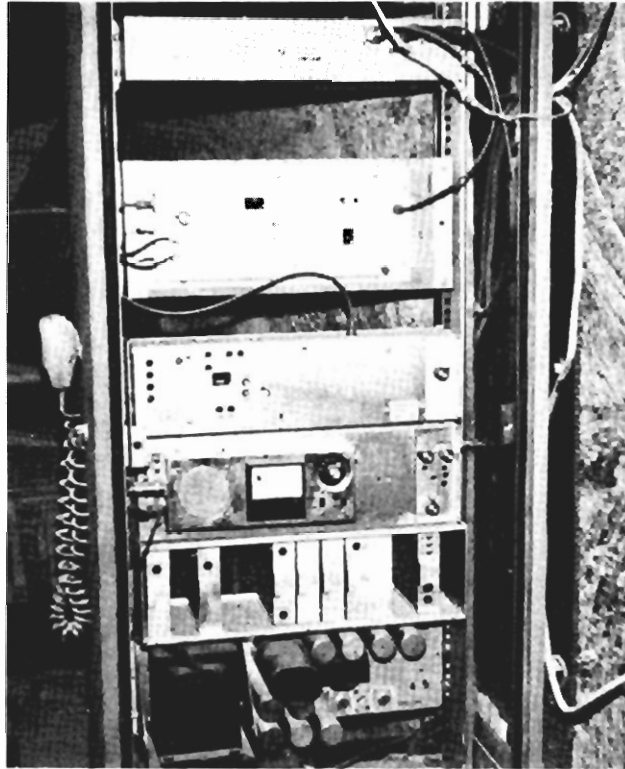
The mine is located in the south central area of Canada. It produces approximately 684 thousand tons of potash annually (at an estimated value of \$11.6 million). A continuous mining method is used employing boring machines and extensible belt ore haulage. Mined material is transported to the surface by the mine hoist. Entries range from 12 to 14 feet in height and 20 feet in width with the limitation being the availability of larger boring machines. The mine employs only AC power with a primary distribution system of 13,600 VAC with reduction to 4,160, 575, 220 and 120 VAC. Primary lighting is cap lamp with some stationary fluorescent lighting.

#### **(2) Total Communications Systems**

The mine uses a small amount of two-way radio on the surface for such things as security, dispatching and so on. The entire mine is equipped with a rotary dial telephone system installed and operated by the local telephone company. Telephone instruments below the surface are the only items replaced by mine personnel. The leaky feeder system is utilized throughout the mine.

#### **(3) Description of the Leaky Feeder Communications System**

The leaky feeder radio system, operating in the VHF (150 MHz) range, is used for general management, operation and maintenance of the mine. The system is currently comprised of five VHF repeaters without a receiver voting comparator. A view of one of the repeaters is shown in Figure 3.11. This system does not utilize radiating coaxial cable, but instead uses RG-86/U (an unshielded 200 ohm impedance twin-lead 'lossy' cable) for the radiating antenna lines. The system covers the primary drift areas leading to and from the major development areas of the mine.



**Figure 3.11. VHF Repeater, Wall Mounted, (Front View).**

The system is used primarily by maintenance staff and mine supervisors to dispatch maintenance personnel where they are needed and to aid in the timely dispatch of parts and other repair equipment. Nearly all transportation vehicles are equipped with mobile radios (Figures 3.12 and 3.13), and at one time, the extensible belt miners were equipped with remote control sets which allowed the operators direct access to the radio system. This has been discontinued primarily due to the noisy environment, but management expressed the opinion that it could be reimplemented at any time deemed necessary.

The radio system augments a dial telephone system installed within the mine which is maintained by the telephone company. The telephone system carries most mine-to-surface communications.

#### **(4) Equipment Description**

All radio equipment was furnished and installed by Motorola. Equipments currently in use within the mine include:

- 5 Micro VHF repeaters (100 watts)
- 27 Mocom 35 mobiles (15 watts)
- 1 Console base station
- 9 Tone remote control desk sets

The antenna system uses 50,000 feet of 200 ohm RG-86/U in 2,000-foot sections. For the purposes of proper impedance matching and maximum power transfer, baluns (impedance matching transformers) are used. A 1:4 balun is used to feed a single twin-lead cable (2,000 feet) from a standard 50-ohm coax connected to the repeater. A 1:2 balun (Figure 3.14) is used to feed a double twin-lead cable (4,000 feet) from the repeater. Figure 3.15 shows the method of mounting the cable to the top of the entrance.

#### **(5) Procurement Background**

Procurement was initiated by the mine in early 1975 through informal inquiries to major radio manufacturers. Motorola was the only responding source. The contract was a basic "furnish and install" agreement which included no detailed technical specification. The system went into operation in April of 1976. The system suffered major problems during initial installation which were finally resolved jointly by the manufacturer's field engineers and the local outside service center.

Figure 3.13. Railroad Style VHF Antenna Mounted on the Hood of a Maintenance Jeep.

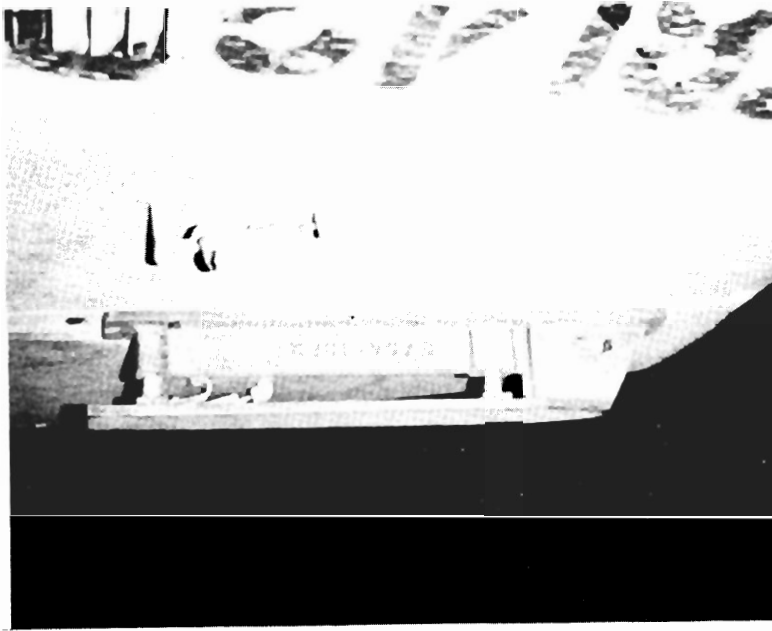
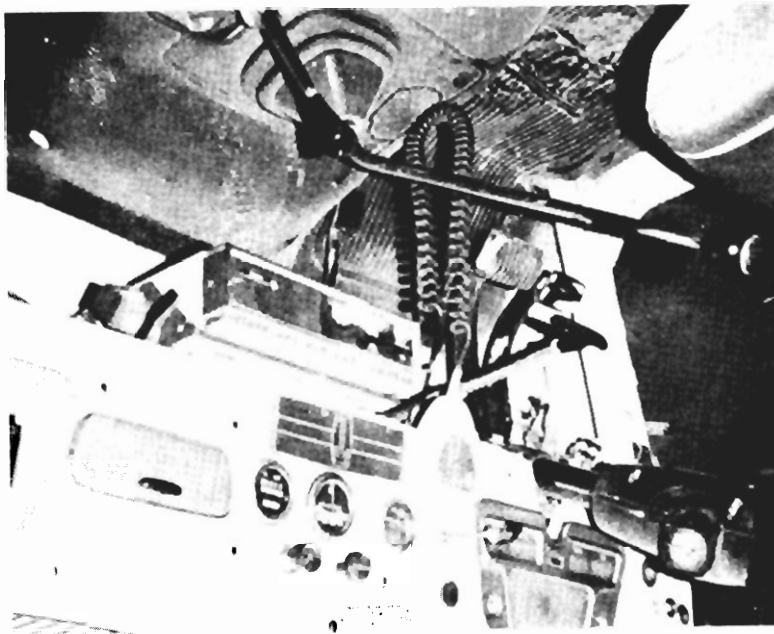
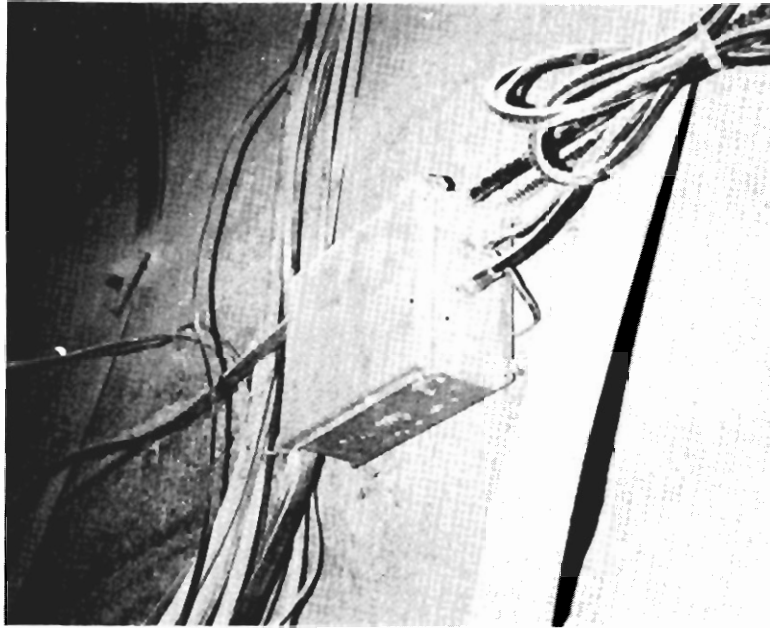
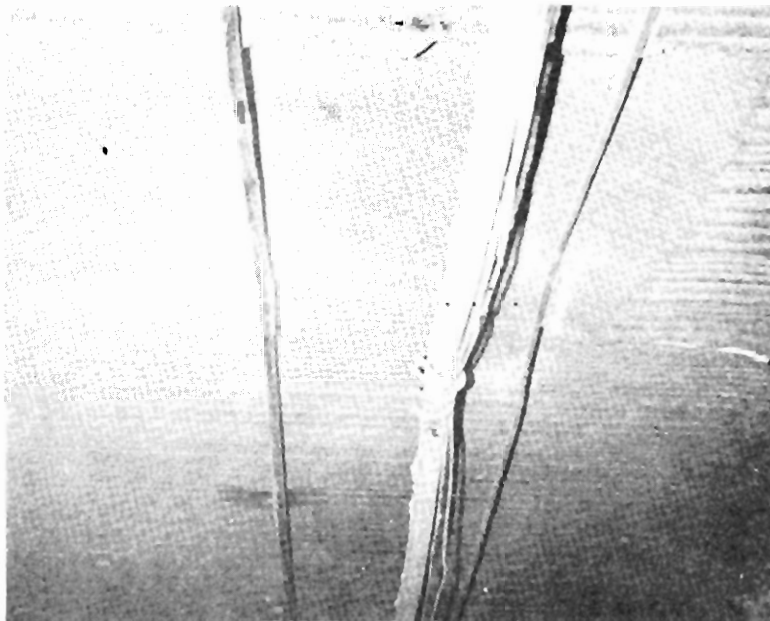


Figure 3.12. VHF Mobile Radio Mounted under the Dash of a Maintenance Jeep.





**Figure 3.14. 1:2 Balun.**



**Figure 3.15. Method of Mounting Twin-lead Antenna Cable to Top of Entrance, Twin-lead is to Right of Large Power Cables.**

## **(6) RFI Problems**

The initial system design called for inter-repeater audio to be transmitted over the RF twin-lead antenna lines thereby negating the necessity for installing additional dedicated lines from repeater to repeater to carry this audio. During preliminary testing the system suffered from significant audio distortion problems which were thought to be caused by this piggyback audio/RF design. It was therefore deleted and separate audio cables were run interconnecting each repeater. Continued testing proved that a circuit modification was necessary within the radio control electronics and that the piggyback design was not at fault after all. The piggyback scheme was not reinstated, however, as the separate audio cables had already been installed.

## **(7) Problems of the Mine Environment**

The system suffers problems because of the fine potash dust emanating from the rotary miners and the belt haulage (Figure 3.16). Subsequent to installation, all repeater stations have been modified to include covers over the convection cooling vents (Figure 3.17). No cabinet fans are used. The accumulation of large amounts of dust reduces the efficiency of the heat sink fins used to cool some electronic components like power supply rectifiers, regulators and RF power amplifiers thus causing premature failure of equipment due to excessive heat damage. Figure 3.18 shows two views of a repeater cabinet cleaned less than 60 days earlier.

Mobile and portable radios suffer normal wear and abuse. The major effect of the dust on the mobiles is the rapid deterioration of the volume and squelch control potentiometers.

## **(8) Current Level of Performance**

The system serves the mine's maintenance communications needs. There is saturation coverage in the primary entrances that are equipped with radio.

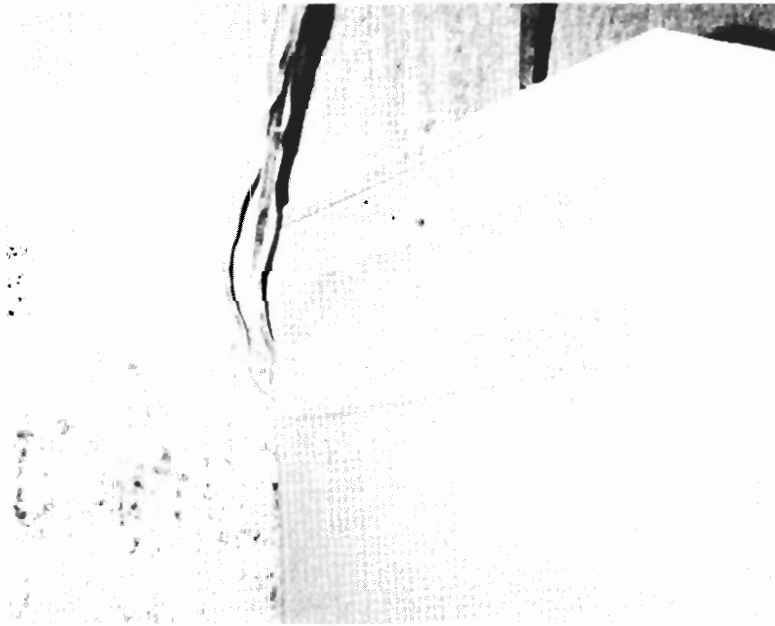
## **(9) Maintenance**

The entire system has been under a maintenance contract from an outside repair firm since installation. Simple repeater relocations, cleaning and wiring repairs are performed by mine electrical personnel; all other maintenance is done by contract personnel. The maintenance contract calls for on-site repair of the repeaters as necessary and preventive maintenance checks to be performed on-site every 6 months. Repair of mobiles and other easily transportable equipment is

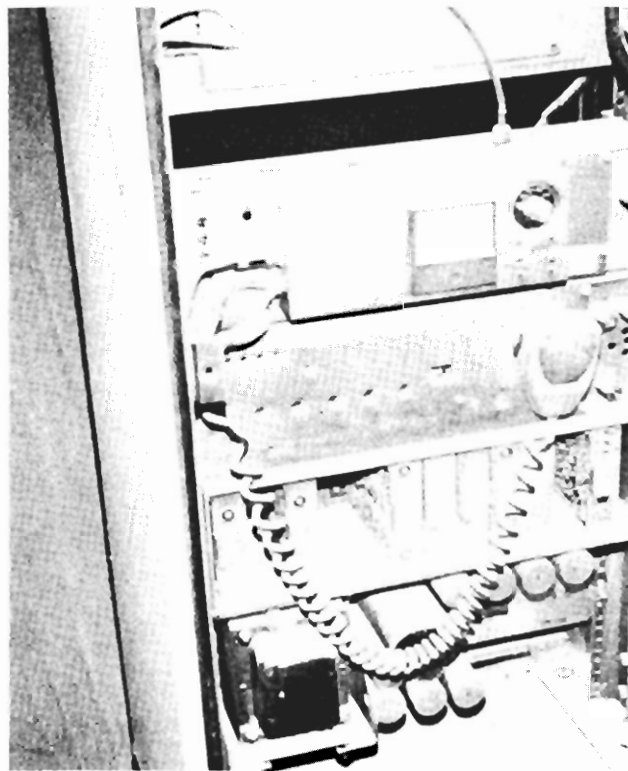
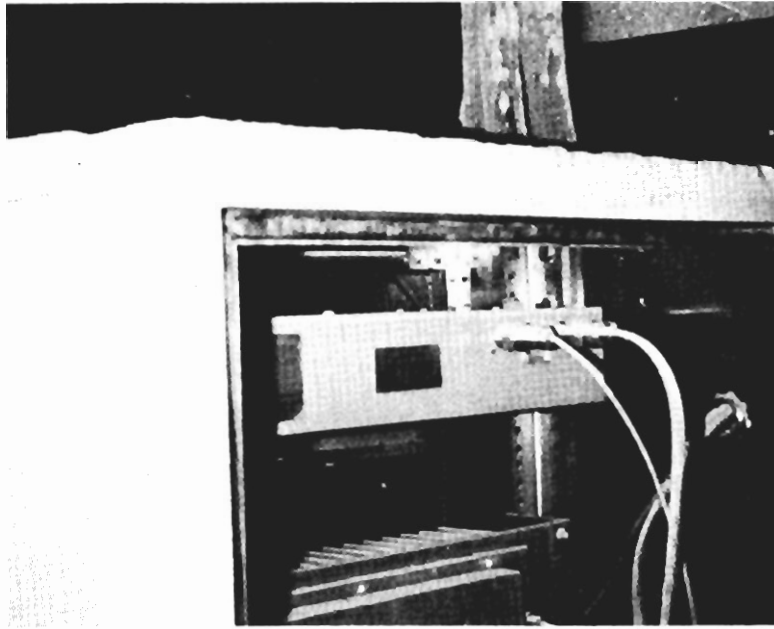




**Figure 3.16. Ore Haulage Belt and Drive Motors.**



**Figure 3.17. VHF Repeater with Convection Cooling Vents Sealed to Protect from Dust.**



**Figure 3.18. Repeater Cabinet Located Adjacent to the Haulage Belt (Radio was Cleaned Less Than 60 Days Earlier)**

accomplished by mine maintenance personnel removing the faulty unit and mailing it to the contract maintenance firm. This leaves vehicles without radio communications for significant periods of time due to long turnaround time. This tends to create the false impression that the entire system suffers abnormal failures and therefore is not reliable. This does not seem to be the case at all, but seems to have affected some miner's acceptance of the system as a viable communication system.

#### **(10) Costs**

The initial communications system cost was approximately \$60,000 for the original equipment which included only 15 mobiles. Since then, additional equipment has been added as necessary. The current cost of contract maintenance is approximately \$600 per month plus travel time and mileage if on-site repairs are necessary. No estimate of mine personnel expense for minor relocations and minor maintenance was available.

#### **(11) Benefits**

Miners and supervisors feel the system increases overall efficiency of the mine's operations. It eliminates the necessity to walk or drive to the nearest mine telephone to request maintenance personnel or to request parts and materials. This type of communications has been especially useful due to the extreme distances between supply depots and working surfaces. It is felt that personal safety is enhanced by the continual presence of the radio in most portions of the mine development area.

#### **(12) Attitudes of Miners and Mine Operators**

As a whole the underground workers appreciate the radio communications system. The major complaint with the system has been reliability of the mobile units. Although the failure rate does not seem excessive, it is apparent that the long delay in repair sometimes gives the impression of a much higher failure rate than actually exists. The workers appreciate the radios ability to eliminate their need to walk to a communications telephone. They also appreciate the ability to have a radio with them at all times, which they feel increases their personal safety. The miners themselves do not feel that the radios are used as a management tool for overseeing their work but have expressed the opinion to management that they often are interrupted while making a repair because a foreman calls them for a second failure. Management also indicated that the men felt the radio made it more difficult for them to "hide", especially when the repair schedule becomes especially busy. Several miners have found that by turning the volume down completely

they can eliminate these interruptions and feel that this is an acceptable solution to their problem. Some individuals also reduce the volume so they could not hear what they consider to be noise on the radio. Both of these procedures effectively disable the radio, thus seriously impairing the communications capability of the system. Management indicated they have instructed miners to not reduce the volume and that this instruction has had limited success.

Management at the mine definitely feels that the radio system is an asset. They feel that the savings are substantial in both production downtime, and the cost to repair an individual item. Given the option, management expressed the opinion that they would like to have a more elaborate system, and some in-house maintenance capability. Overall the communications system is thoroughly accepted at this mine.

### **(13) Plans for Expansion**

Management plans to expand the system as development of the mine continues. The next major expansion is expected in the very near future and will be primarily an extension of the existing twin-lead antenna system. Also under consideration by management is a suggestion by the contract maintenance firm which calls for all new mobiles purchased to be of the Motrac line which are mounted in a watertight enclosure. It is felt that this would reduce failures of mobile radios due to the dusty environment.

### **(14) Management Recommendations to New Purchasers**

This mine had no particular suggestions in this area.

## **3.2.3 Survey Data – Mine C**

### **(1) Description of the Mine**

This relatively new mine is located in the northeastern portion of the United States. It produces approximately 370 thousand tons of coal per year (at an estimated value of \$15.9 million), from eight working surfaces. Mining is by continuous miners and the coal haulage by shuttle cars and electric belt. Personnel and supply transportation is by electric rail system. Primary power distribution is 7,200 VAC with rectification to 300 VDC for the electric locomotive trolley system. Both shielded and unshielded DC motors are employed. All mine lighting is by cap lamp and vehicular lighting. The mine is classified as a gassy (methane) mine.

## **(2) Total Communications Systems**

A surface radio system is in use and tied into the underground leaky feeder radio system. Although interconnection of both systems is possible electronically, this feature is not used very often. The mine also has its own PBX telephone system with rotary dial capability extended underground. This telephone system is the main form of communications to and from the surface. A Gai-Tronics dial pager phone system is also in use in the mine.

## **(3) Description of the Leaky Feeder Communication System**

The mine has a rather large radio system for use underground and on the surface. Although the underground system and the surface system may be interconnected at the main remote control console, they are primarily used independently of each other. The underground system is used almost exclusively for control of the electric rail personnel and supply haulage system. It is occasionally used for direct communications between the hoise operator and underground personnel. Peak usage coincides with shift changes and routine supply drops.

The underground portion of the system presently employs three UHF (450 MHz) repeaters and approximately 4 miles of Radiax. The system layout is shown in Figure 3.19. Repeater No. 1 is permanently located at the base of the slope with Radiax extending into the mine and up the slope to the portal. At the slope portal the Radiax is terminated into a ground plane antenna which allows access to the underground system with a surface portable or mobile radio. This configuration provides convenience as well as backup access to the underground system for the normal remote control equipment located in the hoist house. The remaining two repeaters are located within the main entries of the mine. The repeater system utilizes a receiver voting comparator located in the hoist house. The primary dispatch console (Figure 3.20) is also located in the hoise house.

Although the leaky feeder systems were envisioned as playing a far greater role in overall mine communications when associated with a Collins MCM, the system still fills an important communications need in the mine. All personnel and supplies are transported within the mine by rail and the system serves to aid in the coordination of the rail system. It was reported to be extremely useful at major switching points within the rail system. It can, of course, be utilized in case of a mine emergency. The majority of mine-to-surface communications is provided by the Gai-Tronics dial telephone system.

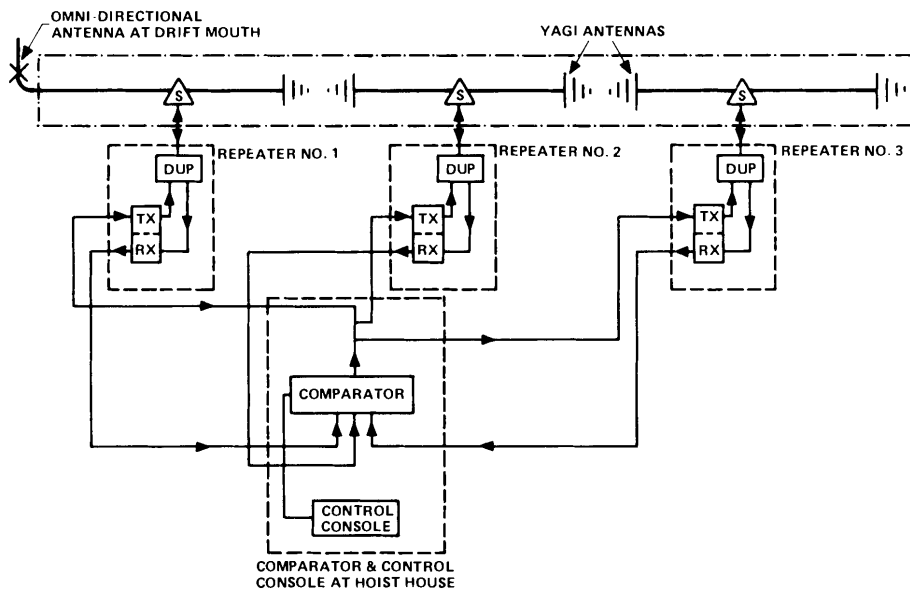


Figure 3.19. System Layout, Mine C.

Although motorcycle type mobile units were initially employed, the mine management sought a less expensive alternative for underground service. Through considerable research on the part of maintenance personnel an alternate solution was found. Currently the less expensive Mocom series of radios are procured from Motorola. These radios are then shipped to a private subcontractor who performs the following modifications:

- a. Fabricates an enclosure in which to mount the radio
- b. Installs a ni-cad battery within the enclosure for backup
- c. Installs a power supply module to convert 300 VDC to 12 VDC
- d. Installs a motorcycle control head so that the enclosure may be mounted remotely from the equipment operator.

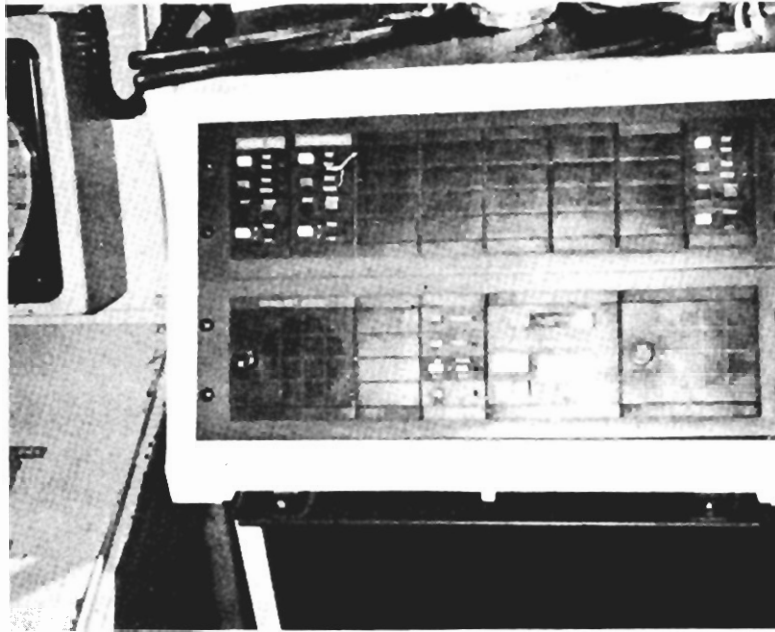
Views of the radio package and its interior are shown in Figures 3.21 and 3.22.

#### **(4) Equipment Description**

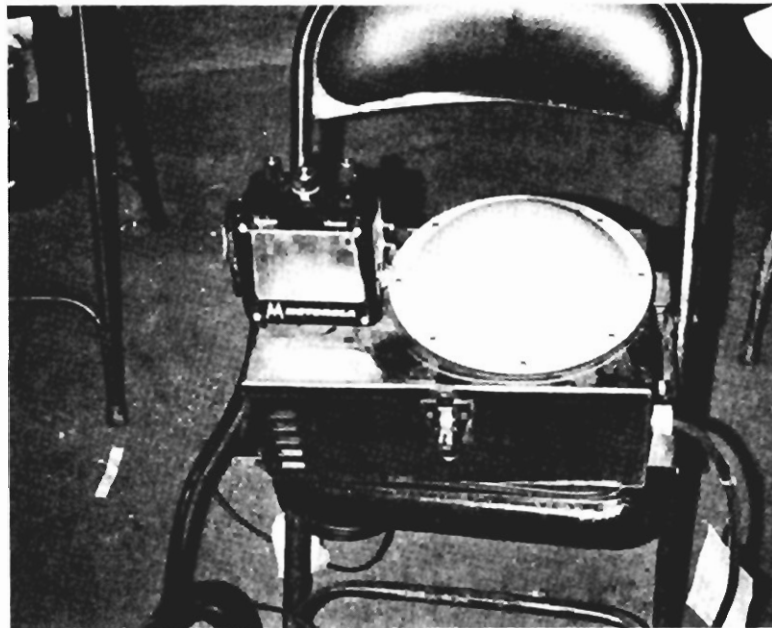
All radio equipment was furnished and installed by Motorola. The present complement of equipment used for the underground system is:

- 1 Master control console
- 1 Voting comparator
- 3 UHF Micor repeaters
- 10 Portable radios
- 20 Modified Mocom mobiles

The Radiax is Andrew 1/2 inch and is suspended from roof bolts and conventional cable hooks. All end cable runs are terminated in UHF yagi antennas which serve to properly terminate the radiax as well as extend the useable radio coverage off the ends of the cable to cover an approximately 200-300 foot gap between the end of one cable section and the start of another.



**Figure 3.20.** Primary Dispatch Console Located in the Hoist House.



**Figure 3.21.** Typical UHF Mobile Radio Package Used on Personnel Haulage Motors (Radio, Enclosure, Control Head and Antenna).



**(5) Procurement Background**

The mine's initial procurement efforts were oriented around the purchase of a Collins MCM System (Mine Communications and Monitoring System) to which Motorola was to supply the radio communications in a joint bid with Collins. However, the Collins MCM did not materialize and the mine continued to pursue the concept of a stand-alone radio communications system such as that offered by Motorola. The result was an abbreviated radio system. The complete leaky feeder radio system was supplied and installed by Motorola in early 1977 and was operational by 1978. Initially all underground mobiles were motorcycle type radios augmented by portables with converta-com units. Due to the high expense of the motorcycle radios, the mine later turned to the Mocom mobile radio modified for use in the mine environment as previously described.

**(6) RFI Problems**

During initial installation, standard pager phone wire was utilized to interconnect the repeaters, control console and the receiver voting comparator. This cable was not shielded and this resulted in 120 Hz rectifier hum from the trolley power system being coupled into the radio system audio. The problem was later corrected by the replacement of the pager phone wire with shielded twisted pair audio cable. No other RFI problems were reported.

**(7) Problems of the Mine Environment**

The major difficulty reported seemed to be the hearing and understanding of voice communications over the radio in the high noise environment created by the continuous miners. It was noted that mine workers refuse to use such items as hardhat headsets or lapel mikes.

The converta-coms which were installed in the underground environment did not hold up well to the corrosive atmosphere. The units have since been removed from underground service and replaced with either mobile radios or portables which are exchanged at the end of each shift.

**(8) Current Level of Performance**

In the limited application for which the communications system is used, it performs very well.

**(9) Maintenance**

The mine performs as many of the routine maintenance functions as possible. This in-house maintenance includes swapping of major components with spares kept on site, installations and removals of mobile radio equipment, and minor preventive maintenance which includes cleaning and battery maintenance at 30-day intervals. The in-house maintenance staff includes one electrical supervisor, one FCC licensed radio technician and one telephone technician. The in-house staff is also responsible for the maintenance of other electrical systems within the mine complex including a Gai-Tronics Dial phone system and PBX telephone switchboard equipment.

All component level maintenance on the radio equipment is performed by an outside service agency under a time and material maintenance contract. The mine has no access to radio test equipment even though one technician is FCC licensed. It would appear that management considers the cost of such test equipment uneconomical in light of the current size of the system and its use.

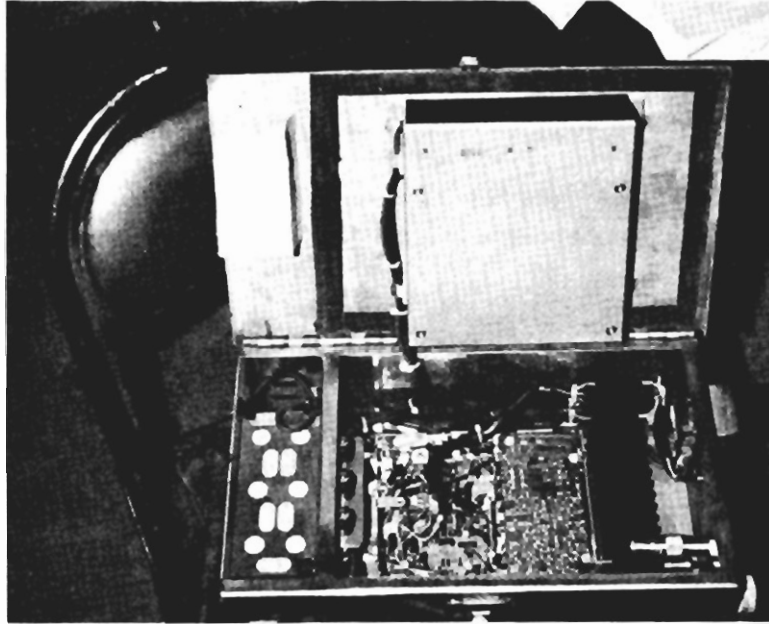
**(10) Costs**

The initial procurement of communications equipment cost the mine approximately \$78,000 and included only two repeaters underground, two remote control consoles, 4,000 feet of radiax and ten portables. Since that time additional equipment has been added to the system including two additional repeaters, 15,000 feet of radiax, ten more portables, twenty modified Mocom and mobiles various miscellaneous hardware. The total system cost to date is estimated to be \$150,000. These figures include equipment used in both the underground and surface systems.

The annual maintenance, including in-house maintenance cost and the time and material maintenance contract, totals approximately \$10-\$17 thousand.

**(11) Benefits**

Like Mine A, the leaky feeder system was installed new during the early development of the mine. No comparison can be made by management as to effects on production and no direct tie to safety can be made as there have been no major incidences in which the communications system was needed. The single most obvious benefit is that of convenience and smooth operation of the electric rail system (Figure 3.23).



**Figure 3.22.** Internal View of Custom Radio Enclosure. Power Supply/ Battery Charger on Door, 12 VDC Battery on Left End, and Modified Mobile Radio on Right.



**Figure 3.23.** Snapper, Hooking and Unhooking Cars, with UHF Portable Radio in Upper Right Pocket.

**(12) Attitudes of Miners and Mine Operators**

The leaky feeder radio system meets the expectations of management. Management feels that operational costs are reasonable for the benefits and use derived from the system. Management also feels most miners that are associated with the system like the system and consider it useful. As with other mines surveyed, operator abuse of the equipment seems to stem from their lack of knowledge of proper operating procedures and cost of such equipment.

**(13) Plans for Expansion**

Management is reviewing the benefits of expanding the system both above ground and below the surface toward the working faces.

**(14) Management Recommendations to New Purchasers**

Management seems to feel that the purchase of the radios system even in the absence of the original applications was correct.

They recommend that prospective new purchasers contact operators of existing systems in order to avoid procurement pitfalls and start-up problems caused by lack of information on the use of radio systems of this type in a mining environment.

**3.2.4 Survey Data – Mine D**

**(1) Description of the Mine**

The mine is located in the southwestern area of the United States. It produces approximately 980 thousands tons of copper ore annually (at an approximate value of \$88 million). A stoping mine plan is used employing drill and blasting. Ore haulage is by a combination of battery powered electric locomotive, diesel locomotive and hoist skip. The mine employs only AC power with a primary distribution system of 4,160 VAC. Locomotive motors are shielded to reduce RF interference. All permanent stationary lighting is mercury vapor.

The mine can be classified as wet and has working temperatures in the 100°F range with humidity approaching 100 percent. Rock pressures are extremely high forcing heavy timbering. Due to heaving of the floor it is necessary to excavate the drifts occasionally to keep the rails operable.

## **(2) Total Communications Systems**

This mine uses a Bell type PBX rotary dial telephone system for surface communications. This system is also configured for site-wide one-way paging using industrial paging speaker equipment. Talk-back in response to a page is accomplished either through the dial telephone or the leaky feeder radio system.

## **(3) Description of the Leaky Feeder Communications System**

The leaky feeder radio system, operating in the VHF (150 MHz) range, is used primarily for management, operation and maintenance of the underground ore haulage system. Additionally it is used by production supervisory personnel, mine maintenance personnel and safety personnel. A system layout is shown in Figure 3.24.

The system currently uses a single VHF repeater positioned a short distance from shaft No. 9 on the 3500-foot level of the mine. In addition to the normal repeater function, there is surface control via a remote control console operating with DC control signals. This system is somewhat unique in that it serves the communications needs of several levels of the mine, i.e., the 3200-, 3400-, 3500-, and the 3600-foot levels.

At the present time leaky feeder cable layout coincides with the primary haulage track on production levels.

The surface remote control console is located in the mine Production Manager's office, although it is not manned continually as a dispatch point. The system is also used for some paging. The paging encoder is configured for single unit paging or group paging. This will allow, with the expansion of the total number of pagers, for the paging of individuals or entire work crews. This will depend on the makeup of the pager groupings and assignments.

Mobiles and portables are equipped with two channels, one for normal repeater usage and one for unit-to-unit talkaround which bypasses the repeater. When units are using the talkaround channel, they are still able to receive transmissions directly from the repeater.

The mine has undergone substantial modernization and upgrading over the past five years. With the sinking of a new shaft, new production areas were established utilizing a combination of new equipment (jumbos) and the existing haulage equipment. The primary mine communications underground is a dial telephone with a speakerphone system as backup. The radio system serves as an enhancement to general communications. It is used in the maintenance of the mine and operation of the haulage system. Some paging is employed.

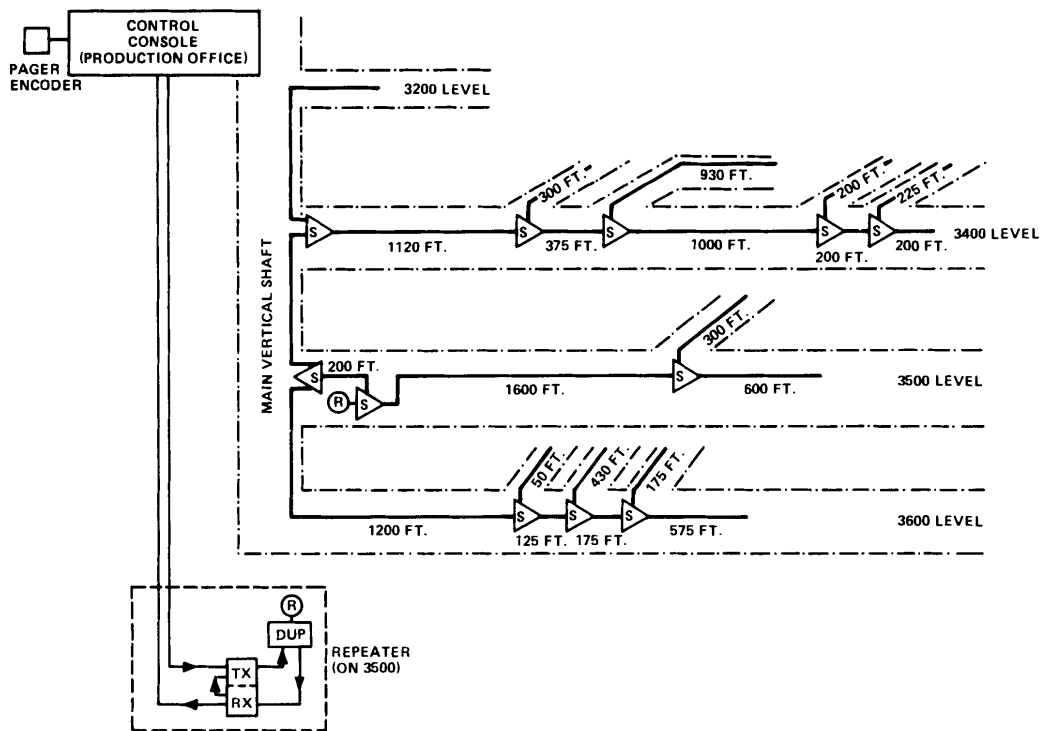


Figure 3.24. System Layout, Mine D.

Several operational and component changes were made since the time the system was first installed. Initially the radios underground were multiple channel radios with features such as external microphones. These accessories were severely abused and found to be a major source of radio failure. The availability of multiple channels allowed individuals to change channels for individual communications and then make themselves unable to be reached on the primary communications channel. These problems are currently being solved by making all radios single channel and by removing the external accessories such as microphones from the portables.

#### **(4) Equipment Description**

All equipment was supplied by Motorola but was installed by mine maintenance personnel. The underground equipment complement consists of:

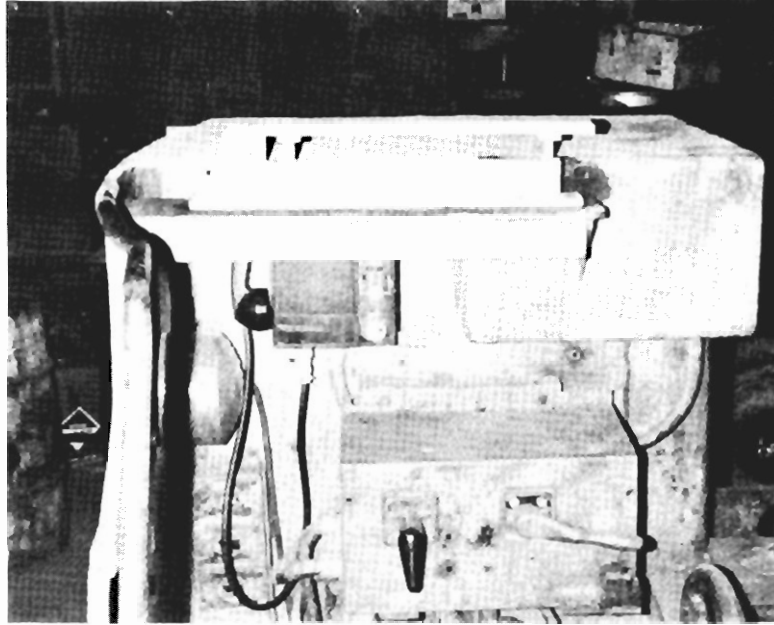
- 1 Micor VHF Repeater
- 8 Micor railroad radios
- 16 Portable radios (mixed HT220's and MX330's)
- 1 Multiunit portable charger
- 4 Pocket pagers (Director Series)
- 1 Multiunit pager charger
- Sinclair Excaliber antennas
- 1 Remote control console with paging encoder.

Views of an antenna and a mobile radio mounted on a rail motor are shown in Figures 3.25 and 3.26.

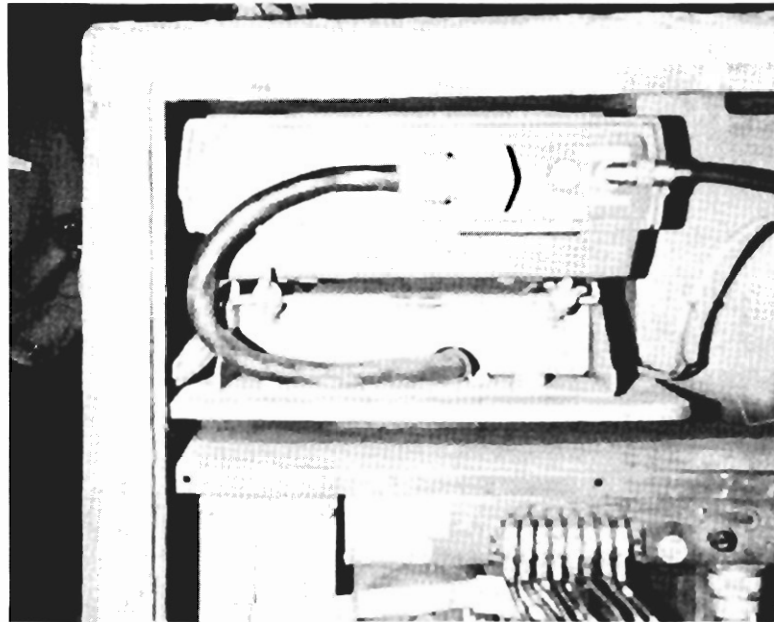
All of the leaky feeder cable is Andrew 1/2-inch Radiax. The cable is suspended from the roof by means of a 1/4-inch steel messenger cable attached by standard roof bolts. As originally installed the leaky feeder cable was situated a minimum of 12 inches away from all other power and telephone cables. Ends of the radiax are not terminated but are left open circuited and sealed with electrical tape. This does not appear to be a problem because RF coverage is sufficiently high in the desired areas of communications even at the standing wave minima.

#### **(5) Procurement Background**

Initial procurement investigation commenced in late 1975. Installation started in early 1977 with the first radios operating on the leaky feeder system in mid 1977.



**Figure 3.25. Railroad Style VHF Antenna Mounted on Battery Operated Rail Motor.**



**Figure 3.26. Railroad Style Mobile Radio Mounted in Electrical Compartment of Rail Motor.**



The procurement was initiated by the mine management through inquiries to the three major radio equipment manufacturers. Motorola was the only firm to respond. No detailed technical specification was developed and leaky feeder cable was not specifically requested. The resultant contract was for equipment only and the mine personnel performed all fixed plant cable and mobile installations following the recommendations of the vendor. According to mine personnel, there were no significant startup problems and the system was reported to be living up to expectations.

**(6) RFI Problems**

There were no RFI problems reported nor were any discovered by the survey team.

**(7) Problems of the Mine Environment**

Because of the extreme rock pressure, some portions of the various drifts must be shored, and occasionally reshored with 10"X10" or 14"X14" timber. When this occurs, all cabling must be removed from its mountings and reinstalled when shoring is completed. In many instances, it was observed that the Radiax and its messenger cable were not reinstalled in the same manner as it was originally. A typical problem is slack or insufficient clearance between the Radiax and passing motors. On several occasions the Radiax became entangled with a passing motor and cable damage resulted.

The messenger cable originally installed was 1/4-inch aircraft control cable. Due to the corrosiveness of the water within the copper mine this cable has deteriorated and broken in several places. Plans are to replace existing messenger with 1/4-inch stainless steel cable as well as use it for new installations.

Due to the high humidity, water and mud, all portable and mobile radios must be cleaned and inspected frequently. Portables have suffered some damage due to operator abuse. To date, only one portable has been totally destroyed because it was dropped into an acidic pond. Flex antennas which are used on the portable radios seem to have a fairly high fatality rate. It was felt by maintenance personnel that the antenna was simply not flexible enough to withstand catching of the antenna in ladder rungs, against shoring, etc.

**(8) Current Level of Performance**

At the present time the single repeater system serves the major portions of the haulage system very well. All main drifts are approximately 12' by 12' or smaller and the haulage motor operators report continuous saturation coverage. Communications into cross-cuts with 5 watt portables is limited to 30-50 feet on the average. Pager performance (selective calling) is reported to be very satisfactory for as much as 300 feet from the cable. This is likely attributable to the fact that tone decoding is not dependent upon voice intelligibility.

All motor radios have been detuned and now operate with a power output of approximately 10-15 watts. This was done in preparation for the implementation of a new electronic blasting system which never materialized. However, since system performance was not degraded, low power operation of the motor radios still continues and it is anticipated that as the system expands, motor mounted mobiles will be replaced with less expensive, more versatile portables.

**(9) Maintenance**

All component level maintenance performed on the leaky feeder radio system is accomplished by contract maintenance. This contract calls for all radios, except the repeater, to be serviced on the surface. This contract covers only the actual radio, not accessories like DC-DC converters, filters, etc.

Installations, preventive maintenance routines, and antenna/cable replacement and repairs of non-RF devices are completed by in-house instrumentation maintenance technicians. The instrumentation shop consists of one supervisor and six unlicensed general electronic technicians. This staff also maintains general mine instrumentation, a mine owned PBX dial telephone system used above and below the surface, the pager phone system and other (surface) radio systems.

**(10) Costs**

The initial leaky feeder communications system expenditure was approximately \$45,000 for materials only. No estimates were available for in-house labor expense for installation. The procurement of additional equipment, both operational and equipment procured for expansion in the immediate future bring the total equipment expenditure to approximately \$84,000. Direct maintenance cost for last year totals approximately \$2,300 (\$580 for in-house labor; \$1,500 for contract maintenance, and \$200 for miscellaneous parts not covered under contract).

**(11) Benefits**

Most miners and management feel production efficiency and general maintenance effectiveness have been improved by the use of the leaky feeder radio system. Safety personnel point to the radio system as an asset to the mines safety program.

**(12) Attitudes of Miners and Mine Operators**

When the system was first installed the miners at this mine, like others, felt that the radio system was just another management tool to keep an eye on them. The vast majority have now come to develop the attitude that the system is useful and aids in reducing their workload. Production supervisors appreciate the radio system as it allows them to eliminate substantial walking while maintaining direct communications with several of the miners they oversee. They feel this increases their productivity as supervisors as well as enhances the safety for all of the workmen. The radio system now appears to meet all of the needs of the persons using it and the general attitude is that it should be expanded throughout the mine to improve mine communications.

**(13) Plans for Expansion**

A second repeater and additional portables are on order for expansion of the system in the immediate future. It is desired to expand the cable to the stopes and development faces. It is also forecast that further pager operation will be implemented.

The mine is presently experimenting with the use of the radio system for controlling the dumping of ore from one level to another in an effort to speed the process and improve safety. When ore is dumped from one level to the next (approximately 100 feet vertically) the person controlling the dump and the person at the level overseeing the receiving of the ore must communicate over telephones located away from the ore chutes. The present operation can be hazardous as it does not provide real time communications at the points where ore is loaded and received. It is felt that the radio communications would be far superior and should be implemented.

**(14) Management Recommendations to new Purchasers**

Management feels their purchase was correct. It is felt, especially by production personnel, that additional equipment should have been installed with the initial procurement.

As did many other management personnel, this mine feels that new purchasers should contact current operators of radio system in order to educate themselves with the benefits as well as the problems associated with this type of communications system.

Mine management expressed the opinion that top of the line portables are not necessary for the vast majority of underground operations. It is felt that the operator control should be at a minimum to prevent tampering, overly complicated operation and because less sophisticated circuitry maintenance costs should be less.

### **3.2.5 Survey Data – Mine E**

#### **(1) Description of Mine**

The mine is located in Appalachian mountain range of the United States. It is one of several mines on the same property, all served by a single processing plant. While it is a relatively new mine and is in the development stages, the mine produces approximately 54,000 tons clean coal per year (at an estimated value of \$1.19 million). It employs a room and pillar method using three continuous miners. The ore haulage system is electric belt with shuttle cars supplying feeder breakers from each of the miners. The personnel haulage is battery powered rail vehicles. Primary power distribution is 7,200 VAC with reduction to 575 VAC for equipment at the face and 110 VAC for normal domestic equipment. No Direct Current (DC) is utilized in this mine.

#### **(2) Total Communications Systems**

Communications on the surface is provided for all of the mines on the property and the processing plant by an extensive VHF two-way radio system supporting as many as 50 mobiles. Underground communications in all mines on the property are provided by Gai-Tronics pager phone systems augmented in two mines with leaky feeder radio. The remaining mines use a trolley wire style radio system.

#### **(3) Description of the Leaky Feeder Communications**

The leaky feeder radio system operates in the UHF (450 MHz) range and is utilized entirely for the operation of the personnel haulage system. The system is a single repeater system and does not use a receiver voting scheme. A single dispatcher is located in the lamp house and normally controls the system through the use of a standard DC remote control unit. He also has the capability of interconnecting the radio system and the pager phone system such that dispatch functions can be done from a pager phone location. A system layout is shown in Figure 3.27. The UHF repeater station is shown in Figure 3.28.

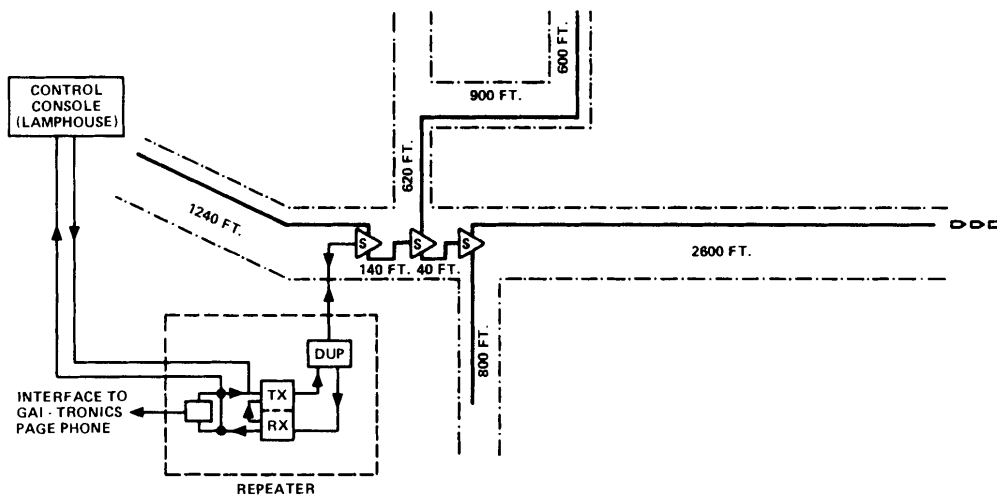


Figure 3.27. System Layout, Mine E.

#### **(4) Equipment Description**

All equipment was furnished and initially installed by Motorola. Currently in use within this mine is a single UHF repeater station (70 watts) and three to five mobile radios (25-35 watts) mounted on rail vehicles (Figure 3.29).

The leaky feeder cable is Andrew 1/2-inch Radiax and there is approximately 6,900 feet in place at the present time. The cable is suspended by securing it to the roof bolt plates at approximately 40-foot intervals. As in most installations, the cable is fed from the center via a two-way splitter as shown in Figure 3.30. Ends of the Radiax cable are not terminated, but left open-circuited. As with previous mines visited, no problems were reported nor seemed to be caused by this open-circuited cable.

#### **(5) Procurement Background**

Procurement was initiated by the mine through Motorola who was the supplier of the extensive surface two-way radio system. The mine company owns and operates the several mines on the property in addition to processing facilities. The surface radio system evolved over the years to serve this complex. Since Motorola furnished and installed this surface system, they were the logical point of contact to fulfill the company's requirements of underground radio systems.

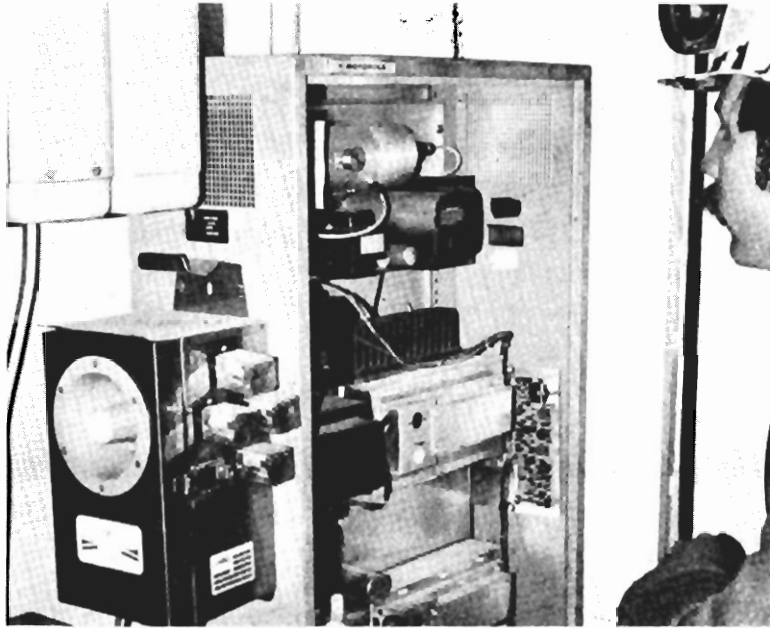
The initial procurement called for sufficient equipment to equip six mines with single repeater leaky feeder radio systems. The radio equipment in Mine E was installed in 1978-79. Some of the mines were "short life" operations and have since closed down. One was recently converted to a Femco trolley wire system to provide the required man trip coverage. At the time of the survey, only two of the mines were still equipped with a leaky feeder system.

#### **(6) RFI Problems**

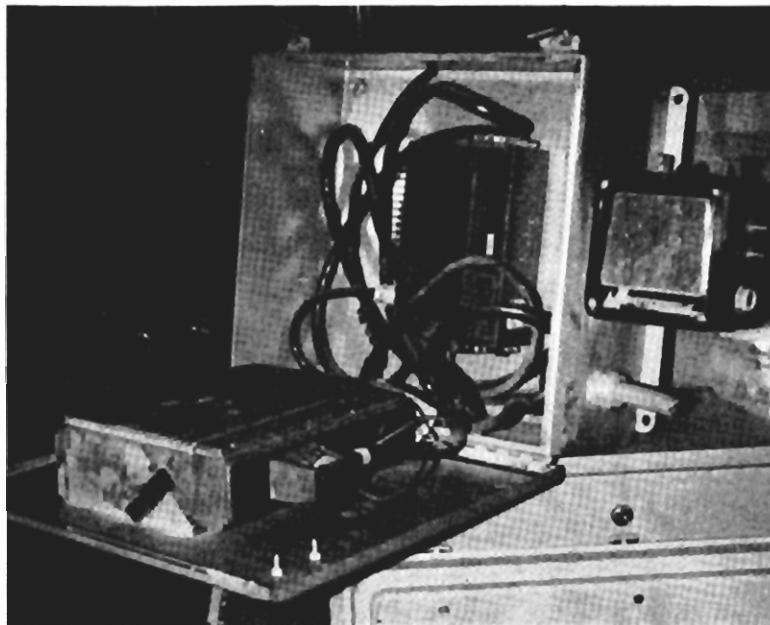
No interference problems were reported nor were any discovered by the survey team.

#### **(7) Problems of the Mine Environment**

The radio equipment seems to suffer a normal amount of abuse. It was reported that damage to Radiax bordered on the abnormal side. When this was investigated further it was discovered that Radiax is occasionally removed from one of the short life mines to be



**Figure 3.28. Photo of Underground UHF Repeater.**



**Figure 3.29. Repackaged UHF Mobile Radio for use on Mine Vehicles.**

relocated to another mine. The method used in removing the Radiax was to drop it from its hangers and drag it out to the portal with a rail vehicle. This practice would tend to distort the radial construction by stretching it from its own weight and drag as well as cause a great amount of damage to the protective outer jacket.

During the investigation of the system within the mine itself several nonstandard practices were uncovered concerning the installation and maintenance of the Radiax cable itself. At the termination of the main entry run of cable, it was discovered that the cable was held in place by bending it immediately back upon itself through an eyelet (Figure 3.31). This alters the electrical characteristics of the cable again by distorting it and could possibly cause a direct short of the inner and outer conductors. On another entry where the cable had been installed a partial roll of Radiax was still connected to the operating cable. Thirdly, it was discovered that electricians were never properly trained in the splicing of the cable and were subsequently not making splices with standard cable connectors but twisting the inner conductor together much as one would a common piece of stranded hook-up wire. This also alters the electrical characteristics of the cable rendering it far less efficient if not inoperable.

#### **(8) Current Level of Performance**

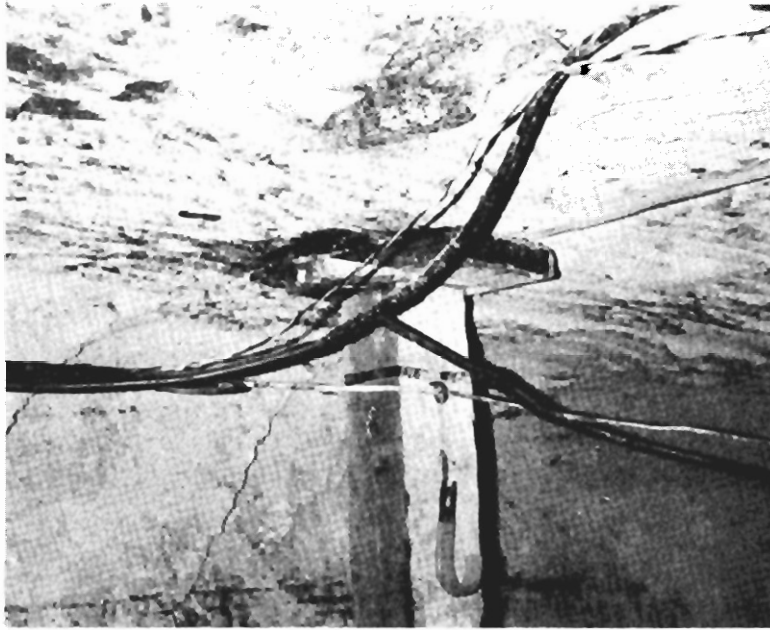
At the time of the visit, there were two leaky feeder systems in service on the property. A third system had recently been taken out of service and replaced with a trolley wire carrier current system. It was stated by those interviewed that neither of these systems were operationally up to standards. As for the mine actually visited, the inspection team found the repeater transmitter output (rated at approximately 70 watts) to be approximately 0.5 watt. The Radiax cable, as mentioned previously, was in various states of disrepair.

#### **(9) Maintenance**

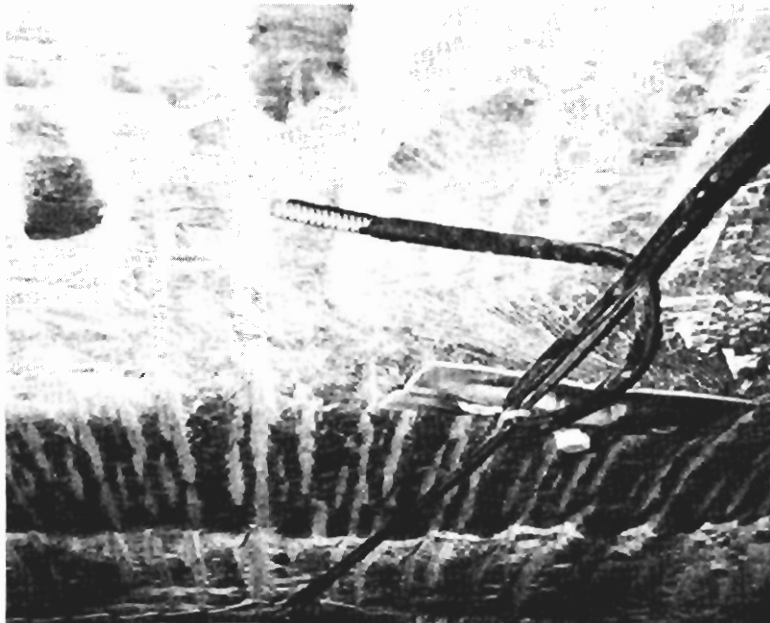
Maintenance of the leaky feeder radio system is presently in a state of suspension. Prior to this writing, maintenance had been under a time and material service contract to a local repair facility. There are negotiations currently under way with a new contractor in an attempt to procure better maintenance for the systems.

It was reported that approximately one year ago there were personnel changes in the area that was both responsible for the procurement of the underground radio systems and the administration of the maintenance contracts. Since that time there has been little, if any, management of the radio systems or the maintenance contracts that covered them. It





**Figure 3.30. Splitter Installed in Radiax Line.**



**Figure 3.31. Radiax, Improperly Bent and not Properly Terminated.**

was reported by the newly added personnel that there are two drastic problems created by this lack of proper management; (1) for the last year or so nearly anyone on the property could call out the maintenance contractor for even the most insignificant of problems and this eventually drove the cost of servicing these systems upwards of \$15,000 monthly; and (2) since maintenance was not properly overseen the system's overall performance has deteriorated to the point where upper level management has decided to do away with all leaky feeder systems.

**(10) Costs**

No accurate procurement costs were available from those the team had access to.

**(11) Benefits**

The main justification for the procurement of an underground radio system for each of the mines is that continuous communication is required on man trips by the West Virginia state mining laws under which this mine operates.

**(12) Attitudes of Miners and Mine Operators**

Until the deterioration of the system in the last six months or so, both the miners and management felt the system was a great benefit, enhanced the safety of the personnel haulage system and was generally an enhancement to the overall mining operation. The current attitude of the miners is one of dislike and distrust of the system. Management considers it to be uneconomical and totally unsatisfactory.

It must be pointed out that the personnel now responsible for the operation and maintenance of the radio system feel that the leaky feeder systems have been unfairly judged in light of the lack of proper management and the inefficiency of the former maintenance contractor. They make reference to the former acceptance of the leaky feeder radio systems by the miners before the recent deterioration.

**(13) Plans for Expansion**

As might well be expected, there are no plans for expansion of the leaky feeder systems at the present time. It was expressed that if the systems were to recover their status as viable communications systems then it would be desirable to expand these systems closer to the working faces and possibly make additional use of the systems by equipping maintenance functions

and perhaps supervisory personnel. However, since the mine visit, it has been learned that management had decided to replace the leaky feeder in mine E with a trolley wire carrier system. This will leave only one mine equipped with a leaky feeder system, which being a “short life” mine will probably continue to use the system until the mine closes down in the near future.

**(14) Management Recommendations to New Purchasers**

Management had no recommendations to new purchasers.

**3.2.6 Survey Data – Mines F and G**

**(1) Description of Mine**

These mines are located in Appalachian mountain range of the United States. Each mine produces approximately 290,000 tons clean coal per year (at an estimated value of \$12.7 million combined). One mine employs exclusively conventional cut, blast and load methods while the sister mine employs both conventional mining in addition to two continuous miners. The coal haulage system is electric belt directly to the processing facility which is located approximately 1/4 mile away. The personnel and supply haulage system is by battery powered rail vehicles. Primary power distribution is 7,200 VAC with reduction to 575 VAC for equipment at the face and 110 VAC for normal domestic equipment. No Direct Current (DC) is utilized in this mine.

Both mines are equipped with leaky feeder radio systems which are very much alike. Only one mine was entered and surveyed.

**(2) Total Communications Systems**

Surface communications is accomplished through a VHF surface two-way radio system. Mine communications is done primarily through the use of a pagephone system and is augmented by the UHF leaky feeder radio system.

**(3) Description of the Leaky Feeder Communications**

The leaky feeder radio system operates in the UHF (450 MHz) range and is utilized entirely for the operation of the personnel haulage system. The system is a two repeater system with a receiver voting comparator. A single dispatcher is located in the lamp house and normally controls the system through the use of a standard DC remote control unit. He also has the capability of interconnecting the radio system and the pager phone system such that dispatch functions can be done from a pager phone location. A system layout is shown in Figure 3.32. Installation of mobile equipment is shown in Figures 3.33 and 3.34.

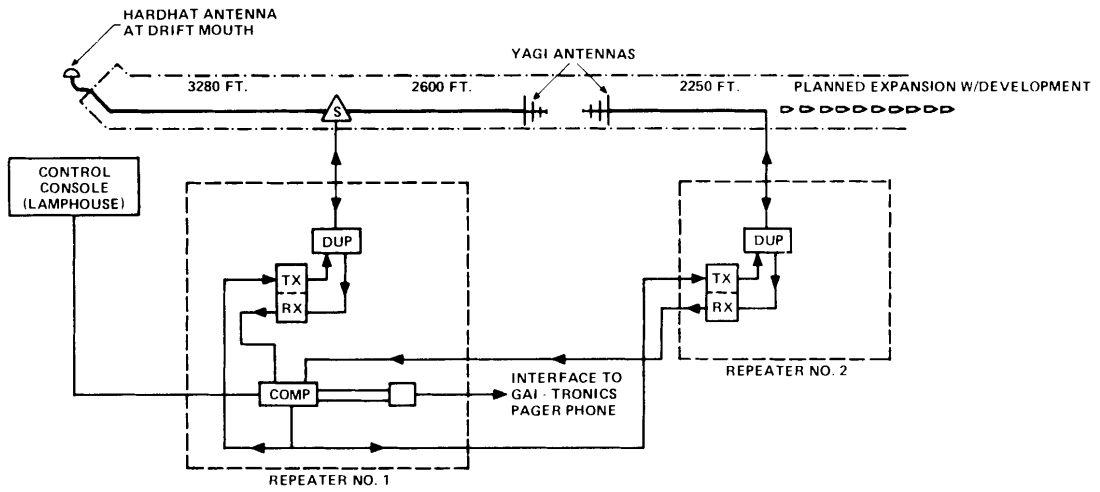
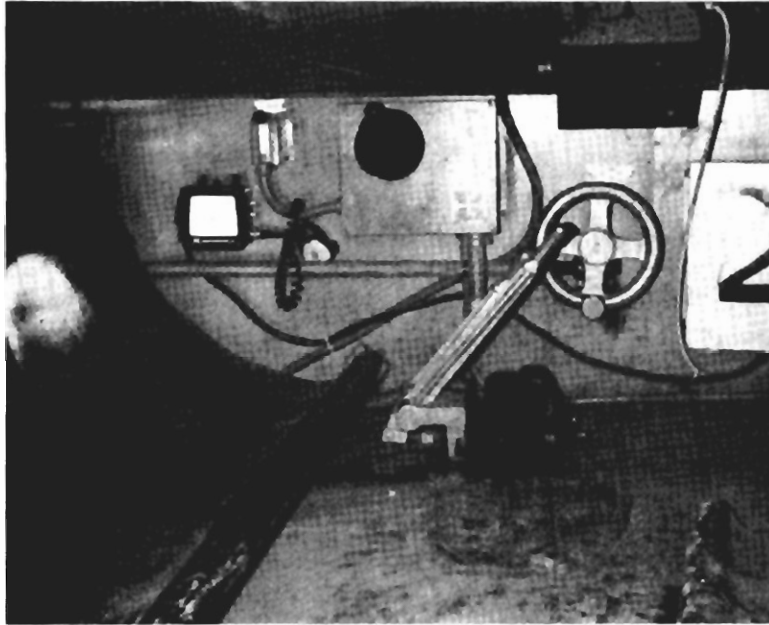
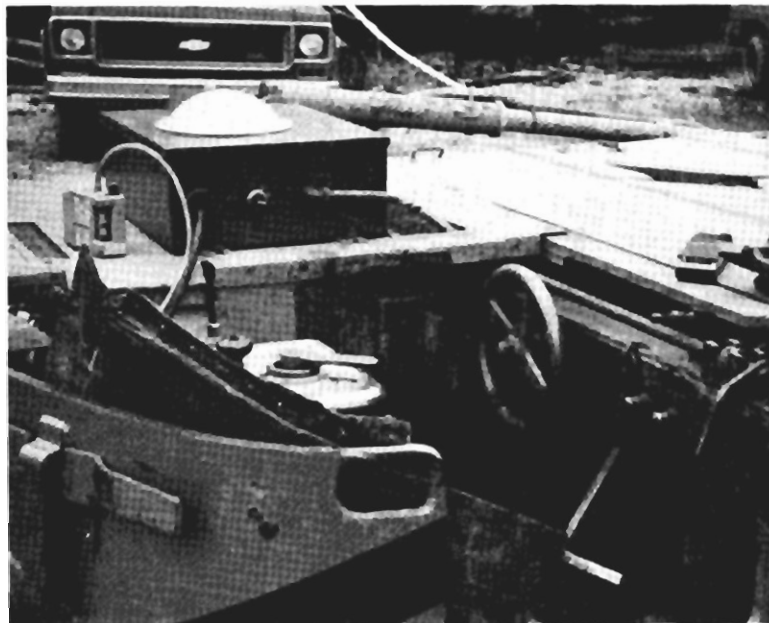


Figure 3.32. System Layout, Mines F and G.



**Figure 3.33. Radio Equipment Inside Mantrip Cab.**



**Figure 3.34. Photo of Rear Cab Area of Supply Motor. Hard Hat Mounted in Electrical Box.**

Operationally the system is used to control mantrip and supply train traffic in the single set of tracks on and out of the mine. No handheld portables are incorporated into the underground system. The dispatcher is located in the lamp house and logs all traffic movement.

#### **(4) Equipment Description**

All equipment was furnished and initially installed by Motorola. Currently in use within this mine are two UHF repeater stations (70 watts) and three to five mobile radios (25-35 watts) mounted on rail vehicles.

The leaky feeder cable is Andrew 1/2-inch Radiax and there is approximately 8,200 feet in place at the present time. The cable is suspended by securing it to the roof bolts. Ends of the Radiax cable are terminated in UHF yagi antennas to provide coverage between the end of one Radiax run and the start of another. The cable run up the entrance slope is terminated into a mobile radio style hard hat antenna at the portal for communication from the surface to underground radios.

#### **(5) Procurement Background**

Procurement was initiated by the mine directly to Motorola who supplied and maintains a surface radio system. It was not known if any written procurement specifications existed for the first equipment purchased but no technical specifications existed for subsequent procurements.

The initial equipment purchase was for a single repeater system for one mine in late 1976. This initial system was recently expanded in January of 1980 to include the addition of a second repeater and a receiver voting comparator. The sister mine was equipped with underground radio in September of 1979.

#### **(6) RFI Problems**

There were no RFI problems reported with the system. It was noted that due to the close proximity of the two mines (Figure 3.35) and the operation of both mine leaky feeder systems on the same frequency, there is co-channel (same channel or party line like) interference. This interference is only apparent to mobiles on the surface as both mines terminate the slope Radiax in a surface mounted antenna (Figure 3.36). The annoyance of this interference was reduced by adding tone coded continuous squelch to both systems. This effectively prevents a mobile from one mine from hearing signals from the other mine.

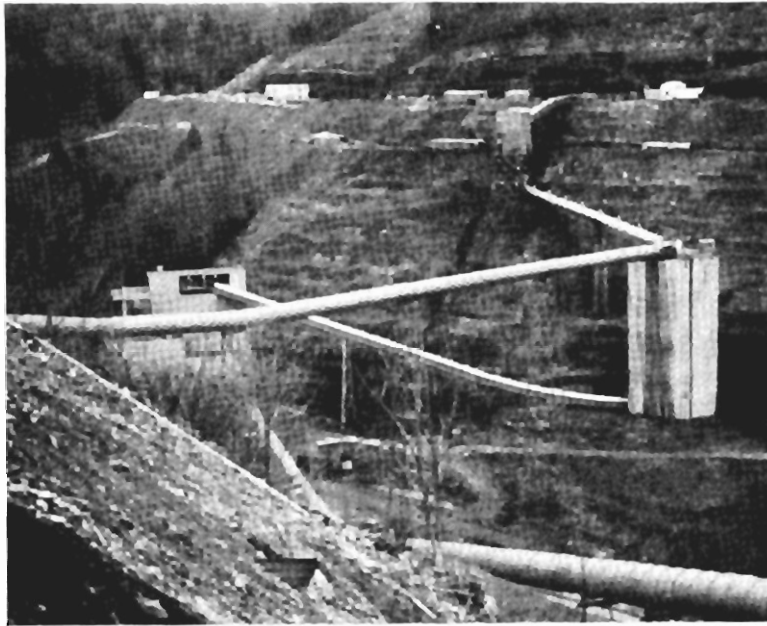


Figure 3.35. Processing Plant Located in Ravine Between the Two Sister Mines.

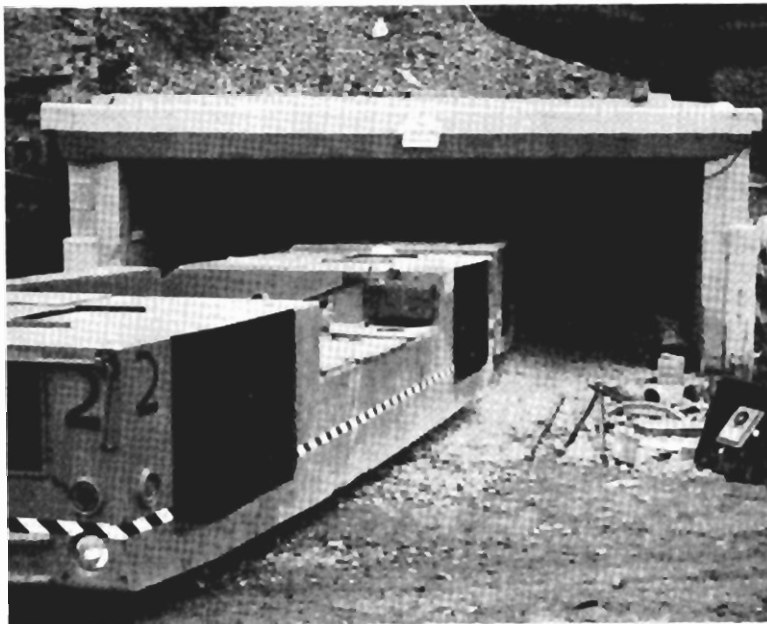


Figure 3.36. Main Entry Portal. Hard Hat Antenna Connected to Radiax is on Upper Right Rail Train Shown.

**(7) Problems of the Mine Environment**

No significant problems were reported by those interviewed in relation to the mine environment directly. It was pointed out that because of the way in which the battery connections from the mobile radio are made to the rail vehicle battery casing, power cable feeding the radios were frequently damaged and sometimes severed completely. This would appear to be a simple matter of installation mechanics and more than likely could be corrected by careful routing of all battery power cables.

**(8) Current Level of Performance**

The present level of performance seems to be satisfactory to those in charge of the systems.

**(9) Maintenance**

Maintenance on the radio electronics of the leaky feeder systems is accomplished through outside contract. This maintenance contract is a basic labor and minor parts contract with service being rendered on demand. Mobiles are routinely covered for service calls five days a week, 8 a.m. to 5 p.m., while repeater stations are covered 7 days a week, 24 hours a day.

Those who are responsible for the radio systems seem satisfied with the maintenance service rendered. All installations on underground vehicles and minor repairs or changes in the cable system are accomplished by mine electrical personnel.

**(10) Costs**

No accurate procurement costs were available from those the team had access to. It is estimated that the procurement cost of each system was approximately \$70,000. Since mine electrical shop personnel installed the Radiax cable the estimated labor cost was \$2,000 and the cable cost was \$5,000 per repeater station. The average monthly cost of the maintenance contract is \$400.00.

**(11) Benefits**

As with Mine E, the main justification for the procurement of an underground radio system for both mines is that continuous communication on man-trips is required by the West Virginia state mining laws under which this mine operates. This mine does however report the enhanced accessibility to repair parts from the surface through the use of the radio to plan and coordinate supply drops.



**(12) Attitudes of Miners and Mine Operators**

As is common in most of the mines visited, miners themselves feel that the radio system renders them too accessible to supervision and management. They do not apparently abuse the equipment and of course recognize that it is a state mining law requirement.

**(13) Plans for Expansion**

The company plans to expand both systems as the main entry advances with the working surfaces. At the present time this primarily involves the addition of leaky feeder cable to the inner most repeater in the older mine. A second repeater for the sister mine (originally equipped in 1979) is now in the planning stages.

**(14) Management Recommendations to New Purchasers**

Management felt that the experiences derived from several years of using their surface system better equipped them to cope with the procurement and operation of the underground systems. They recommend that new purchasers gain as much exposure to radio systems and especially mine oriented radio systems as is possible.

## **4.0 CONCLUSIONS**

### **4.1 Summary of Leaky Feeder Use and Justification**

There were a total of six mining companies visited and interviewed. These companies controlled, at the time of the interviews, ten mines in which leaky feeder communications were employed. Adding one mine that declined to be interviewed, these represent all the mines in North America using leaky feeders which could be found through queries of communications equipment suppliers and of other leaky feeder equipped mines. A summary of the communications systems used in these mines is given in Table 4.1.

It is concluded from the survey that the use of leaky feeder communication systems in North America has been limited and has been primarily the result of legal requirements. Two-way radio communications are required on all underground rail systems in the state of West Virginia, and have been required in other areas if more than one vehicle was to use the rail system at any one time. Given the requirements for two-way radio communication, the leaky feeder system was adopted at several mine sites. Other mines adopted the leaky feeder system solely on the recommendation of their communications equipment suppliers or to keep the underground system compatible with existing surface radio systems owned by the company.

Other rationale for installing two-way radio communications systems underground include reduced mine maintenance costs reported by a large Canadian mine through better use of their mechanics and perception of increased worker safety through the use of two-way radio. The mines have considered the expense of the radio systems with a cost of doing business (West Virginia mines) or a definite asset in terms of production and labor cost savings.

Because the use of two-way radio communications is not common underground, the variety of potential radio uses have not been entirely explored. Radio systems are primarily used as management tools for communication with workers in remote locations, and for traffic control on rail systems or haulage ways. The most common use of two-way radio communications underground utilizing a leaky feeder cable has been for the direction of traffic on railway systems. Use of the leaky feeder system allows continuous communications between rail vehicles and with a dispatcher. This eliminates the need for rail vehicle operators to leave their vehicle to visually check each intersection prior to passing it and to coordinate and time vehicle movements so that they do not inhibit each other. Use of the leaky feeder communication system has provided effective communications on almost all rail systems employing it, and has allowed at least one to increase its haulage capacity up to five times.

Table 4.1. Communications Systems Summary

Descriptions	Mines							TOTALS
	A	B	C	D	E	F	G	
Type of mine:								
Hardrock	X	X		X				3
Coal			X		X	X	X	4
Surface Communications:								
Two-way radio	X	X	X		X	X	X	6
PBX Telephone (mine owned)	X	X	X	X				4
Underground Communications:								
Pager-phone (no dial)	X					X	X	3
Pager-phone (dial)			X					1
Leaky feeder radio system								
Radiax cable	X		X	X	X	X	X	6
Twin-lead cable		X						1
Radio paging via Leaky Feeder				X				1
Carrier Current Radio system								0
PBX Dial telephone system		X	X					2
Characteristics of Leaky Feeder Sys:								
Multiple repeaters	X	X	X			X	X	5
Receiver Voting scheme	X		X			X	X	4
Hardwire Repeater interconnect	X	X	X			X	X	5
150 MHz band	X	X		X				3
450 MHz band			X		X	X	X	4
Type of Radio Equipment used:								
Standard radio repeater	X	X	X	X	X	X	X	7
Standard mobile radios		X			X	X	X	4
Railroad mobile radios	X			X				2
Repackaged mobile radios			X		X			2
Portable hand-held radios	X		X	X				3
Radio pagers				X				1
Maintenance:								
In-House	X							1
Contract					X	X	X	3
Contract with in-house support		X	X	X				3

A second use of the leaky feeder communication system underground has been for supervision of mechanics and production workers. Use of the radio eliminates the need to travel to remote locations or rely on pager phones for communication with workers. Mechanics and other production personnel that travel throughout the mine are much easier to locate using the radio, saving substantial amounts of “travel and location” time. Although several mines have found the leaky feeder communication system desirable from an operations viewpoint, there have been some substantial problems with installation and use of the systems.

Only one of the mines surveyed used radio between the mine foreman at each working area and the individuals responsible for haulage. A better coordination between various faces and the haulage system can ease production bottlenecks due to haulage limits as well as increase worker safety by coordinating remote operations that affect a wide area of the mine.

#### **4.2 Procurement Practices**

It was observed during the survey that a number of problems could be traced to procurement practices. Basically, procurement of leaky feeder systems were initiated without a complete understanding of the capabilities or pitfalls of such systems, and without adequately defining the needs to be satisfied. It was found that:

- In-house technical expertise was generally nonexistent or simply not sufficient during the planning and/or procurement stages of the system.
- Investigation of available equipments and sources for assistance was inadequate before procurement.
- The actual procurement was, in all cases except one, executed without the benefit of comprehensive technical specifications or even performance specifications by which the end product could be evaluated.

Procurement under these conditions can be the root of subsequent difficulties such as disappointment with the system’s performance and costly system reengineering to correct original design deficiencies.

### **4.3 Installation Practices**

The design and installation of the systems reviewed for this project indicate a wide variation in concern for maintenance and durability. Few systems have been specifically designed for the extremely rugged environment and the rough handling received by the untrained users. Although several systems were installed in locations that afforded the radio protection from falling objects and physical abuse, accessory components such as microphones and speakers were substantially less protected. Several locations used hard-hat type antennas designed for severe service. While these antennas were installed to provide antenna system protection, the antenna leads were routed over open areas of the equipment, exposing them to severe damage and abuse. Such inappropriate installations indicate a lack of awareness by the installer of the potential for abuse or simply a display of "lack of effort." It is also apparent that several installations were made with no concern for ease of maintenance. Radios were installed in locations difficult to reach or in such a manner that they require a significant amount of work to remove. If the radios were installed in such a way that they could be quickly changed out, spare radios could be installed while repairs were being made. Such a scheme would improve the apparent reliability of the systems by making them available for a greater percentage of the working hours. Other problems with the radios concern their basic design.

Repeater station installations could also be improved by providing more substantial cases with improved dust filtering capabilities. Many installations reviewed indicated a need for a cabinet which could withstand limited roof falls as well as provide clean cooling air. Cable installation and hanging techniques also varied widely by installation. It is apparent that many individuals installing the cables did not know how to correctly install the system or had not considered the possibility of physical abuse. The best installation technique was to hang the cable from the mine roof using plastic wire ties which would give under the load of small roof falls without causing damage to the cable. This system is rarely used. Cable termination techniques also varied widely but without a noticeable effect on system performance. One area where inappropriate technique did display a substantial degradation of system performance was in cable splicing or repair.

### **4.4 Maintenance**

Only one of the mines surveyed had a complete in-house maintenance capability. Others depended wholly or partially on contract maintenance by an outside radio shop. Three of the mines did routine repairs and replacement of defective components depending on an outside shop for troubleshooting and repair of the defective components replaced. One mine not only depended wholly upon outside maintenance but exercised no coordination over calls for service. Any miner could call for service even for the replacement of a microphone. This mine complained of exorbitantly high maintenance bills and yet the maintenance of its leaky feeder system was judged to be the poorest of all those surveyed.

It is concluded that active participation of properly trained mine personnel in the maintenance functions is virtually a necessity. A complete in-house maintenance capability may not be cost effective for a small operation. However, there appears to be a great advantage in assigning one or more radio trained mine employees responsibility at least for routine maintenance and component replacement level repairs. The maintenance contractor can then be limited to the repair of defective components and for on-call service when required by the in-house staff.

#### **4.5 Training**

It was found that without exception all mines were deficient in the proper training of personnel who were to either use the radio system or be affected by its usage. This lack of training contributes directly to many problems experienced by those surveyed. Several of these problems are:

- Inefficient implementation of the entire system
- Improper usage of the system
- Abuse of the equipment and thus higher maintenance costs
- And occasionally, nearly total rejection of the new system by miners and/or mine supervisors.

Some systems are fairly complex in their operation. Therefore, lack of instruction on the simple operational characteristics of the system can cause operators to assume a system malfunction when in fact the problem may be operator error. This applies equally to the mechanical operation of a piece of radio equipment itself.

Upper levels of mine management do not always take into account the fact that many of their miners may look upon the system as just another piece of equipment to carry. Also it is often viewed as another management trick to spy on their everyday movements and work efficiency. Much of this attitude can be attributed to lack of understanding of what the system is intended to do, both for the benefit of the miner as well as the mine owners.

#### **4.6 Miner Attitudes and Acceptance of Radio Communications**

The effectiveness of the communications systems has been severely hampered at several locations due to inadequate understanding by company personnel of the requirements for the installation and maintenance of the systems. Initial startup problems characterized by repeated system failures was common at most sites visited. This severely hampered the effectiveness of the systems due to the negative impression it left on the system users. At several locations the system was not reliable enough to be used for management functions or traffic control without a backup. This led to a very poor acceptance of the system by the workers as well as management. Only after several months of system use and improvements in the in-house maintenance capability have these systems grown to be tolerated by the workers and management. For the average installation it took approximately one year for the system to become fully functional, both from a reliability and worker acceptance standpoint. Another major problem with the use of the leaky feeder systems has been a lack of understanding by both management and workers of how to use the system and its actual capability.

Very few leaky feeder installations are being used to their full extent by the mines. Each firm has a specific preconceived use for the system and has not explored other possible uses. In most cases the system user has not been trained in the use of the system, nor does he understand its primary function. This lack of training has hampered the startup of several systems as a result of individuals resisting its use or failing to use it properly. It is apparent that the usefulness of almost any leaky feeder system visited could be substantially improved through an employee and management training program in which proper radio use is explained, and samples of potential uses for the radio presented. Education should also reduce the abuse the systems receive.

Because the radio systems reviewed during this project have been unable to cope with “normal” underground abuse, miner attitudes towards these systems have been significantly influenced. Many radio failures have been and are likely to continue to be compounded by miner’s attempts to “repair” radios by banging them on a hard surface. This sometimes works (by improving conductivity of corroded battery or volume/squelch control contacts) thus encouraging this behavior. However, the net result is degradation and eventual damage which then reinforces the attitude that the radio system is not appropriate for underground use. Few workers understand the sophistication of the system and do not comprehend its cost. In mines where the maintenance and training functions have been best, worker acceptance of the system has been best. It is apparent that these are related factors.

Many installations include two-channel transceivers, allowing the operator to choose a channel for communications. This option often defeats the purpose of increased communication capacity by allowing many users to be on the inappropriate channel either by accident or by design. Miners quickly learn that if they do not want to be contacted they could turn the volume down to a point at which it could not be heard or simply leave the radio on the wrong channel. The controls on many radios have also shown their inability to handle the harsh environment and abuse. The most common complaint with the radio systems was the continual failure of volume controls, channel select switches, remote microphone-speaker combinations for portables, and any other such external options or controls. The unanimous opinion of all persons interviewed is that the ideal radio would have only an on-off capability and rugged volume and squelch controls. All other options would be eliminated. It is also apparent that mobile equipment radios should be installed in such a fashion that the microphone is protected while in a stowed position, and yet is easily reached. Numerous complaints were received from system users that microphone failures were extremely common and that these items received extreme abuse.

#### **4.7 Cost Effectiveness**

A consideration of cost effectiveness is a direct response to question 1 in Section 1.1 of this document. The procurement of leaky feeder was invariably associated with the objective of increasing production. Even in those mines where it is installed merely to meet a legal requirement it is most often tied to some direct production function and not to a management or safety purpose. At all but one location the system was perceived by management as meeting this objective. Although only one mine could show an increase in production directly attributable to the radio system, the other users also felt production was increased. In the one case, the mine considered that the radio made it possible to increase production from an annual gross of about \$2 million to nearly \$10 million. This was accomplished by a capital investment of \$800,000 and an estimated annual maintenance cost of about \$25,000. This increase in production is a direct result of the greater number of trains that can be operated on the same track because of a continuous communications capability. Other mines reported that benefits were realized because of improved haulage, supply delivery and repair.

Improvement in haulage efficiency attributed to the radio system is the result of improved load-haul-dump cycle timing, reductions in accidents, and increases in the number of haulage vehicles. Use of the radio system has allowed improvement in the load-haul-dump cycles of several haulage systems by improved timing, which reduces waiting time for loading or dumping. By



having the haulage vehicles arrive at the production loading area when material is ready to be loaded, and not having to wait to be loaded or not having the capacity to “keep up” with production, fewer vehicles are required. Not having to slow production to wait for haulage vehicles allows more ore to be mined with fewer vehicles. At one mine visited the production foremen were in radio contact with the rail haulage vehicles at all times, and could always know when they would return to be loaded. This allowed the foremen to adjust the mining cycle to match the capability of the haulage system, eliminating nonproductive waiting time.

No accidents were reported on haulage systems employing radio communications. These mines did report accident histories prior to radio installation. The reduction in accidents directly increased production. At one mine this saving, or more realistically, increase in production was substantial. Accidents prior to the radio system installation stopped production for an average of 14 days. With the current production rate of 50,000 tons per day the annual production of the mine has increased approximately 700,000 tons per year due to accident reductions.

Production increases and cost savings have also resulted from use of the radio system to order supplies and repairs. The use of the radio system has demonstrated significant savings by allowing supply orders to reach delivery vehicles prior to arrival at working areas. Changes or additions to the order do not need to be made after the supply vehicle reaches the working area, often allowing substantial savings in the required travel distance and time needed for the additional items.

Maintenance costs can also be reduced through the use of the radio. Accurate descriptions of the failure and failed parts can be given to mechanics at a remote location while looking at the machine needing repair. This eliminates the need to remember the failure or parts from a fixed phone to the machine to describe failed parts and systems. The mechanic can help the person on the machinery troubleshoot the failure, often eliminating the need for him to travel to the broken machine. This improved communication also allows the mechanic to bring the needed parts and tools to the scene, without first going there to identify the problem. At one mine the savings in maintenance cost and an increase in production due to improved machine availability has paid for the radio system many times.

#### **4.8 Intangible Benefits**

This subject deals with question 2 in Section 1.1. Although no systems were purchased solely for the purpose of mine safety, nearly everyone interviewed at each mine agreed that worker safety was enhanced by the radio. The users felt that the radio would allow faster response during mine emergencies, as well as allow redirection of effort as conditions change in an

emergency. The radio also serves as a backup communications system where other systems, such as telephones or pager phones, have failed. Safety aspects of the system have been the consideration for the establishment of laws requiring two-way radio communication. Personnel interviewed at the mines indicated that the radio reduces the probability of intersection collisions of rail and rubber tired vehicles. The radios allow communications between vehicles at intersections as well as allow warnings in the event of a runaway vehicle.

Some radio system users have installed leaky feeder cable to remote locations where a single person or small crew works. This allows these individuals to work in a complete contact with supervisors or other crews away from their immediate area. A simple call to these people by a supervisor confirms whether or not an unusual condition exists. The radio also allows the remote person to relay requests for assistance.

#### **4.9 Alternative Forms of Communications**

Question 3 in Section 1.1 deals with alternatives to leaky feeder communications. The capabilities of leaky feeder communications are actually those of mobile radio communications, the principal advantage of which is the freedom of movement without loss of communications. Leaky feeder is merely a scheme for increasing the effectiveness of mobile radio in an environment which would otherwise severely limit range. Other schemes may exist.

An alternative to leaky feeders is the trolley wire carrier current system. It provides continuous communications to moving trains or vehicles through either a trolley wire or a special dedicated single conductor line. Conventional trolley wire systems are limited to communications between dispatcher and vehicle. Improved wireless systems available from major suppliers may make vehicle-to-vehicle communications feasible. However, the relatively large (typically 42-inch) coupling loops required for wireless trolley phones may limit the development of convenient personal portable units for use with carrier current systems.

The only true alternative to leaky feeder communications would be another means for enhancing radio propagation in underground mine tunnels, facilitating the use of mobile radio. No such alternative is currently known to be in commercial use, though the possibility of its development is not ruled out. For example, a U.S. Bureau of Mines sponsored system using passive reflectors to enhance propagation in a room and pillar mine is currently being evaluated in Black River Mine in Kentucky.

## 5.0 RECOMMENDATIONS

### 5.1 For Mine Owners and Operators Considering the Use of Underground Radio Communications

(1) *Radio systems require planning.* Management should acquire information on both the capabilities and limitations of radio systems from suppliers and from other mines with operating systems. If possible, a responsible representative of management should visit a mine already equipped and personally observe operations. Before proceeding with procurement, management should have prepared a performance specification defining exactly what the system is to include and what it is expected to do. This document can be prepared either by a technically qualified in-house staff member or by an outside consultant, but should not be left up to a potential supplier. Subsequently, the document can serve as a basis for procurement and installation. Incorporated into the installation contract, it will provide a reference against which actual performance can be compared.

(2) *Radio systems require management.* Without an individual *in a management position* pushing for and overseeing the radio system it is doomed to failure. In systems observed where the performance was exceptional, there was always an individual who felt that he was responsible for the system and who had an interest in its best performance. Without a person of this type on the staff or with this responsibility it is unlikely that a highly complex and technical system will be able to meet the demands of a harsh and abusive mine environment. Further, all leaky feeder communications system users should have an in-house radio technician or an engineer familiar with radio systems. While an in-house maintenance and repair capability is desirable, it is often economically not feasible. In such a case it should be a requirement that some management level personnel in the organization have a radio background or the necessary knowledge to properly oversee outside contract personnel. Without this, performance will suffer and maintenance expense is likely to run higher than necessary.

(3) *Radio systems require maintenance.* In several instances, it was found that the maintenance function was left to mine electricians who did not fully understand the radio system and thus provided poor maintenance. It is crucial that the maintenance of the system be performed by radio technicians with a knowledge of mining and its unique environment. Systems with good in-house capability were without exception the best systems studied by the project team. Certain of the mines where a good in-house capability existed were able to make modifications to the radios to counter several of the maintenance problems described earlier. Frequency selection capabilities were removed, remote microphone capability eliminated, and the radios reduced to simply having an on and off switch with volume control. Several mines indicated that the less expensive and less complex portable radios provided the greatest reliability and performance.

(4) *Users of radio equipment require training.* All underground personnel including supervisors should be thoroughly trained in proper radio use, radio communication etiquette, and operational procedures. Without thorough training of the entire underground work force the radio will be severely limited. Every individual with access to the system should know how to use it, when to use it, and its potential value to him. Because many workers in the mining industry are skeptical of management goals, the system's benefits to them should be highlighted. This would increase the acceptance of the system and improve its reliability by a reduction in physical abuse. Many individuals do not understand the radio system and fear that they will look strange to their fellow workers if they show ignorance of its use. This feeling should be eliminated and the miners made to feel as comfortable using the radio as they would using paging phones or any other communication system. The training for all personnel underground should also include a review of the system components, what they do, and how much they cost. The need for this training was recognized at almost every mine visited yet little was being done to rectify the problem.

## 5.2 **For Bureau of Mines Sponsorship of Activities Leading Toward the Lowering of Cost or Increasing the Benefits of Leaky Feeder Cables in Underground Mining**

The recommendations that follow are a response to the fourth question listed in the beginning of this report. A lowering of cost does appear feasible as does an increase in benefits achievable with leaky feeder systems.

(1) *It is recommended that alternative cable designs be investigated with a view toward reducing cable costs.* The most expensive single item in leaky feeder systems is the cable. Many designs have, in fact, been studied and no investigation should be conducted without reference to the literature on this subject. Nonetheless, a would-be user has a very limited choice of commercially available and proven designs. The investigation should include comparative tests in a mine environment of various designs, including designs and techniques used in other countries.

(2) *It is recommended that some Bureau of Mines sponsored entity be established for the provision of training and the exchange of information relating to communications and perhaps other mining technology.* In a recent report by John Short and Associates<sup>(23)</sup> the creation for coal miners of an "extension service" patterned after the agricultural service now provided for farmers was recommended. Among the services the extension service would provide are guidance for training in mine productivity, safety and health and a means for the exchange of technology in the mining industry. This concept is endorsed with the proviso that the exchange of technology include radio communications technology, and that training include the operation and use of radio equipment.

(3) *It is recommended that support be given to the further development and improvement of bi-directional line-powered cable amplifiers (or in-line repeaters) for underground mines.* Equipment of this kind is being developed and is available from U.S. and foreign suppliers. Advantages to be achieved are the elimination of multiple base station repeaters and their interconnecting audio and power lines, the reduction of required base station RF power and the reduction of RF power required of mobile and portable transceiver units. Ruggedness, reliability, intrinsic safety, and reasonable cost should be prime objectives in the development effort. Another consideration should be the use of frequency bands, such as 800-1000 MHz, known to have good propagation characteristics in tunnels but which are not currently used in underground mines. Full advantage should be taken of the existing cable television technology (6 to 400 MHz) and European daisy chain repeater technology (mostly 68-88 MHz).

(4) *It is recommended that the development of prototype mobile and portable transceivers for underground use be undertaken.* In some mines surveyed extensive modifications to equipment designed for surface use had been made. In all mines the reliability of mobile and portable transceivers suffered in the mine environment. Emphasis should be placed on simplicity, ruggedness, and intrinsic safety. Units should be single-channel and contain an absolute minimum of controls and switches. Used with a system of in-line cable amplifiers the transceivers would require RF power outputs considerably less than one watt. The ultimate objective should be that no miner is ever out of voice contact. An ideal for a miner's portable might be the equivalent of a very rugged pocket pager with talk-back capability.

(5) *It is recommended that the Bureau of Mines sponsor the development of a "recommended practices" document for the design, installation and operation of underground leaky feeder systems.* The mine survey revealed a wide variability in the installation and use of leaky feeder systems and uncovered a number of poor practices, many of which had already been found and corrected by the mines in question. For example, one mine which had employed aircraft control cable as a messenger (i.e., supporting cable) for leaky feeder was forced to replace it with stainless steel because of the corrosive mine environment. The document should cover possible uses and design configurations, installation practices for cable, installation practices for fixed and mobile radio equipment, recommended operating procedures and recommended maintenance procedures. The purpose of the document would be to provide guidance to mines which are considering the use of leaky feeder communications or which may be seeking to improve systems already installed.

## REFERENCES

1. Emslie, A.G., et. al., "Theory of the Propagation of UHF Radio Waves in Coal Mine Tunnels," *IEEE Transactions on Antennas and Propagation*, Vol. AP-23, No. 2, March 1975.
2. Deryck, Louis, "Natural Propagation of Electromagnetic Waves in Tunnels," *IEEE Transactions on Vehicular Technology*, VT-27, No. 3, August 1978.
3. Goddard, A.E., "Radio Propagation Measurements in Coal Mines at UHF and VLF," *Proc. Through-the-Earth Electromagnetics Workshop*, pp. 54-61 (Colorado School of Mines, Golden, Colorado, August 15-17, 1973).
4. Delogne, P. and Liegeois, R., "Radio Transmission Systems Recommended by Inix," International Electrical, Electronics Conference and Exposition, Toronto, Canada, September 29-October 1, 1975.
5. "Tune 550-Highway Radio Ahead," *Electronics*, September 1940, p. 32.
6. Halstead, Wm., "The Highway Advisory Radio Service," 28th IEEE Vehicular Technology Conference, Denver, Colorado, March 22-24, 1978.
7. Monk, N. and Winbigler, "Communication with Moving Trains in Tunnels," *IRE Trans. Vehicular Communications*, PGVC-7, pp. 21-28, December 1956.
8. Liegeois, Robt., "Communications par Radio dans les Tunnels," *Annales des Mines de Belgique*, No. 10, pp. 935-949, October 1974.
9. DeKeyser, R., "La Radio Sous Le Sol. Mesures et Realisations Pratiques avec le Systeme INIEX/Delogne," *Bulletine Technique "Mines et Carrieres"*, No. 135, pp. 5-20, January 1972.
10. Delogne, Paul and Safak, M., "Electromagnetic Theory of the Leaky Coaxial Cable," *The Radio and Electronic Engineer*, Vol. 45, No. 5, pp. 233-240, May 1975.
11. Delogne, Paul, "Les Systemes INIEX de Communication par Radio," *Annales des Mines de Belgique*, No. 10, pp. 951-962, October 1974.
12. Delogne, Paul, "Basic Mechanisms of Tunnel Propagation," *Radio Science*, Vol. 11, No. 4, pp. 295-303, April 1976.

13. Martin, D and Webster, R., "The Use of Radio in British Coal Mines," *Proc. Int. Conf. Radio: Roads, Tunnels, and Mines, Vol. 2 – Mines*, pp. 110-128, April 1974.
14. Martin, D.R.J., "A General Study of the Leaky Feeder Principle," *Radio Electronics Eng.*, Vol. 45, pp. 206-214, May 1975.
15. Martin, D.R.J., "Transferred Surface Currents in Braided Coaxial Cables," *Appl. Phys.*, Vol. 45, No. 8, pp. 3402-3406, August 1974.
16. Jones, R.W., "Performance of Slotted Cables for Radio Communication in Mines," *Proc. Colloquium on Leaky Feeder Radio Communication Systems* (Univ. of Surrey, Surrey, England) pp. 171-182, April 1974.
17. Martin, D. and Haining, R., "Leaky Feeder Radio Techniques for Mines and Tunnels," presented at the I.E.R.E. Land Mobile Radio Conference, Lancaster, England, September 1979.
18. Martin, D.J.R., "Radio Communication in Mines," *Mining Engineer*, pp. 275-282, December 77/January 78.
19. Bradburn, R.A. and Lagace, R.L., "UHF Section-to-Place Radio," Bureau of Mines Information Circular 8745, *Underground Mine Communications, Part 4, Section-to-Place*, 1977.
20. Bradburn, R.A. and Foulkes, J.D., "Longwall Mining Communications," Bureau of Mines Information Circular 8745, *Underground Mine Communications, Part 4 Section-to-Place*, 1977.
21. Lagace, et.al., "Leaky Coaxial Cable for Guided Wireless Communications in Mines," Final Report, Bureau of Mines Contract HO122026, pp. 3.1-3.24, January 1974, INTIS PB 235-079/AS.
22. Chufo, R.L., "Leaky-Feeder Ultrahigh-Frequency Radio," Bureau of Mines Information Circular 8744, *Underground Mine Communications, Part 3 Haulage Systems*, pp. 12-23, 1977.
23. "A Study to Determine the Manpower and Training Needs of the Coal Mining Industry," prepared by John Short and Associates for the Bureau of Mines, 1980 (NTIS PB 80-164742).