

NBSIR 74-378

**TIME AND AMPLITUDE STATISTICS
FOR ELECTROMAGNETIC NOISE IN MINES**

Motohisa Kanda

Electromagnetics Division
Institute for Basic Standards
National Bureau of Standards
Boulder, Colorado 80302

Prepared for:

U. S. Bureau of Mines
Pittsburgh Mining and Safety Research Center
4800 Forbes Avenue
Pittsburgh, Pennsylvania 15213



U.S. DEPARTMENT OF COMMERCE, Frederick B. Dent, Secretary

NATIONAL BUREAU OF STANDARDS, Richard W. Roberts, Director

CONTENTS

	<u>Page</u>
1.0 INTRODUCTION-----	1
2.0 MEASURANDS FOR TIME AND AMPLITUDE STATISTICS FOR EM NOISE IN MINES-----	2
2.1 Allan Variance Analysis (AVA)-----	2
2.2 Interpulse Spacing Distribution (ISD)-----	3
2.3 Pulse Duration Distribution (PDD)-----	4
2.4 Average Crossing Rate (ACR)-----	4
2.5 Amplitude Probability Distribution (APD)-----	4
3.0 NOISE MEASUREMENT TECHNIQUES-----	4
3.1 Measurement Instrumentation-----	4
3.1.1 Underground Recording System-----	4
3.1.2 Data Transcribing System-----	5
3.1.3 Data Processing System-----	5
3.2 Calibration-----	6
4.0 NOISE MEASUREMENT RESULTS-----	6
5.0 CONCLUSIONS-----	8
6.0 RECOMMENDATIONS-----	8
7.0 ACKNOWLEDGMENTS-----	9
8.0 REFERENCES-----	10

LIST OF FIGURES

	<u>Page</u>
Figure 1. Block diagram of underground recording system-----	11
Figure 2. Block diagram of transcribing system-----	12
Figure 3. Block diagram of data processing system-----	13
Figure 4-a. AVA, 10 kHz, vertical component, 1.0 kHz predetection bandwidth, December 5, 1972, 11:25 a.m., Robena No. 4-----	14
Figure 4-b. ISD, 10 kHz, vertical component, 1.0 kHz predetection bandwidth, December 5, 1972, 11:25 a.m., Robena No. 4-----	15
Figure 4-c. PDD, 10 kHz, vertical component, 1.0 kHz predetection bandwidth, December 5, 1972, 11:25 a.m., Robena No. 4-----	16
Figure 4-d. ACR, 10 kHz, vertical component, 1.0 kHz predetection bandwidth, December 5, 1972, 11:25 a.m., Robena No. 4-----	17
Figure 4-e. APD, 10 kHz, vertical component, 1.0 kHz predetection bandwidth, December 5, 1972, 11:25 a.m., Robena No. 4-----	18
Figure 5-a. AVA, 70 kHz, vertical component, 1.0 kHz predetection bandwidth, December 5, 1972, 2:45 p.m., Robena No. 4-----	19
Figure 5-b. ISD, 70 kHz, vertical component, 1.0 kHz predetection bandwidth, December 5, 1972, 2:45 p.m., Robena No. 4-----	20
Figure 5-c. PDD, 70 kHz, vertical component, 1.0 kHz predetection bandwidth, December 5, 1972, 2:45 p.m., Robena No. 4-----	21
Figure 5-d. ACR, 70 kHz, vertical component, 1.0 kHz predetection bandwidth, December 5, 1972, 2:45 p.m., Robena No. 4-----	22
Figure 5-e. APD, 70 kHz, vertical component, 1.0 kHz predetection bandwidth, December 5, 1972, 2:45 p.m., Robena No. 4-----	23
Figure 6-a. AVA, 2 MHz, vertical component, 1.2 kHz predetection bandwidth, December 5, 1972, 2:35 p.m., Robena No. 4-----	24
Figure 6-b. ISD, 2 MHz, vertical component, 1.2 kHz predetection bandwidth, December 5, 1972, 2:35 p.m., Robena No. 4-----	25
Figure 6-c. PDD, 2 MHz, vertical component, 1.2 kHz predetection bandwidth, December 5, 1972, 2:35 p.m., Robena No. 4-----	26
Figure 6-d. ACR, 2 MHz, vertical component, 1.2 kHz predetection bandwidth, December 5, 1972, 2:35 p.m., Robena No. 4-----	27
Figure 6-e. APD, 2 MHz, vertical component, 1.2 kHz predetection bandwidth, December 5, 1972, 2:35 p.m., Robena No. 4-----	28
Figure 7-a. AVA, 1 MHz, vertical component, 1.2 kHz predetection bandwidth, April 24, 1973, 10:30 a.m., Grace Mine-----	29

LIST OF FIGURES (Continued)

	<u>Page</u>
Figure 7-b. ISD, 1 MHz, vertical component, 1.2 kHz predetection bandwidth, April 24, 1973, 10:30 a.m., Grace Mine-----	30
Figure 7-c. PDD, 1 MHz, vertical component, 1.2 kHz predetection bandwidth, April 24, 1973, 10:30 a.m., Grace Mine-----	31
Figure 7-d. ACR, 1 MHz, vertical component, 1.2 kHz predetection bandwidth, April 24, 1973, 10:30 a.m., Grace Mine-----	32
Figure 7-e. APD, 1 MHz, vertical component, 1.2 kHz predetection bandwidth, April 24, 1973, 10:30 a.m., Grace Mine-----	33
Figure 8-a. AVA, 1 MHz, vertical component, 1.2 kHz predetection bandwidth, April 10, 1973, 1:10 p.m., McElroy Mine-----	34
Figure 8-b. ISD, 1 MHz, vertical component, 1.2 kHz predetection bandwidth, April 10, 1973, 1:10 p.m., McElroy Mine-----	35
Figure 8-c. PDD, 1 MHz, vertical component, 1.2 kHz predetection bandwidth, April 10, 1973, 1:10 p.m., McElroy Mine-----	36
Figure 8-d. ACR, 1 MHz, vertical component, 1.0 kHz predetection bandwidth, April 10, 1973, 1:10 p.m., McElroy Mine-----	37
Figure 8-e. APD, 1 MHz, vertical component, 1.0 kHz predetection bandwidth, April 10, 1973, 1:10 p.m., McElroy Mine-----	38
Figure 9-a. AVA, 10 kHz, vertical component, 1.0 kHz predetection bandwidth, April 17, 1973, 11:40 a.m., Itmann No. 3-----	39
Figure 9-b. ISD, 10 kHz, vertical component, 1.0 kHz predetection bandwidth, April 17, 1973, 11:40 a.m., Itmann No. 3-----	40
Figure 9-c. PDD, 10 kHz, vertical component, 1.0 kHz predetection bandwidth, April 17, 1973, 11:40 a.m., Itmann No. 3-----	41
Figure 9-d. ACR, 10 kHz, vertical component, 1.0 kHz predetection bandwidth, April 17, 1973, 11:40 a.m., Itmann No. 3-----	42
Figure 9-e. APD, 10 kHz, vertical component, 1.0 kHz predetection bandwidth, April 17, 1973, 11:40 a.m., Itmann No. 3-----	43
Figure 10-a. AVA, 70 kHz, vertical component, 1.0 kHz predetection bandwidth, April 17, 1973, 12:50 p.m., Itmann No. 3-----	44
Figure 10-b. ISD, 70 kHz, vertical component, 1.0 kHz predetection bandwidth, April 17, 1973, 12:50 p.m., Itmann No. 3-----	45
Figure 10-c. PDD, 70 kHz, vertical component, 1.0 kHz predetection bandwidth, April 17, 1973, 12:50 p.m., Itmann No. 3-----	46
Figure 10-d. ACR, 70 kHz, vertical component, 1.0 kHz predetection bandwidth, April 17, 1973, 12:50 p.m., Itmann No. 3-----	47
Figure 10-e. APD, 70 kHz, vertical component, 1.0 kHz predetection bandwidth, April 17, 1973, 12:50 p.m., Itmann No. 3-----	48

LIST OF FIGURES (Continued)

	<u>Page</u>
Figure 11-a. AVA, 1 MHz, vertical component, 1.2 kHz predetection bandwidth, April 17, 1973, 12:20 p.m., Itmann No. 3-----	49
Figure 11-b. ISD, 1 MHz, vertical component, 1.2 kHz predetection bandwidth, April 17, 1973, 12:20 p.m., Itmann No. 3-----	50
Figure 11-c. PDD, 1 MHz, vertical component, 1.2 kHz predetection bandwidth, April 17, 1973, 12:20 p.m., Itmann No. 3-----	51
Figure 11-d. ACR, 1 MHz, vertical component, 1.2 kHz predetection bandwidth, April 17, 1973, 12:20 p.m., Itmann No. 3-----	52
Figure 11-e. APD, 1 MHz, vertical component, 1.2 kHz predetection bandwidth, April 17, 1973, 12:20 p.m., Itmann No. 3-----	53

TIME AND AMPLITUDE STATISTICS FOR ELECTROMAGNETIC NOISE IN MINES

Motohisa Kanda

Abstract

The time and amplitude statistics necessary to adequately describe electromagnetic (EM) noise in mines are illustrated through computer software techniques. They are 1) Allan Variance Analyses (AVA), 2) Interpulse Spacing Distributions (ISD), 3) Pulse Duration Distributions (PDD), 4) Average Crossing Rates (ACR), and 5) Amplitude Probability Distributions (APD). These statistics are illustrated using data taken from a rather large store of raw analog data recorded in operational mines.

The curves generated for the illustrations characterize the noise environment in the mines from which the corresponding data were taken, and should aid in the design of reliable communication systems for such mines.

Key words: Allan variance analysis; amplitude probability distribution; amplitude statistics; average crossing rate; electromagnetic interference; electromagnetic noise; impulsive noise; interpulse spacing distribution; magnetic field strength; man-made noise; pulse duration distribution; time statistics.

1.0 Introduction

The need for reliable communication systems in mines is a long-standing problem. For emergency use when all the power in a mine is cut off the residual electromagnetic (EM) noise is not a problem. However, if a communication system were designed for emergency use only, it would have two serious drawbacks. First, it would not be ready for use in an emergency; second, it would not be of any value during normal operations. Therefore, the Bureau of Mines decided to design communication systems that could be used for both emergency and normal operational conditions.

During normal operation of a mine, the machinery used creates a wide range of many types of intense electromagnetic interference (EMI), and therefore ambient EMI is a major limiting factor in the design of a communication system.

There are several EMI parameters that can be measured: magnetic field strength, H ; electric field strength, E ; conducted current, i , and voltage, v , between two conductors. Some measurements of each of these parameters were performed but only one parameter is discussed here, namely the magnetic field strength, H , the magnitude of the magnetic field vector [1]. Since there are a multitude of different sources that generate all the known types of noise, the resultant magnetic field strength noise vector is a function of its frequency, time, sensor orientation, and location. Small changes in these parameters can cause many tens of decibels variations in the measured field strength.

The purpose of this report is to describe and illustrate five time and amplitude statistics needed to describe the random variations of the EM noise in mines. These statistics of EM noise are the statistical descriptors of the noise process needed to design and evaluate a telecommunication systems that will operate in a noisy environment [2,3].

In section 2.0, these time and amplitude statistics used for the analysis of the EM noise measured in mines are described. Section 3.0 describes briefly the measurement instrumentation of an underground recording system, a data transcribing system, a data processing system, and their calibration procedures. Section 4.0 gives the results of the recorded data taken in the mines analyzed by these time and amplitude statistics of EM noise taken in four different mines. The conclusions are given in section 5.0. A recommendation for data processing into a statistical form is given in section 6.0.

2.0 Measurands for Time and Amplitude Statistics for EM Noise in Mines

EM noise generated in mines is generally a non-stationary, random process. Therefore, the most meaningful measurands for EM noise generated in mines are statistical ones. We have used five time and amplitude statistics in order to unravel the complexities included in the EM, man-made noise in mines. We feel that the following five measurands compose a necessary and sufficient set of statistics upon which intelligent communication system design decisions can be made. They are:

1. Allan Variance Analysis (AVA),
2. Interpulse Spacing Distribution (ISD),
3. Pulse Duration Distribution (PDD),
4. Average Crossing Rate (ACR), and
5. Amplitude Probability Distribution (APD).

These are discussed below in detail.

2.1 Allan Variance Analysis (AVA)

It is essential to know how much data to gather when dealing with statistical quantities. Therefore, in any measurement of a statistical phenomenon the minimum length of time over which the phenomenon is observed should be determined. Allan Variance Analysis (AVA) can be used to accomplish this determination. The basic idea to be discussed briefly below has been implemented often in the discussion of frequency stability [4,5,6], and is a special case (sample size two) of the more general Allan Variance discussed in the references.

A record of the phenomenon under consideration, $y(t)$, is divided into a number of equal time segments of length τ , and the average value of $y(t)$, y_k , of each segment is calculated by

$$y_k = \frac{1}{\tau} \int_{t_k}^{t_k + \tau} y(t) dt,$$

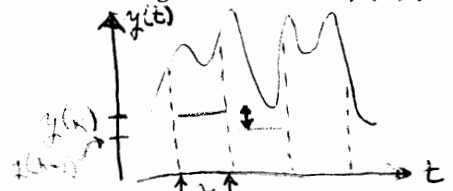

where y_k is the k^{th} segment average starting at time t_k . Next, the sample variance (sample size two), $\sigma_k^2(2, \tau)$, of successive averages is calculated. That is

$$\sigma_k^2(2, \tau) = \sum_{n=k}^{k+1} (y_n - \bar{y}_k)^2 = \frac{1}{2} (y_{k+1} - y_k)^2,$$

where

$$\bar{y}_k \equiv \frac{1}{2} \sum_{n=k}^{k+1} y_n$$

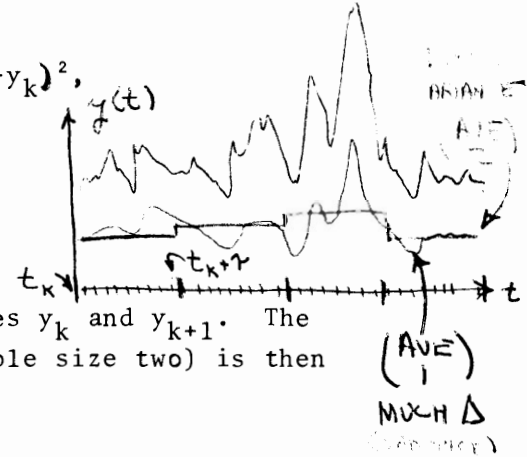

is the average of the two successive segment averages y_k and y_{k+1} . The Allan Variance, $\sigma_y^2(2, \tau)$, for this special case (sample size two) is then defined to be [4]

$$\sigma_y^2(2, \tau) \equiv \langle \sigma_k^2(2, \tau) \rangle,$$

where the brackets represent the average of $\sigma_k^2(2, \tau)$ over all pairs of successive y_k constructed from $y(t)$.

The preceding calculation is repeated for various values of averaging period, τ . For a given maximum allowable deviation in $y(t)$ the minimum averaging time can then be read off the graph. An example is given in section 4.0. A graph of the Allan Variance that does not decrease with τ indicates that the record, $y(t)$, from which $\sigma_y^2(2, \tau)$ was calculated needs to be longer. For A GIVEN $(t_k) - (t_k + \tau)$

The data are analyzed typically by computer via a program designed to compute the appropriate Allan variance. In the computer program $\log \sigma$ versus $\log \tau$ is plotted on microfilm along with the associated confidence levels [7].

2.2 Interpulse Spacing Distribution (ISD) [8]

The interpulse spacing distributions give the probability distribution for the spacing between successive pulses in the received noise process. These distributions are, of course, functions of the noise amplitude level. Seven distributions are given, each for a different noise amplitude level, covering the significant portion of the dynamic range of the noise process, approximately 45 dB.

2.3 Pulse Duration Distribution (PDD) [8]

The pulse duration distributions give the probability distribution for the pulse widths and are given in terms of the percentage of pulses which exceed various widths in seconds. As in section 2.2, distributions are given for each of the seven levels.

2.4 Average Crossing Rate (ACR) [8]

The average crossing rates present the average number of times the noise amplitude crosses various levels and is given as positive crossings per second versus noise amplitude level.

2.5 Amplitude Probability Distribution (APD)

The amplitude probability distributions are presented as a fraction of the time the envelope exceeds various levels. The APD is the most common statistical measurand required for analysis of the performance of communication systems. The details of the measurement of APD's and the resulting plots of data taken are given in previous literature [8,9,10,11,12].

3.0 Noise Measurement Techniques

3.1 Measurement Instrumentation

This section of the report describes the system used to measure the time and amplitude statistics of EM noise in mines. Parts of this system are described in detail in the previous literature [9]. Figures 1, 2, and 3 give block diagrams of the underground recording system, the data transcribing system, and the data processing system.

3.1.1 Underground Recording System

Figure 1 gives the block diagram of the system. The principal parameter measured is magnetic field strength. Electrostatically-shielded loop antennas are used to intercept the radiated magnetic field and to substantially discriminate against any electric-field component. For the frequency range between 10 kHz and 250 kHz, the loop antenna is a collapsible, single-turn diamond configuration with an area of about 0.7 square meters. For the frequency range between 150 kHz and 32 MHz, a single-turn, 38-cm diameter loop antenna is used with a balun. A switch on each balun allows the use of several impedance-matching networks (four for the low frequency case and eight for the high frequency case) which consist of transformers and coupling capacitors to give the desired match over the required frequency range. The outputs of the baluns are fed into commercially available, battery-powered, electromagnetic interference and field strength meters (hereafter referred to as EIFS meters).

In order to measure the time and amplitude statistics for the EM noise in mines, the AGC circuit of the EIFS meter is disabled. Since the gain of the receiver is now constant, the magnitude of the IF output is directly related to the band limited input noise signal magnitude.

A commercially available, battery-powered, portable, analog magnetic tape recorder is used for recording. Since the bandwidth of this portable tape recorder is limited to 50 kHz, the IF output from the EIFS meter is converted down from 455 kHz to 40 kHz using mixers. The tape speed chosen on record and on playback is 15 inches per second (ips). At this speed the portable tape recorder frequency response range is 100 Hz to 50 kHz at the ± 2 dB points in the direct recording mode. The input voltage range is adjusted to record the signal level between 10 millivolts and 1 volt rms with gain of 0 dB.

An external set of sealed, lead-acid batteries in an explosion-proof enclosure is used to drive the portable tape recorder. The current is limited by a solid-state, current-limiting circuit in series with a fuse. The power requirement is approximately 13 watts at a nominal 17.5 volts. This battery system provides power for about 8 hours of recording.

3.1.2 Data Transcribing System

The cumulative peak-to-peak flutter of the portable tape recorder is around 0.8 percent, whereas that of the laboratory tape recorder is around 0.4 percent. The time displacement error is perhaps more important, being microseconds for the laboratory tape recorder and milliseconds for the portable tape recorder. Therefore later, in the laboratory, the tapes are transcribed through a laboratory tape recorder whose servo system can take out the flutter and wow introduced by the portable tape recorder. Figure 2 gives the block diagram of the system. To give a reference time base, a stable 25-kHz signal is recorded on a separate track at the time the mine recordings are made. At playback time (after transcription) this signal is used to control the servo of the laboratory tape recorder.

3.1.3 Data Processing System

This portion of the measurement system is different from any previously used. The data processing system consists principally of the laboratory analog magnetic tape recorder as a playback unit, an amplifier, an envelope-detector receiver, a differential amplifier, an active low-pass filter, and a digitizer. Figure 3 gives the block diagram of the system. The amplifier is used primarily for impedance conversion between the output impedance of the laboratory tape recorder and the input impedance of the envelope-detector receiver. The 40-kHz output of the laboratory tape recorder is fed into an

envelope-detector receiver to extract the baseband noise. Since the detector output is coupled with a fixed, dc bias voltage ($\approx 6V$), the differential amplifier is used to take out this dc offset. The baseband noise is then fed into an active, low-pass filter to cut off the higher frequency components above 3 kHz before digitizing. For digitizing, 10 k samples per second with 4096 samples per record are used to produce 2500 records. This corresponds to about 17 minutes of real-time data.

A large digital computer is used to compute the time and amplitude statistics of the EM noise data recorded in the mines. The basic software was developed by L.R. Espeland and A.D. Spaulding of the Office of Telecommunications, Institute for Telecommunications Service [13], and was modified by the author. It is outside the scope of this report to describe the software in any detail, but the program and corresponding information will be available from the author upon request.

The 3-dB cw signal bandwidth of the whole measurement system, including the recording, transcribing, and data processing systems, is primarily determined by the data processing system. The predetection bandwidth of the measurements for the frequency range between 10 kHz and 250 kHz is 1.0 kHz, whereas the bandwidth for the frequency range between 250 kHz and 32 MHz is 1.2 kHz. The appropriate predetection bandwidths are indicated in each figure. The dynamic range of the whole measurement system is primarily limited by the magnetic tape recorder to about 45 dB.

3.2 Calibration

Calibration procedures similar to those followed in developing the APD's reported earlier are used [9,14]. For average crossing rates and amplitude probability distributions, the number of times a selected level is exceeded is determined for each of seven levels. These seven levels are approximately 2, 4, 10, 30, 100, 300, and 800 mV, and are calibrated using a cw signal each time the data are digitized. The estimated limits of error for EM noise measurements of time and amplitude statistics are ± 5 dB [9].

4.0 Noise Measurement Results

Data for time and amplitude statistical analysis of the EM noise were taken during actual operation of the following mines: 1) Robena No. 4 Coal Mine, Waynesburg, Pennsylvania; 2) Grace Hardrock Mine, Morgantown, Pennsylvania; 3) McElroy Coal Mine, Moundsville, West Virginia; and 4) Itmann No. 3 Coal Mine, Mullens, West Virginia. The detailed descriptions of these mines are given in the previous literature [9,10,11,12]. Although usually three orthogonal components of the magnetic field were measured at ten to twelve

frequencies in the range from 10 kHz to 32 MHz, time and amplitude statistical analysis for the vertical component of the magnetic field at 10 kHz, 70 kHz, and 1 MHz only are reported as illustrative examples in this report.

Five figures compromise a set where each of the five time and amplitude statistics is displayed; namely, Allan Variance Analysis (AVA), Interpulse Spacing Distribution (ISD), Pulse Duration Distribution (PDD), Average Crossing Rate (ACR), and Amplitude Probability Distribution (APD). Each of these sets of curves shown in figures 4 through 11 displays different measurements made at the four mines listed above. More comprehensive results of amplitude statistics alone are given in the previous literature [9,10,11,12].

The length of time for each measurement is 23 minutes, and 17 minutes of actual real time data is processed to obtain the time and amplitude statistics for the total noise in the mines. Each result of Allan Variance Analysis shows the validity for the choice of a seventeen minute measurement time. This seventeen minute time period for each measurement is adequate for covering the variations due to the local work cycle, at least for short (3-4 minute) cycles common in working sections of room-and-pillar mines. For example, figure 6-a shows the result of the Allan Variance Analysis (AVA) of EM noise at 2 MHz measured at the Robena No. 4 Coal Mine. The figure indicates that the 0.3 second averaged data have a standard deviation of 18% (~ 1.5 dB) from 17 minute averaged data, whereas the 5 minute averaged data have only a standard deviation of 5% (~ 0.4 dB) from 17 minute averaged data. Generally, when the noise generation mechanism is relatively stationary, the Allan Variance, $\sigma^2(2,\tau)$, tends to decrease as the averaging period, τ , is increased. However, there are cases when the Allan Variance, $\sigma^2(2,\tau)$, does increase with an increase of the averaging period, τ , as shown in figure 10-a (taken at 70 kHz at the Itmann No. 3 Coal Mine). It is believed that the work cycle for this longwall mine is much longer than several minutes, and 17 minutes of real time data is not sufficiently long enough to give statistically meaningful results for an entire work cycle.

For Average Crossing Rates (ACR) and Amplitude Probability Distributions (APD), the seven levels which are exceeded are approximately 2, 4, 10, 30, 100, 300, and 800 mV. For Interpulse Spacing Distributions (ISD), and Pulse Spacing Distributions (PSD), these are the levels at which a particular time interval is exceeded. These seven levels are calibrated using a cw signal each time the data was digitized. The time intervals that are exceeded are 0.2, 0.6, 2, 6, 20, 60, 200, 600, 2000, 6000, and 20,000 milliseconds. The interpretations of these other four time statistics are rather obvious. For example, in figure 4-b, the Interpulse Spacing Distribution (ISD) indicates that 55 percent of the time the interpulse spacing exceeds 2000 milliseconds at the EM noise level of 46 dB above one microampere per meter. Similarly, in figure 4-c, the Pulse Duration Distribution (PDD) indicates that 12 percent of

the time, the pulse widths exceed 200 milliseconds at the EM noise level of 2 dB above one microampere per meter. It should be noted that although the Interpulse Spacing Distributions (ISD) and the Pulse Duration Distributions (PDD) are complementary to each other, one cannot be obtained from the other. In figure 4-d, the Average Crossing Rate (ACR) characteristic indicates that the average positive crossings at an EM noise level of 20 dB above one microampere per meter are 300 crossings per second. Further, in figure 4-3, the Amplitude Probability Distribution (APD) indicates that 20 percent of the time, the EM noise exceeds 28 dB above one microampere per meter. These five time and amplitude statistics are essential to adequately describe EM noise in mines.

5.0 Conclusions

The time and amplitude statistics illustrated in this report are those necessary to adequately describe the time-dependent, EM noise in mines. They are 1) Allan Variance Analyses (AVA), 2) Interpulse Spacing Distributions (ISD), 3) Pulse Duration Distributions (PDD), 4) Average Crossing Rates (ACR), and 5) Amplitude Probability Distributions (APD). These statistics are illustrated using a rather large store of raw analog data recorded in operational mines through computer software techniques. The parameter assessed through this statistical approach is the magnetic field strength. The absolute values of the magnetic field strength analyzed are obtained with calibrated equipments. The frequency ranges of the magnetic field strengths cover from 10 kHz to 32 MHz. The length of time necessary to provide statistical validity was determined from the Allan Variance Analysis to be about 17 minutes for most of the mines measured. The curves generated for the illustrations characterize the noise environment in the mines from which the corresponding data were taken, and should aid in the design of reliable communication systems for such mines.

6.0 Recommendations

There are shortcomings in using these particular computer software techniques to obtain the statistics presented. First, cost is very high due to the number of man-hours needed to digitize and process the data. Second, if the length of time required to provide statistical validity were longer than 17 minutes, other practical limits would be encountered in use of the computer.

A significant reduction in both time and cost would be achieved if hardware was developed to present the data in the required statistics presented here without the serious limitations due to this software approach.

7.0 Acknowledgments

The research presented in this report was performed with the direction of J.W. Adams. The association with him was pleasant and inspiring, and his continuous encouragement and contributions are gratefully acknowledged.

Those also making significant contributions to this project were F.C. Cowley, T.B. Gray, and M.C. Candelaria of National Oceanic and Atmospheric Administration, and D.M. Sterns of the University of Colorado for data processing; A.D. Spaulding of the Institute for Telecommunication Sciences and W.W. Scott, Jr. of the National Bureau of Standards for much assistance in preparing this manuscript.

S.C. Foote and J.R. Becker provided typing assistance, while N.C. Tomoeda and J.S. Spencer provided drafting assistance.

8.0 References

- [1] The Institute of Electrical and Electronics Engineers, Inc., "IEEE Standard Dictionary of Electrical and Electronics Terms," IEEE Std. 100, 1972.
- [2] Crichlow, W.Q., et al., "Amplitude Probability Distributions for Atmospheric Radio Noise, NBS Monograph 23, Nov. 1960.
- [3] Thompson, W.J., III, "Bibliography of Ground Vehicle Communications and Control," AKWIC Index, Report No. DOT-TSC-UMTA-71-3, July 1971.
- [4] Allan, D.W., "Statistics of Atomic Frequency Standards," Proc. IEEE, Vol. 54, No. 2, pp. 221-230, Feb. 1966.
- [5] Barnes, J.A., et al., "Characterization of Frequency Stability," IEEE Trans. Instrum. & Meas., Vol. IM-20, No. 2, pp. 105-120, May 1971.
- [6] Shoaf, J. H., Halford, D., Risely, A.S., "Frequency Stability Specification and Measurement: High Frequency and Microwave Signals," NBS Technical Note 632, Jan. 1973.
- [7] Lesage, P. and Audoin, C., "Characterization of Frequency Stability: Uncertainty Due to the Finite Number of Measurements," IEEE Trans. Instrum. & Meas., Vol. IM-22, No. 2, pp. 157-161, June 1973.
- [8] Disney, R.T. and Spaulding, A.D., "Amplitude and Time Statistics of Atmospheric and Man-made Radio Noise," ESSA Technical Report ERL 150-ITS 98, Feb. 1970.
- [9] Bensema, W.D., Kanda, M., Adams, J.W., "Electromagnetic Noise in Robena No. 4 Coal Mine," NBS Technical Note 654, April 1974.
- [10] Adams, J.W., Bensema, W.D., Kanda, M., "Electromagnetic Noise in Grace Hardrock Mine," NBS Technical Note 657, June 1974.
- [11] Kanda, M., Adams, J.W., Bensema, W.D., "Electromagnetic Noise in McElroy Coal Mine," NBS Technical Note 658, June 1974.
- [12] Bensema, W.D., Kanda, M., Adams, J.W., "Electromagnetic Noise in Itmann No. 3 Coal Mine," NBS Technical Note 659, June 1974.
- [13] Espeland, L.R. and Spaulding, A.D., private communication.
- [14] Taggart, H.E. and Workman, J.L., "Calibration Principles and Procedures for Field Strength Meters (30 Hz to 1 GHz)," NBS Technical Note 370, March 1969.

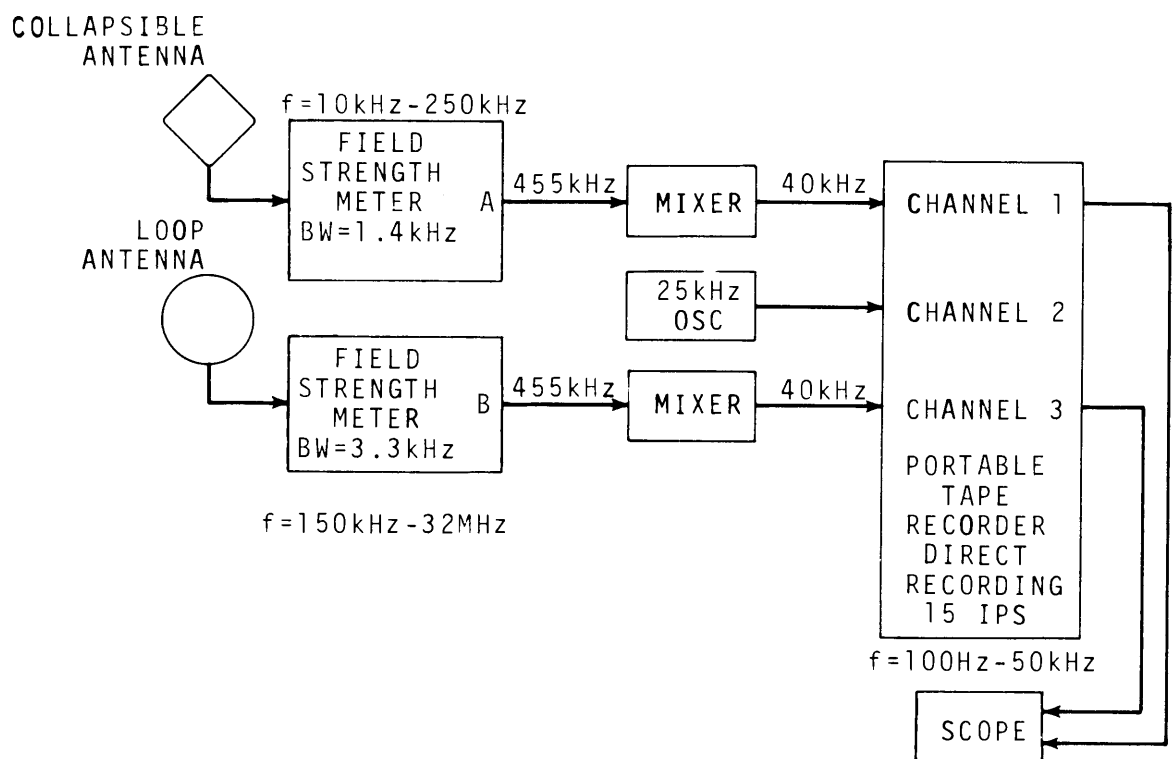

Figure 1. Block diagram of underground recording system.

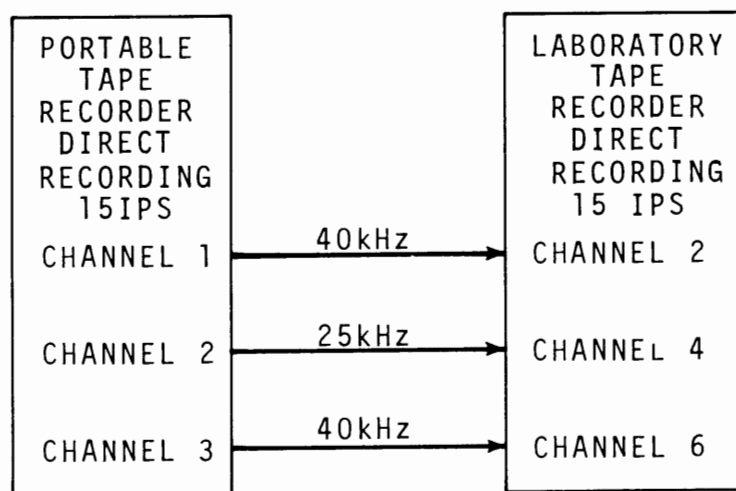

Figure 2. Block diagram of transcribing system.

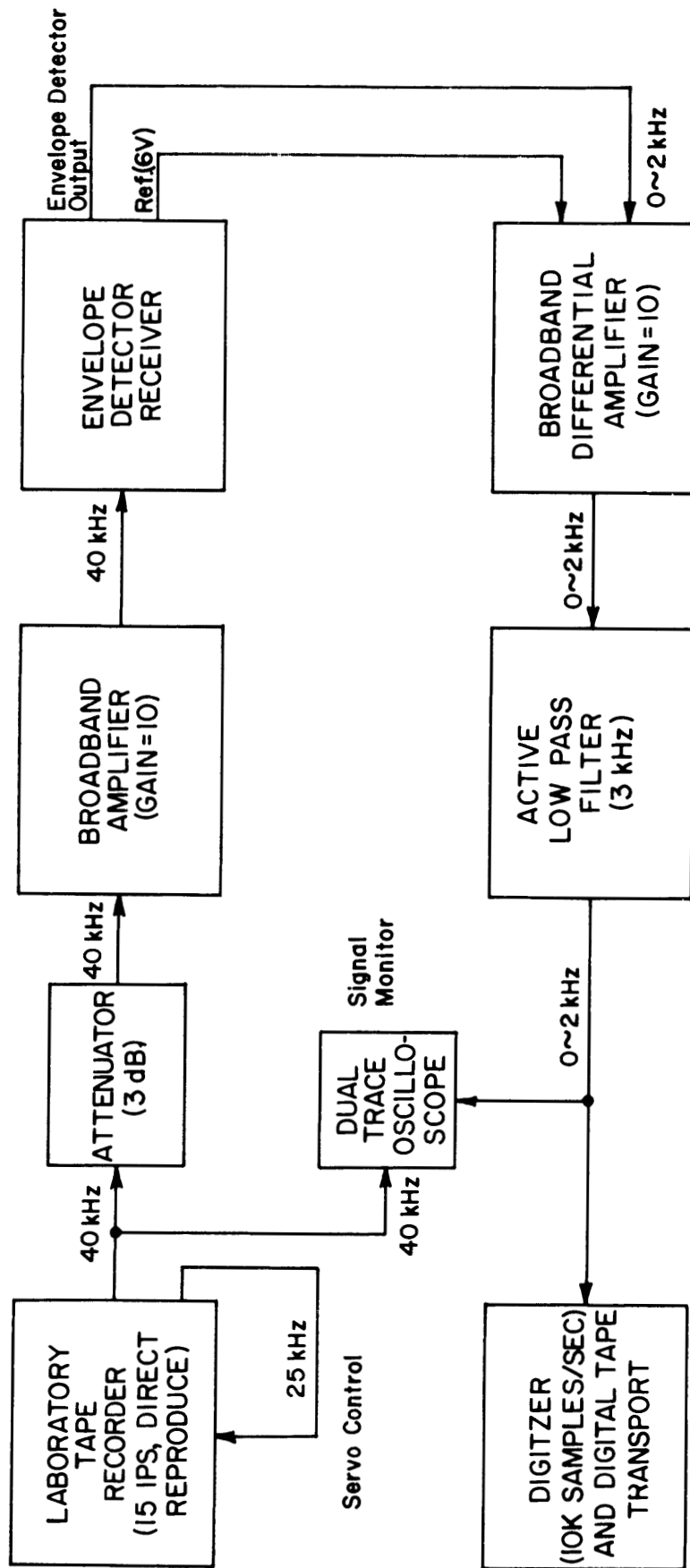

Figure 3. Block diagram of data processing system.

033114

TAU MIN. = 3.000 T/TAU = 1.000

MEAN VALUE - 1.5920+001

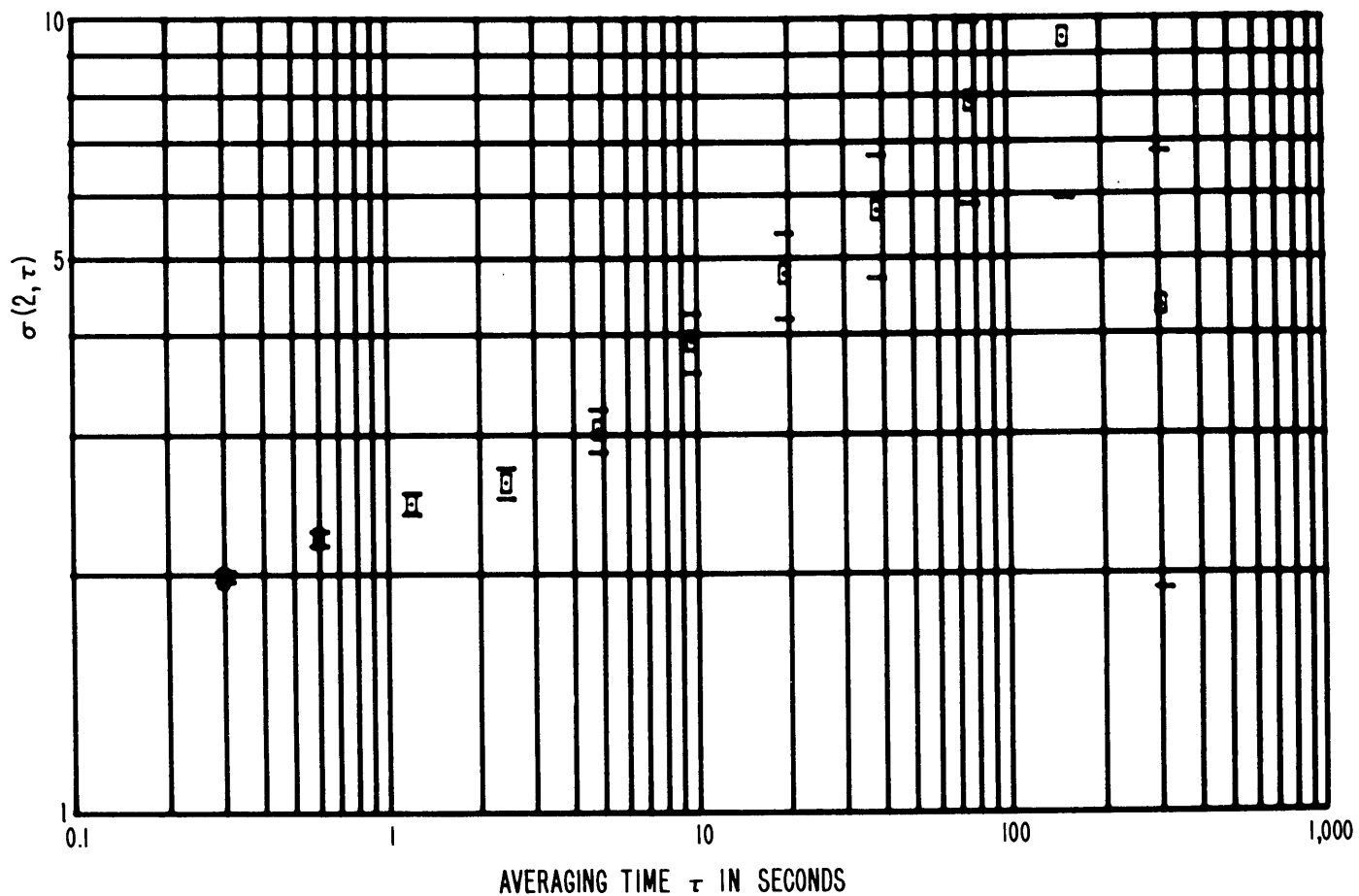
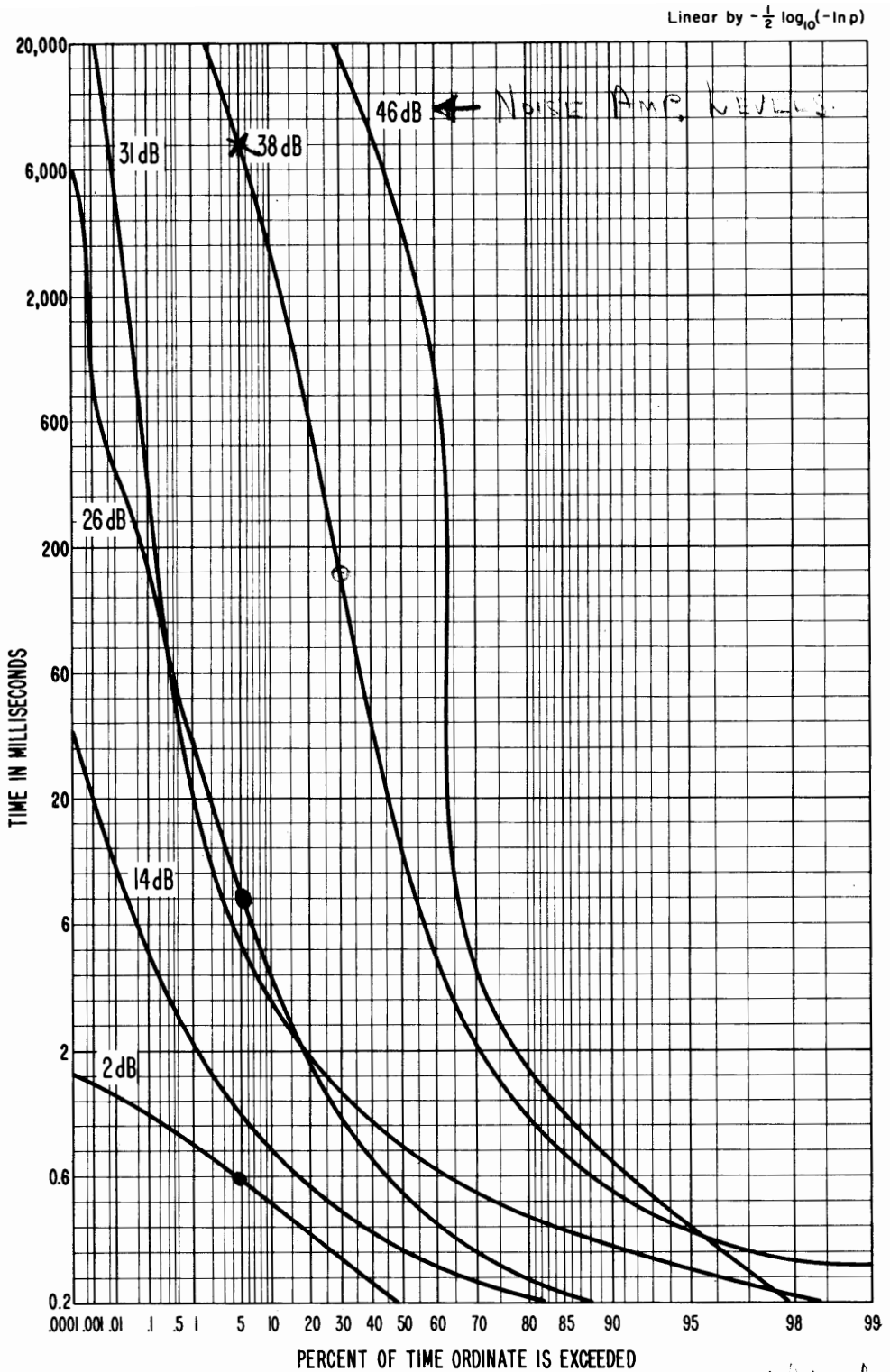

Figure 4-a. AVA, 10 kHz, vertical component, 1.0 kHz predetection bandwidth, December 5, 1972, 11:25 a.m., Robena No. 4.



- 5% of the time 2 dB noise pulses are separated by .6 sec (lots of 2 dB noise)
 - 5% of the time 26 dB " " " " " " 3 sec (not so much 26 dB noise)
- Figure 4-b. ISD, 10 kHz, vertical component, 1.0 kHz predetection bandwidth, December 5, 1972, 11:25 a.m., Robena No. 4.
- X 5% of the time 38 dB " " " " " " 8000 sec (38 dB is very rare!)
- > 35% " " " " " " 15 " " 180000

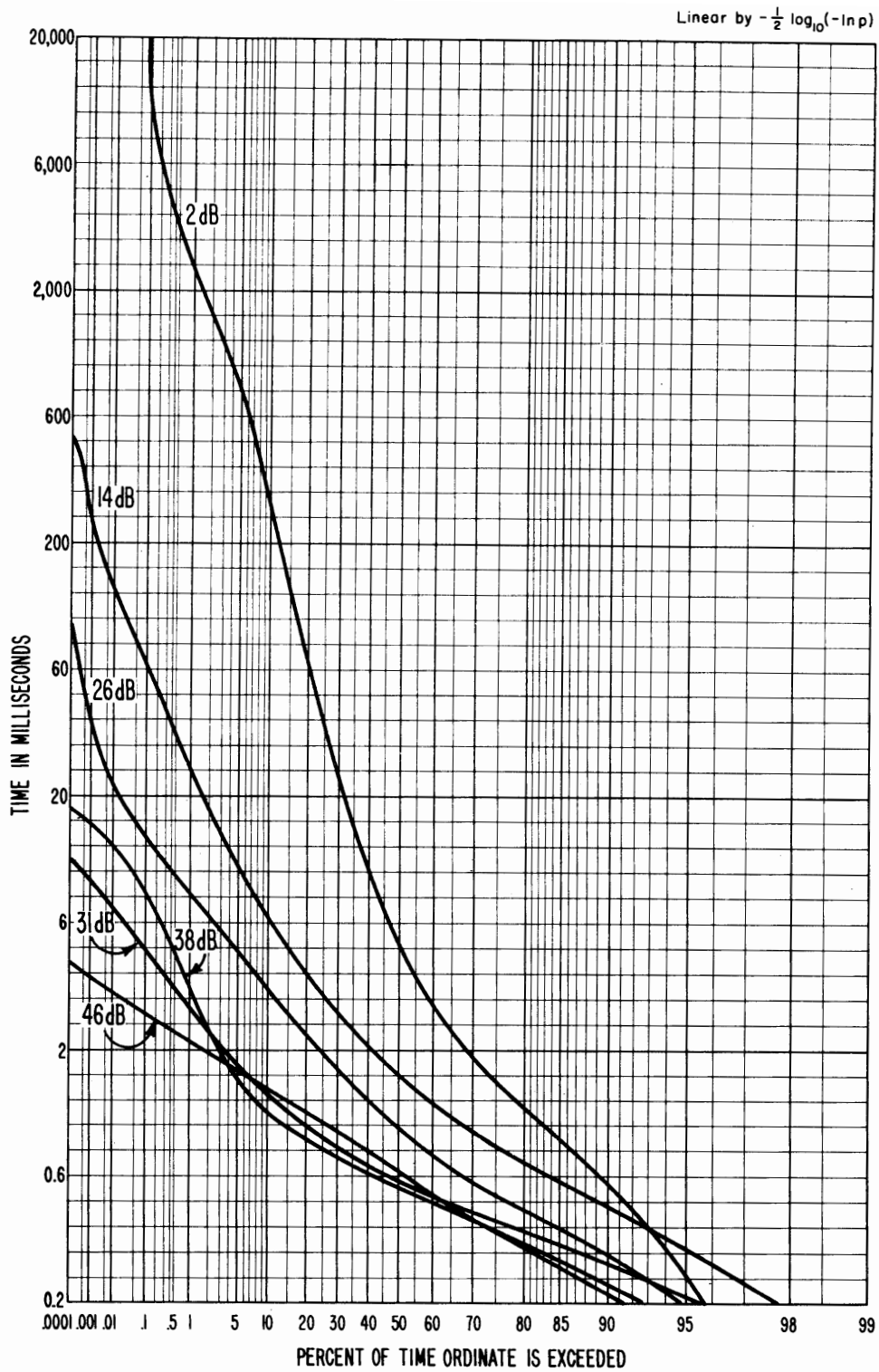

Figure 4-c. PPD, 10 kHz, vertical component, 1.0 kHz predetection bandwidth, December 5, 1972, 11:25 a.m., Robena No. 4.

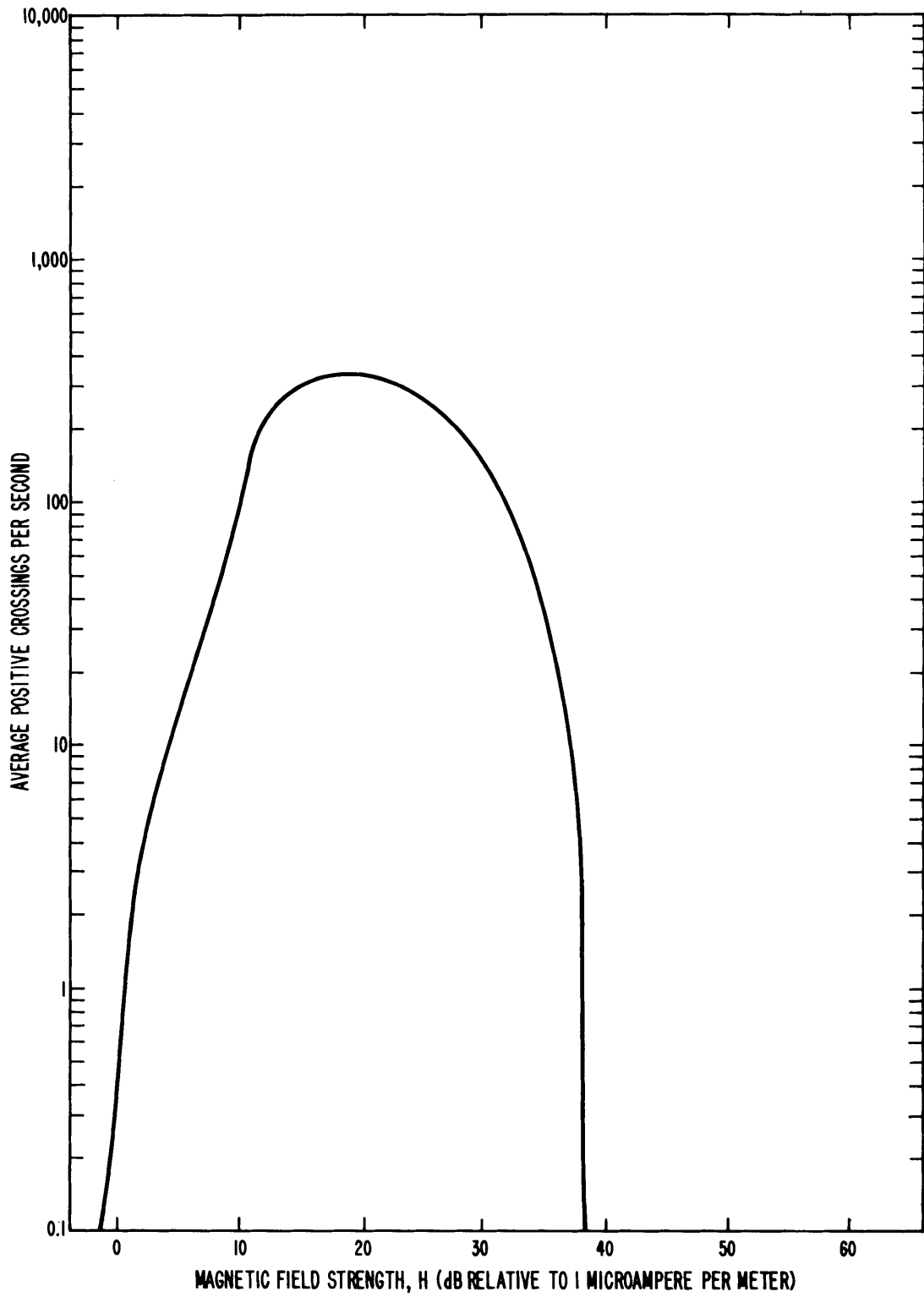

Figure 4-d. ACR, 10 kHz, vertical component, 1.0 kHz predetection bandwidth, December 5, 1972, 11:25 a.m., Robena No. 4.

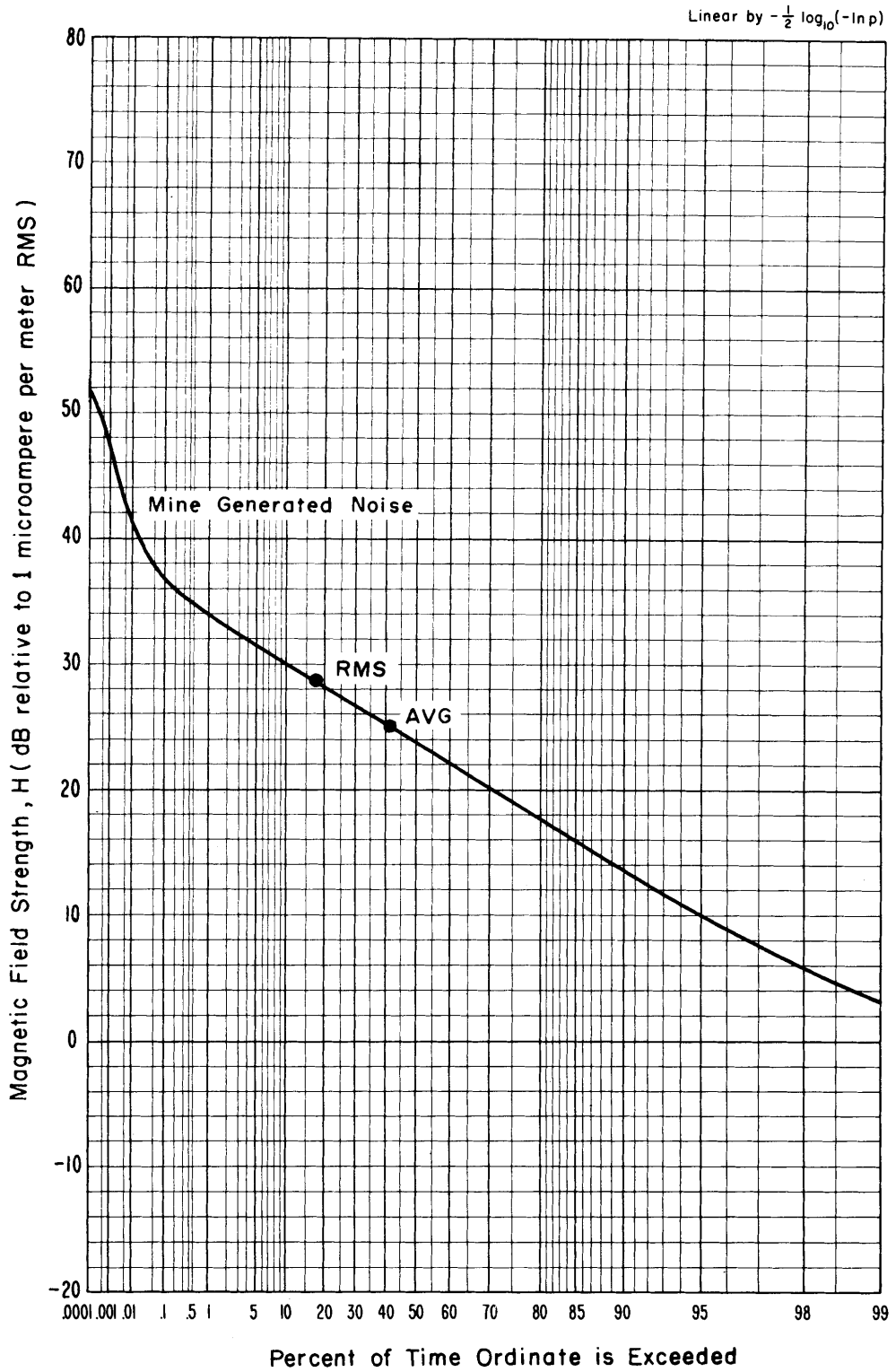

Figure 4-e. APD, 10 kHz, vertical component, 1.0 kHz predetection bandwidth, December 5, 1972, 11:25 a.m., Robena No. 4.

034114

TAU MIN. = 3.000 T/TAU = 1.0000

MEAN VALUE = 3.5882+001

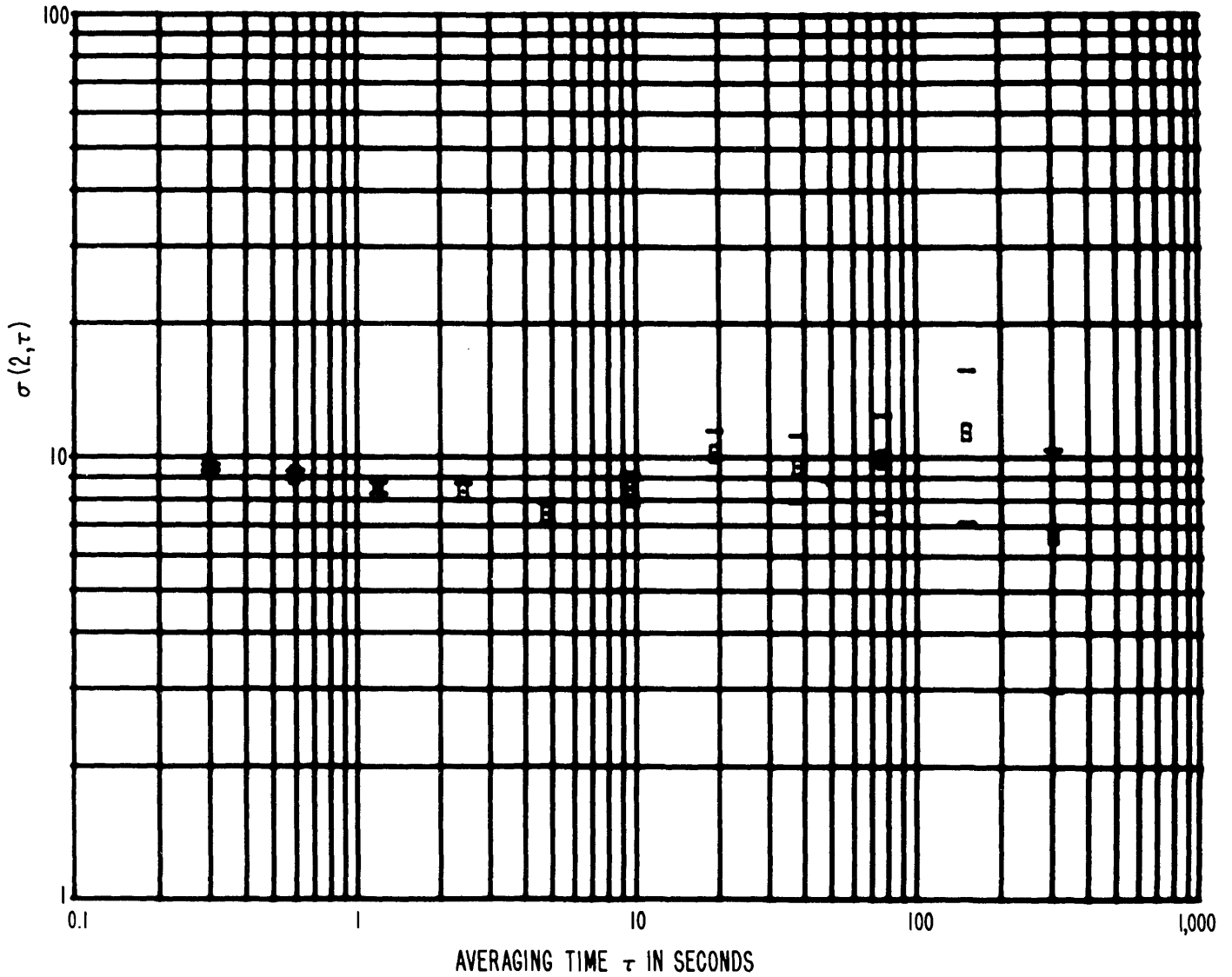

Figure 5-a. AVA, 70 kHz, vertical component, 1.0 kHz predetection bandwidth, December 5, 1972, 2:45 p.m., Robena No. 4.

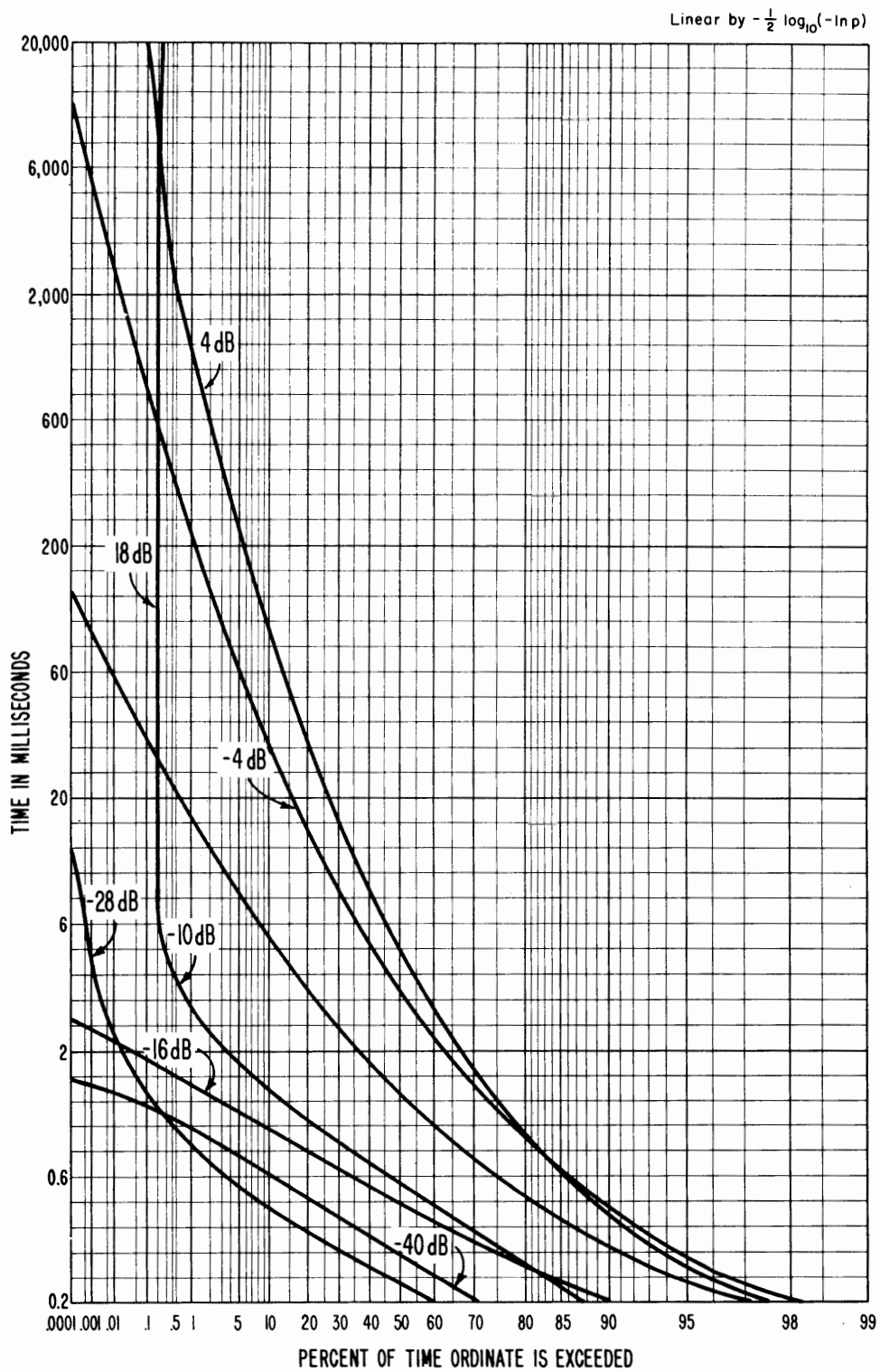

Figure 5-b. ISD, 70 kHz, vertical component, 1.0 kHz predetection bandwidth, December 5, 1972, 2:45 p.m., Robena No. 4.

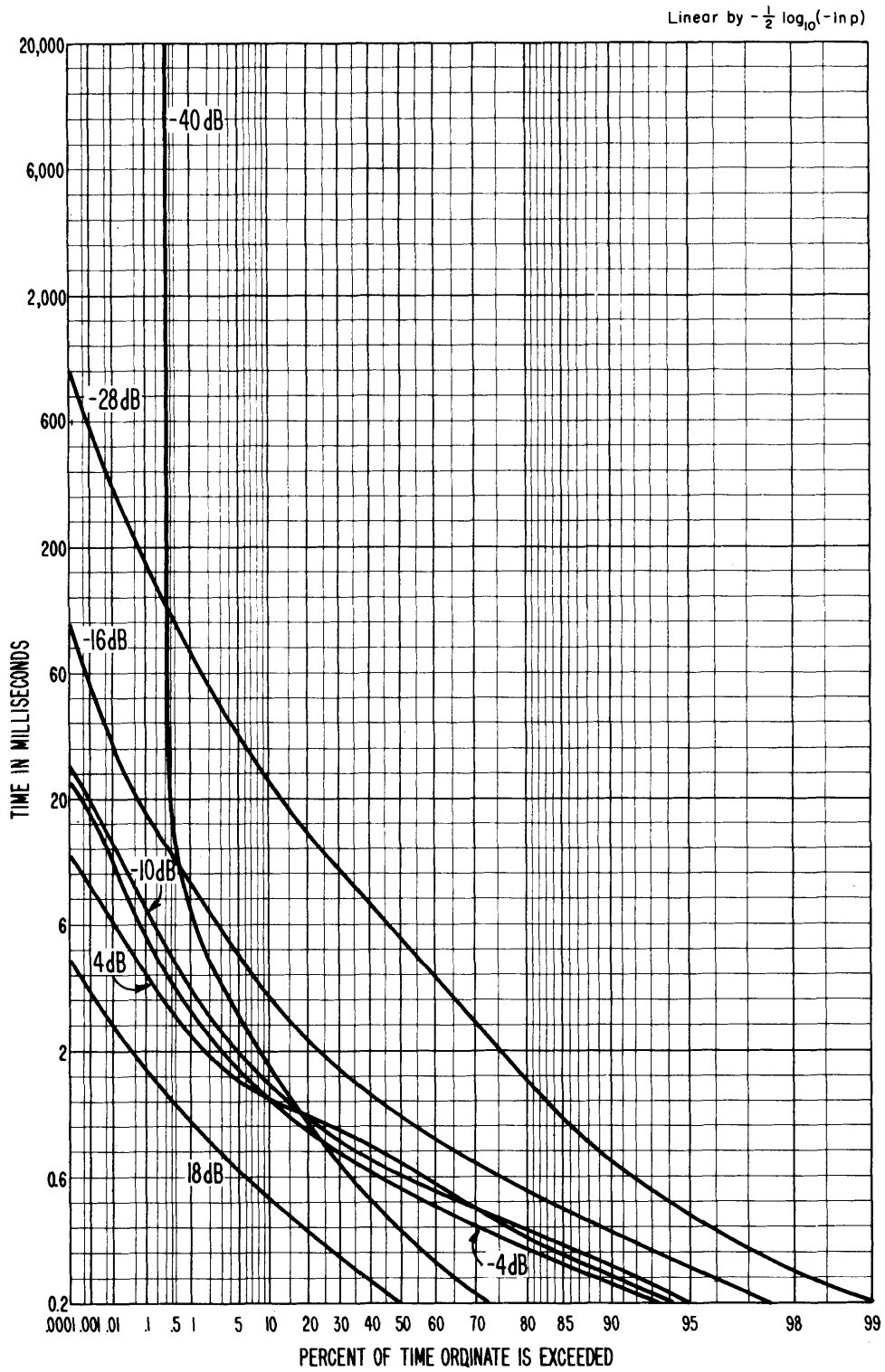

Figure 5-c. PDD, 70 kHz, vertical component, 1.0 kHz predetection bandwidth, December 5, 1972, 2:45 p.m., Robena No. 4.

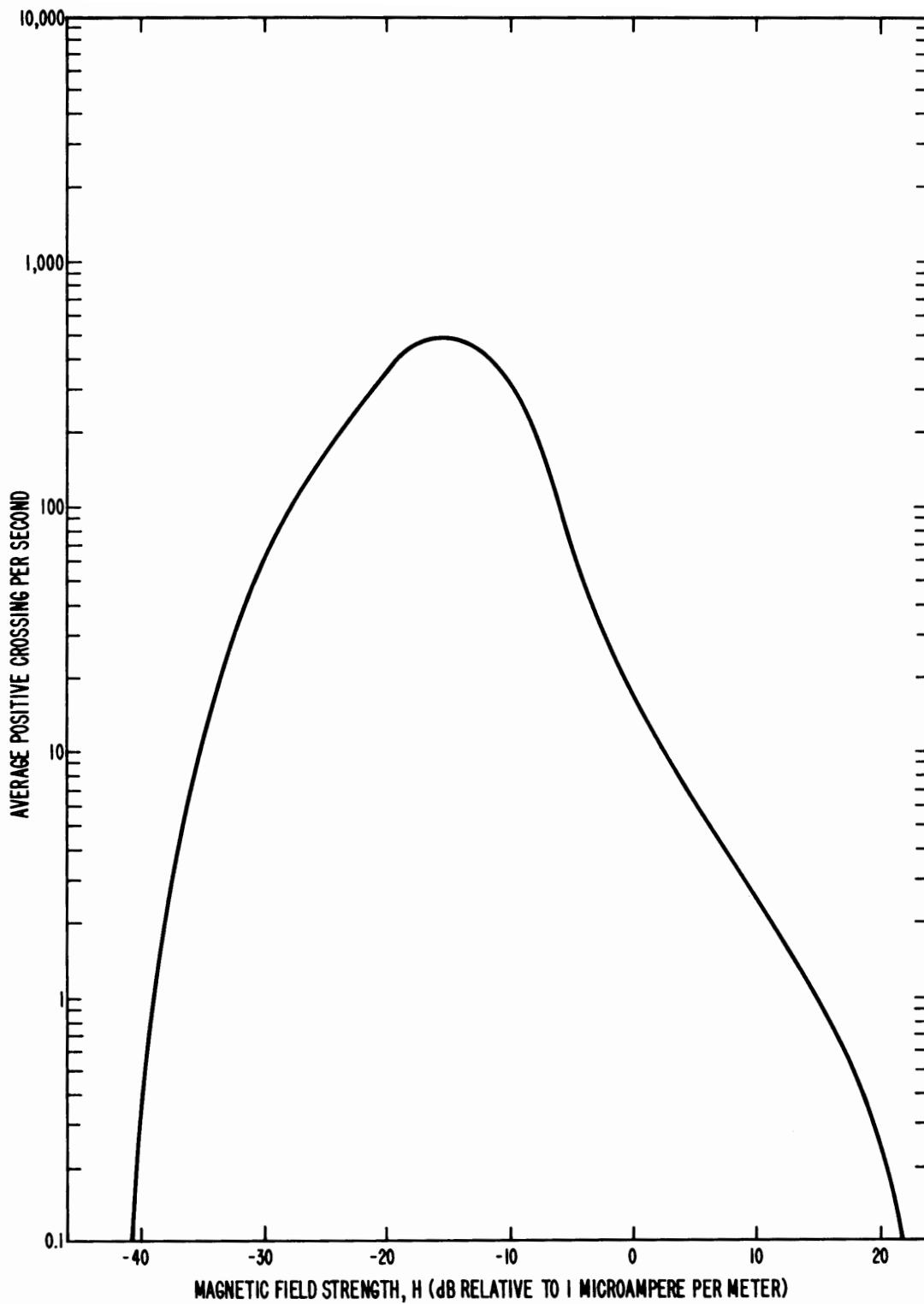

Figure 5-d. ACR, 70 kHz, vertical component, 1.0 kHz predetection bandwidth, December 5, 1972, 2:45 p.m., Robena No. 4.

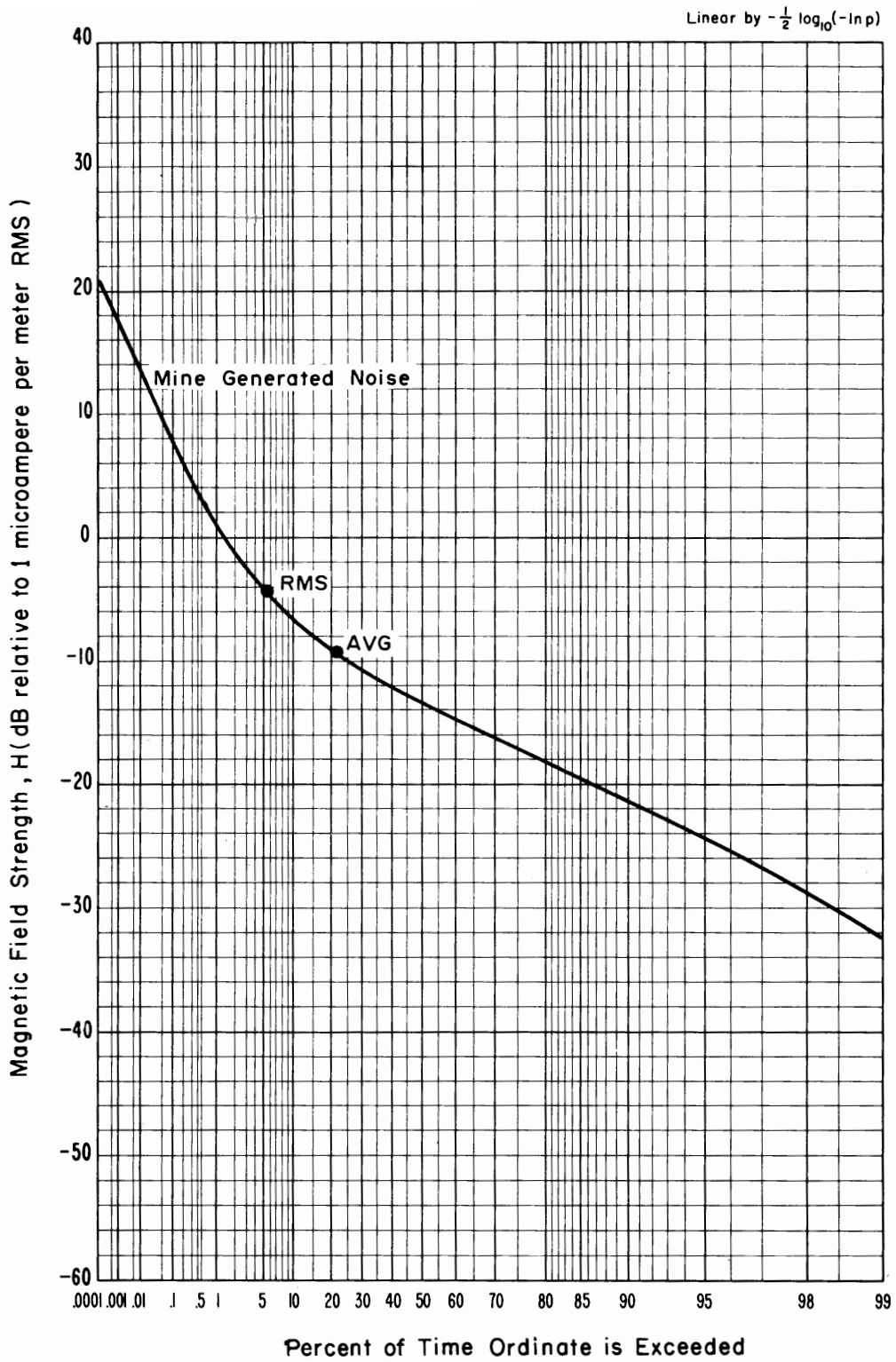

Figure 5-e. APD, 70 kHz, vertical component, 1.0 kHz predetection bandwidth, December 5, 1972, 2:45 p.m., Robena No. 4.

035114

TAU MIN. = 3.000 T/TAU = 1.0000

MEAN VALUE = 5.5330+001

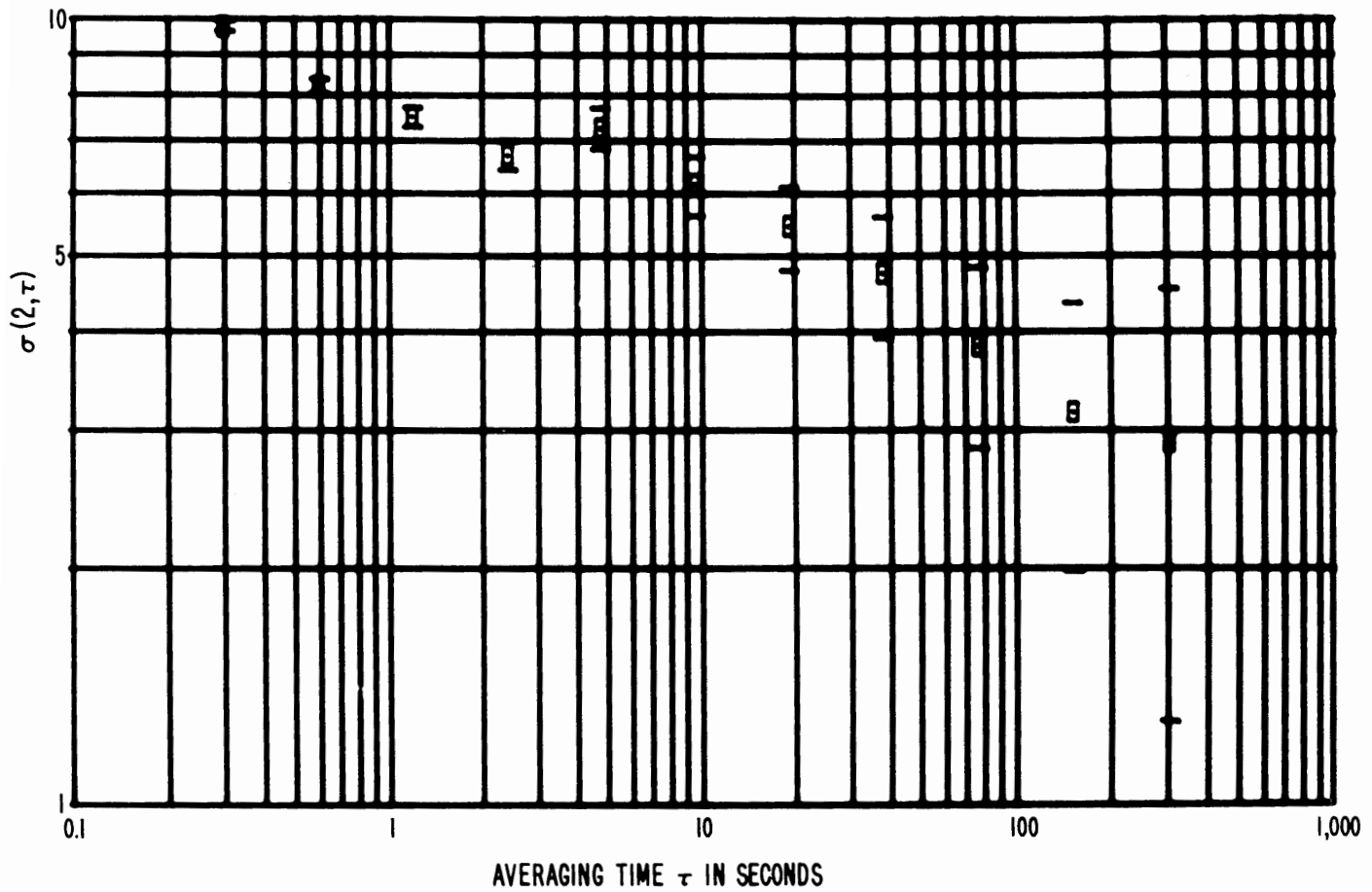

Figure 6-a. AVA, 2 MHz, vertical component, 1.2 kHz predetection bandwidth, December 5, 1972, 2:35 p.m., Robena No. 4.

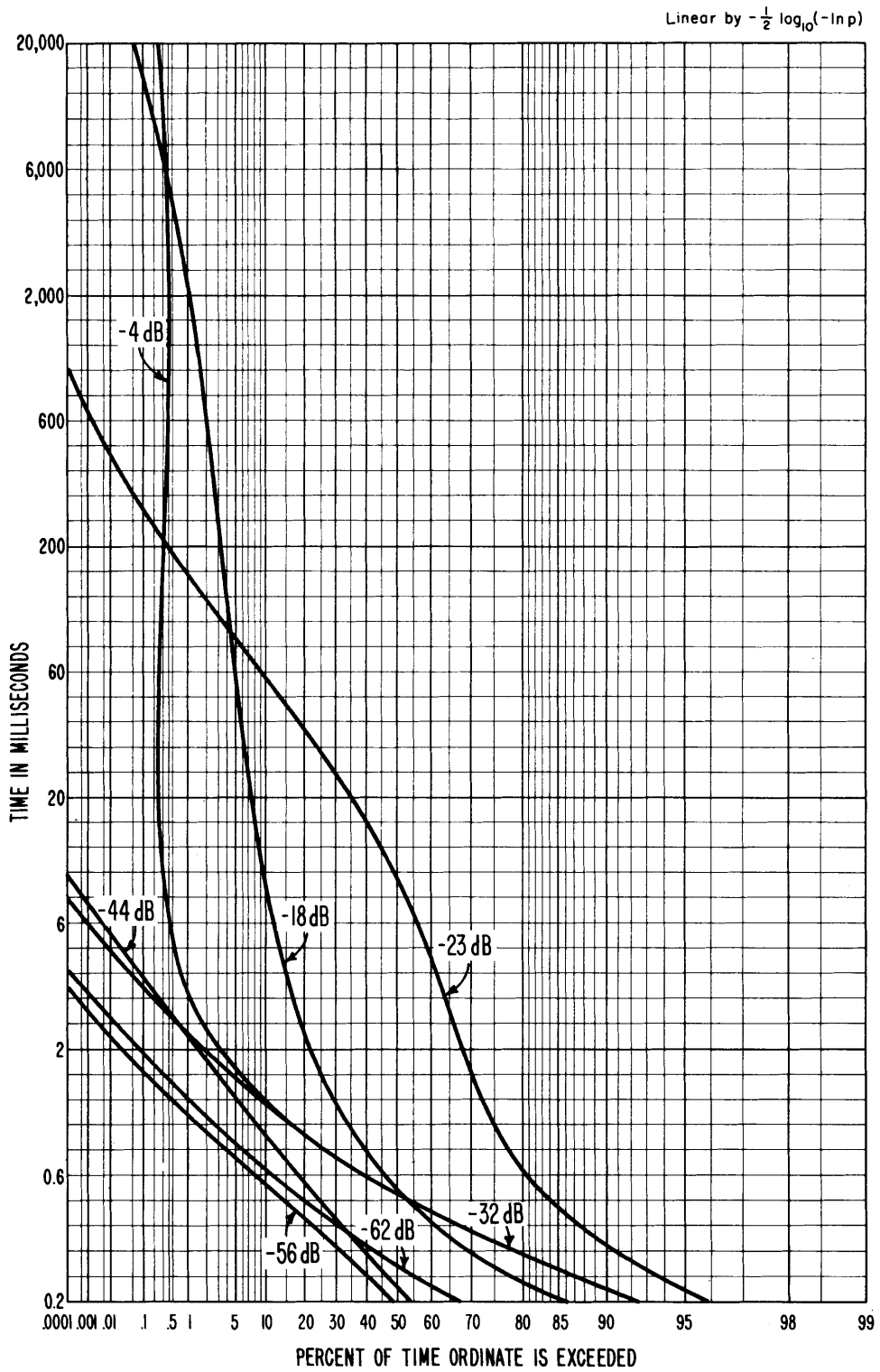

Figure 6-b. ISD, 2 MHz, vertical component, 1.2 kHz predetection bandwidth, December 5, 1972, 2:35 p.m., Robena No. 4.

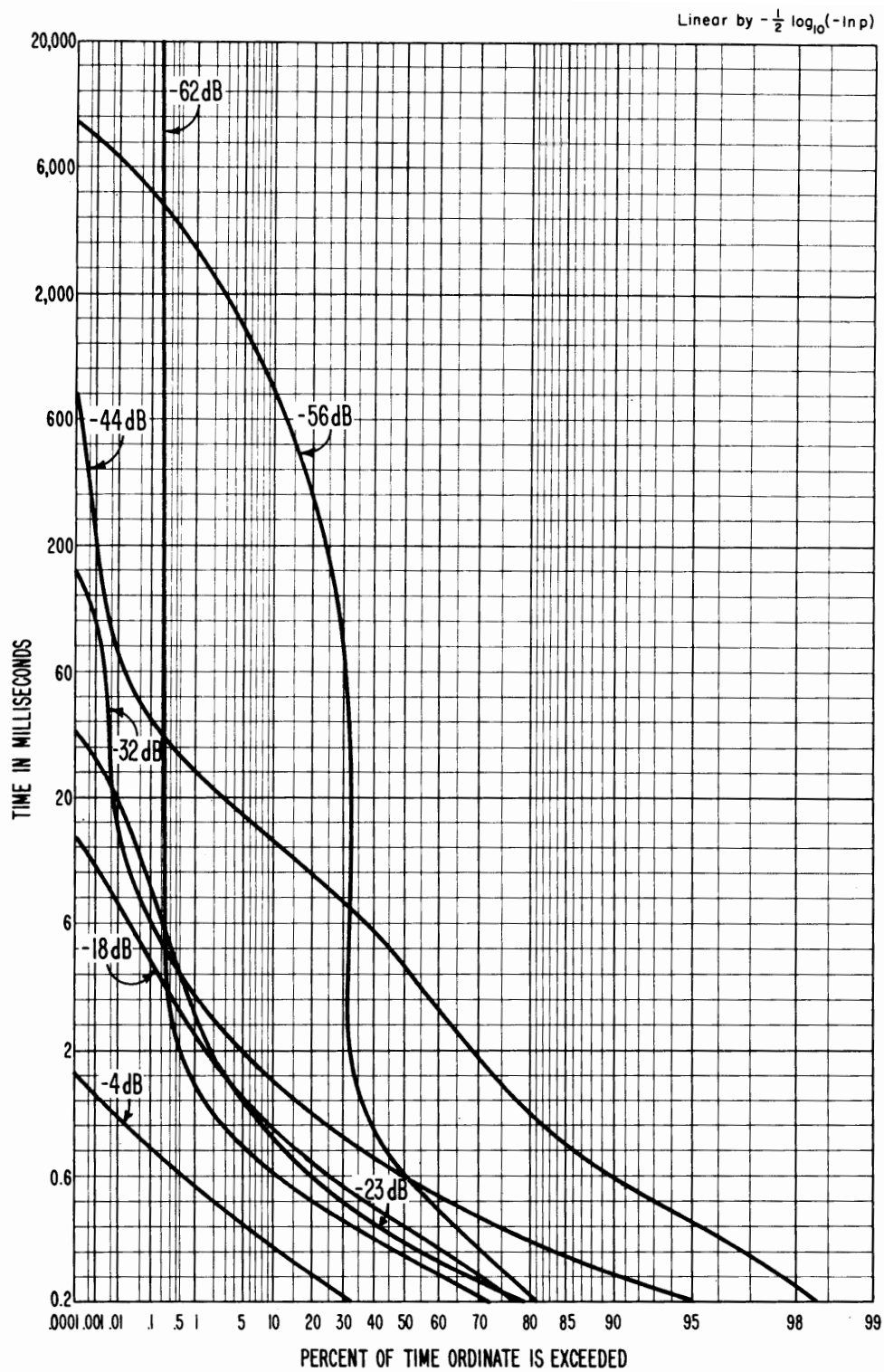

Figure 6-c. PDD, 2 MHz, vertical component, 1.2 kHz predetection bandwidth, December 5, 1972, 2:35 p.m., Robena No. 4.

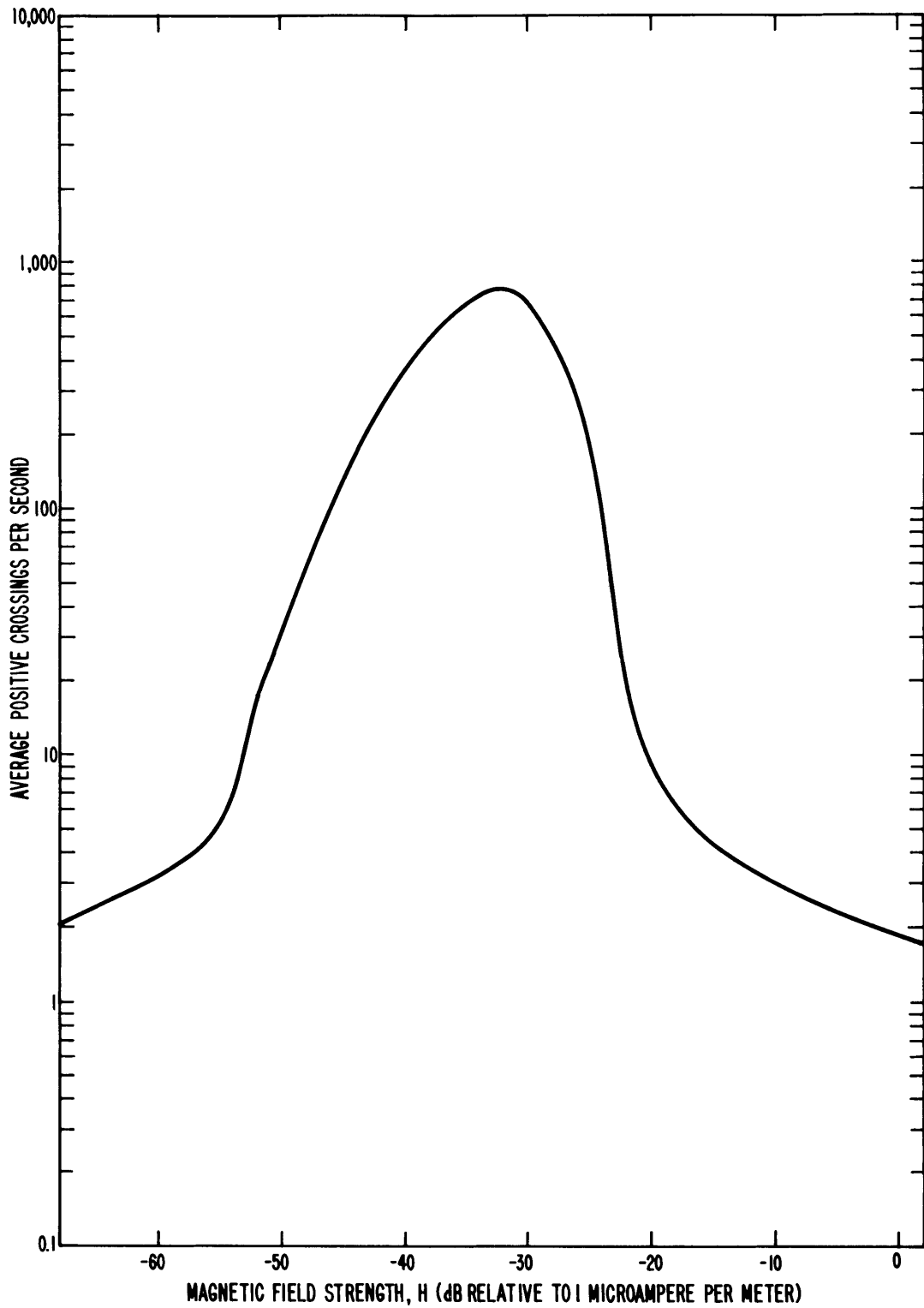

Figure 6-d. ACR, 2 MHz, vertical component, 1.2 kHz predetection bandwidth, December 5, 1972, 2:35 p.m., Robena No. 4.

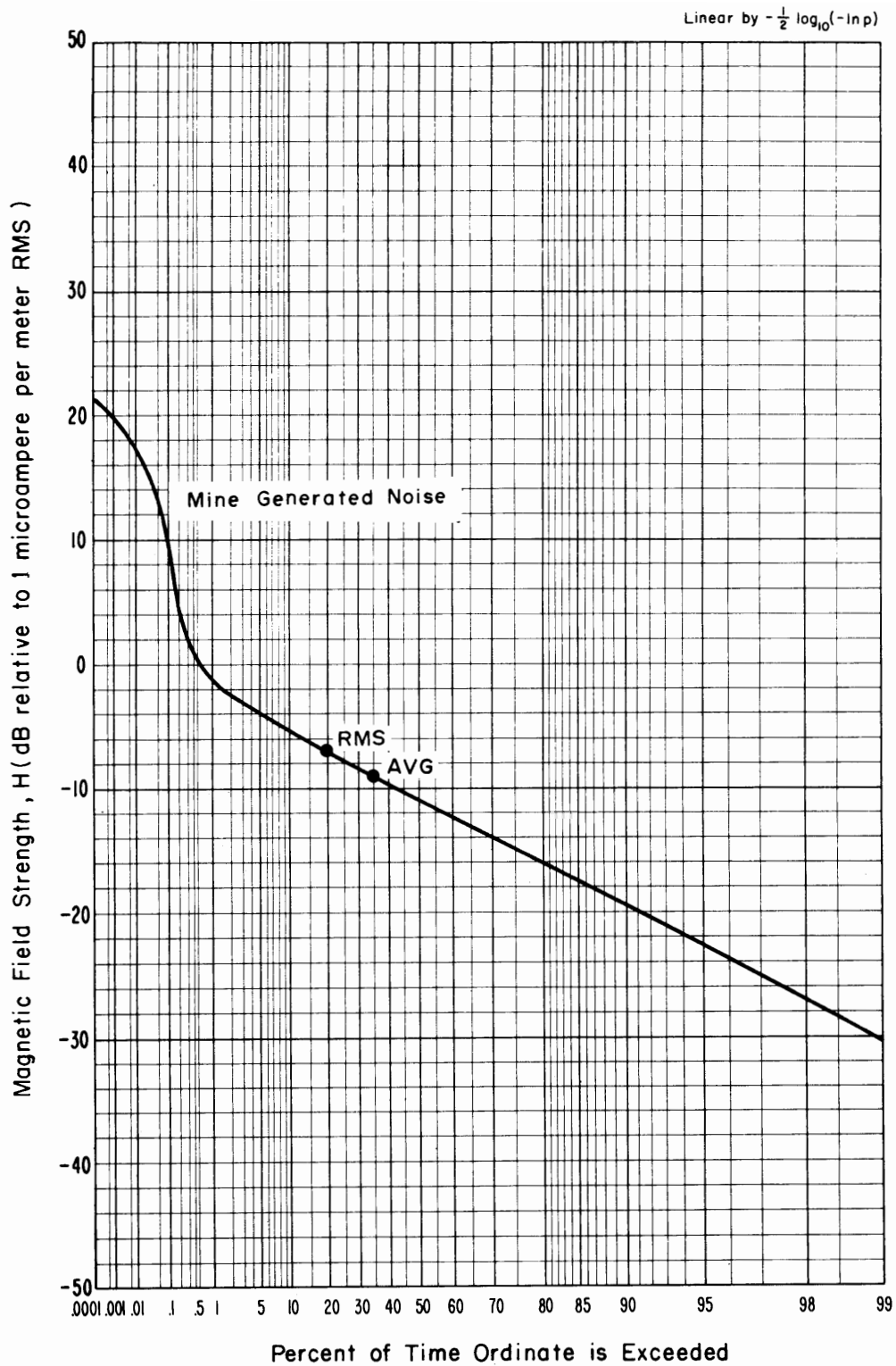

Figure 6-e. APD, 2 MHz, vertical component, 1.2 kHz predetection bandwidth, December 5, 1972, 2:35 p.m., Robena No. 4.

038114

TAU MIN. = 3.000 T/TAU = 1.0000

MEAN VALUE = 3.4767+001

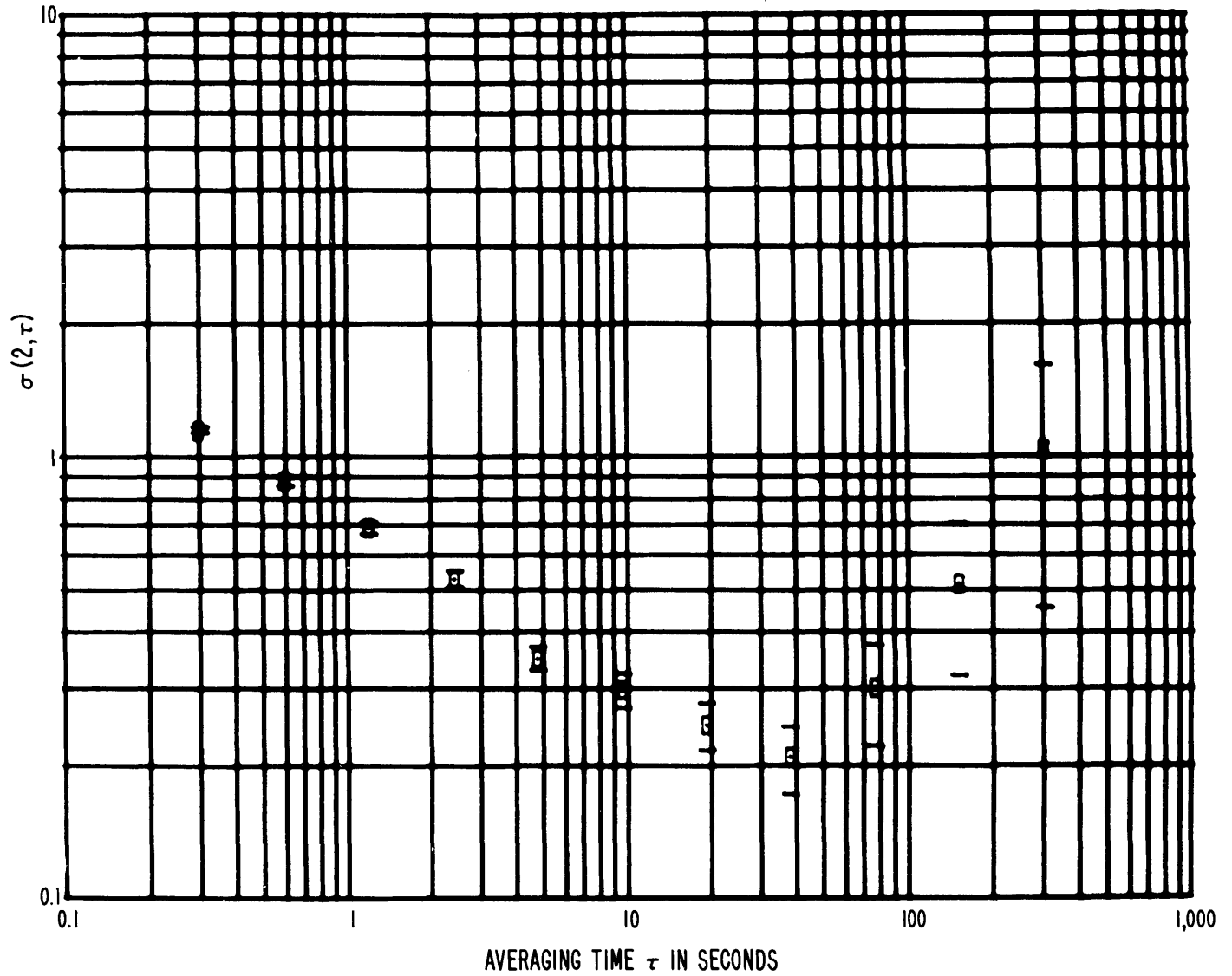

Figure 7-a. AVA, 1 MHz, vertical component, 1.2 kHz predetection bandwidth, April 24, 1973, 10:30 a.m., Grace Mine.

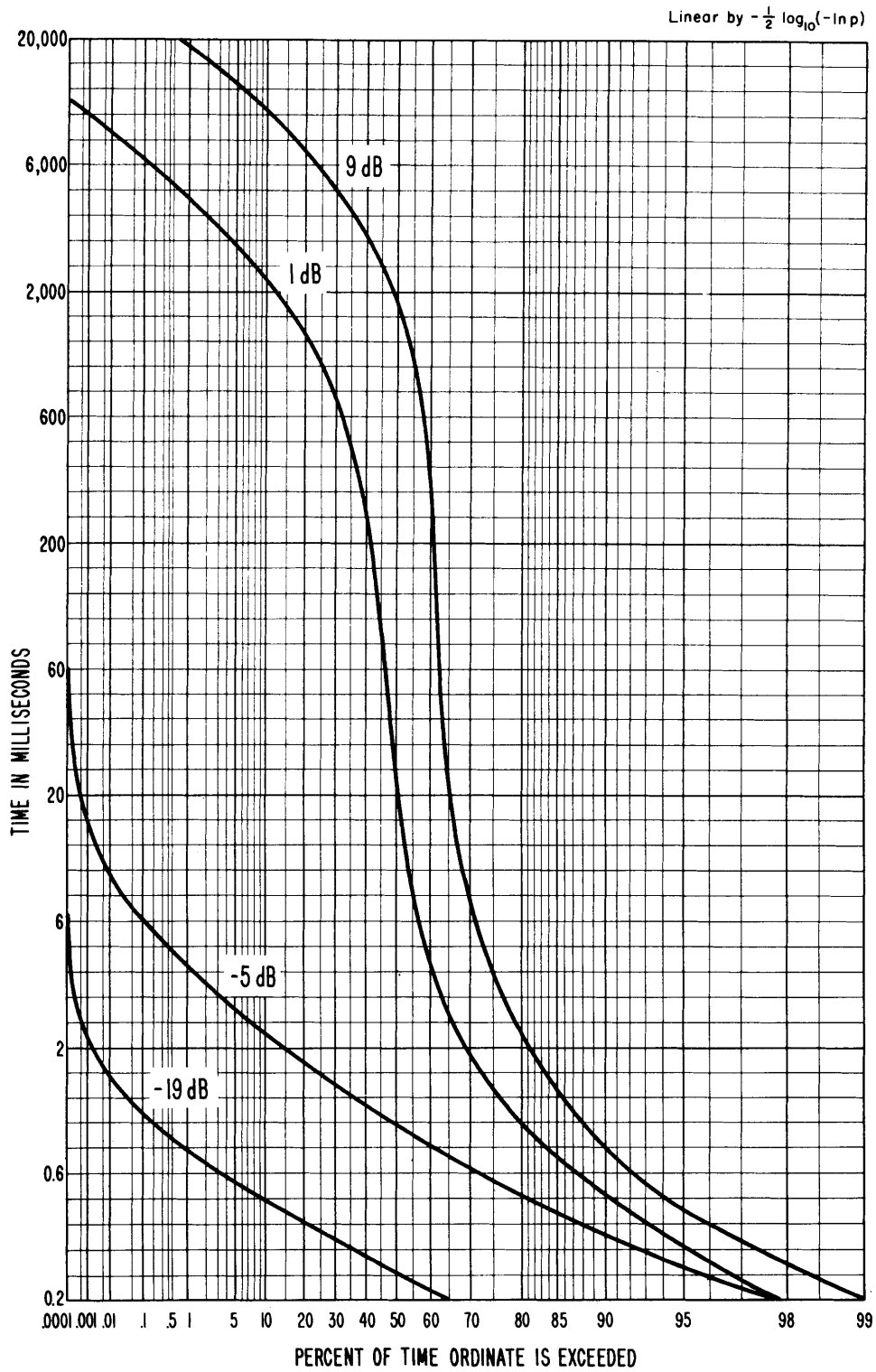

Figure 7-b. ISD 1 MHz, vertical component, 1.2 kHz predetection bandwidth, April 24, 1973, 10:30 a.m., Grace Mine.

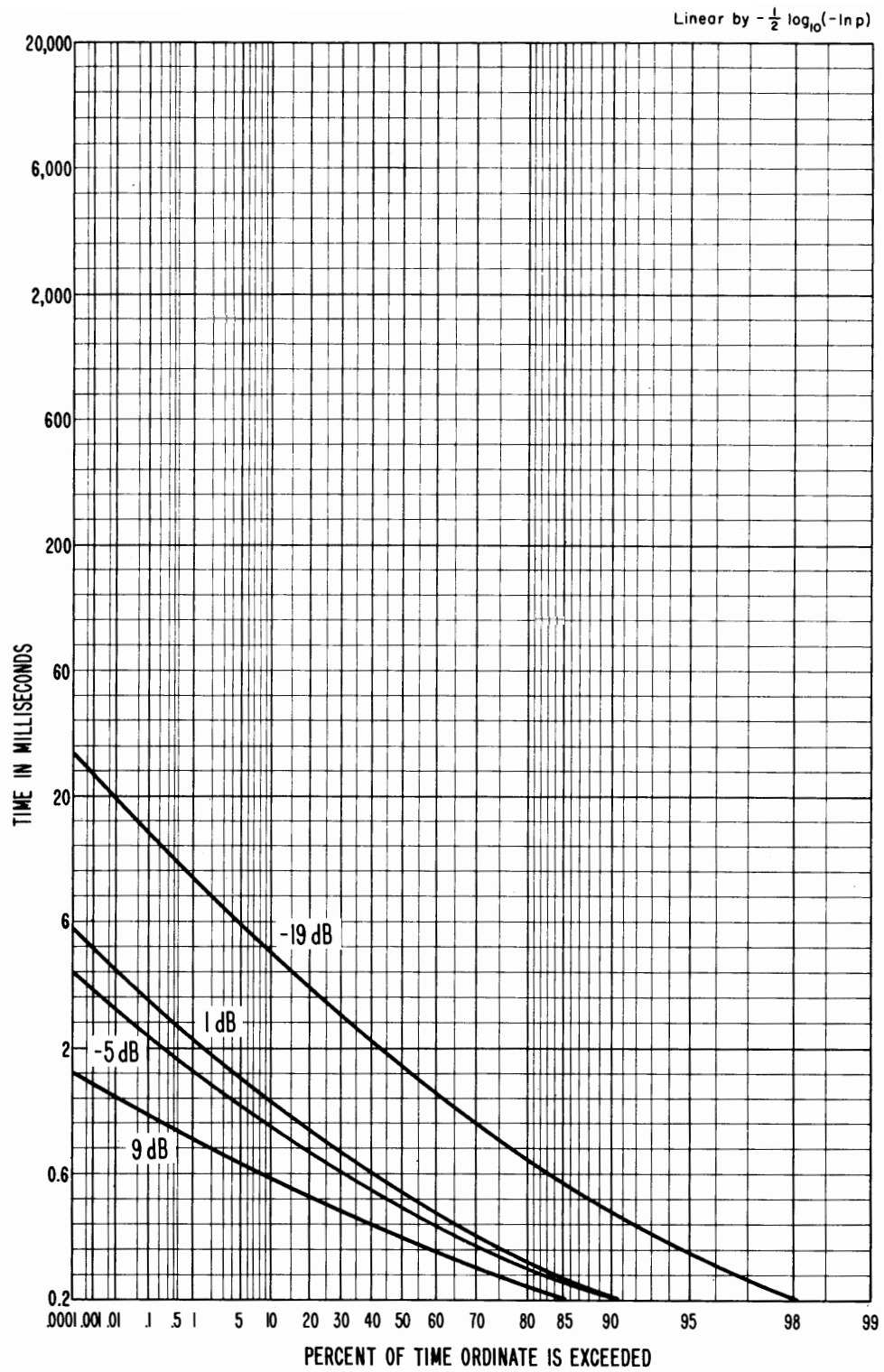

Figure 7-c. PDD, 1 MHz, vertical component, 1.2 kHz predetection bandwidth, April 24, 1973, 10:30 a.m., Grace Mine.

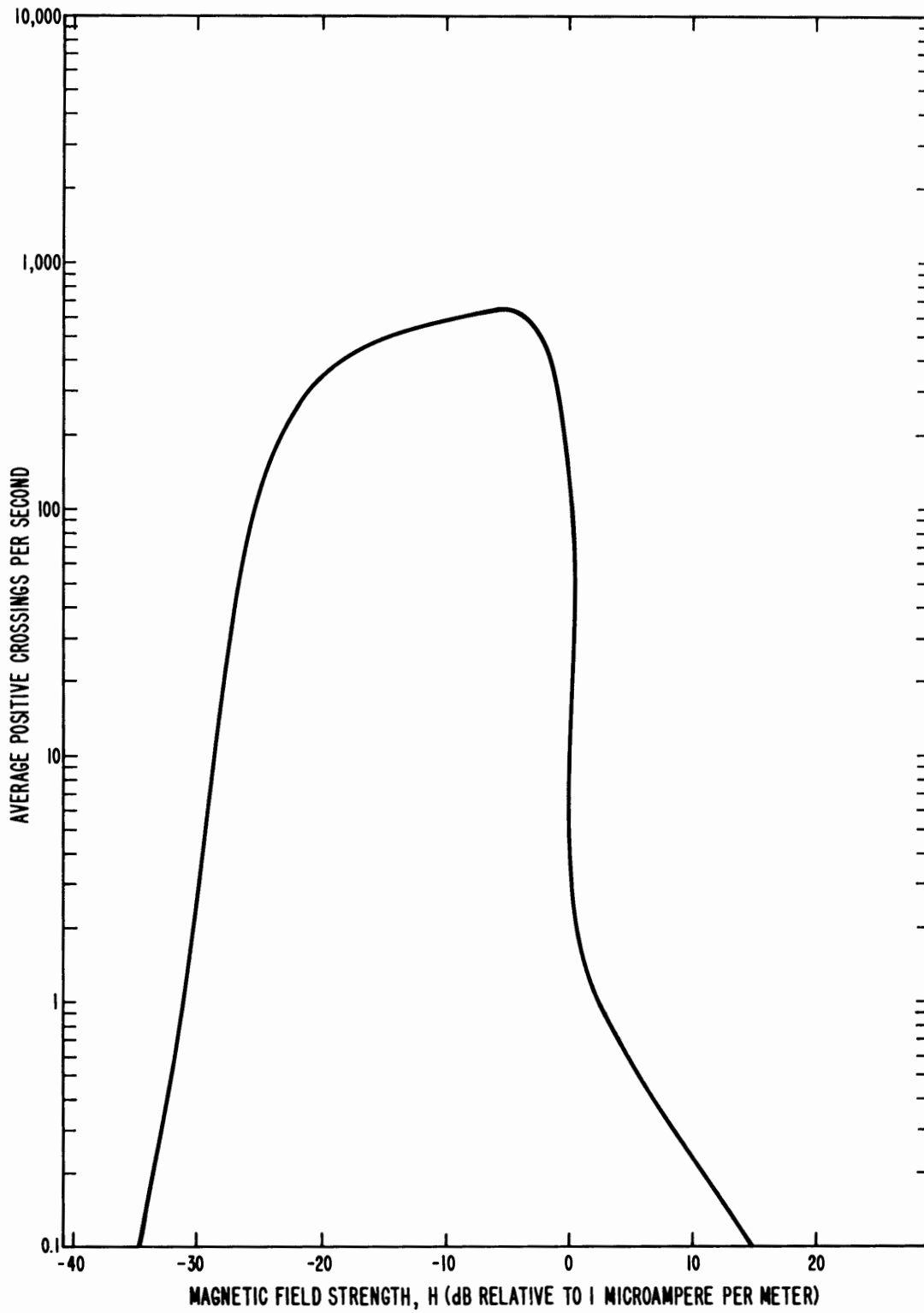

Figure 7-d. ACR, 1 MHz, vertical component, 1.2 kHz predetection bandwidth, April 24, 1973, 10:30 a.m., Grace Mine.

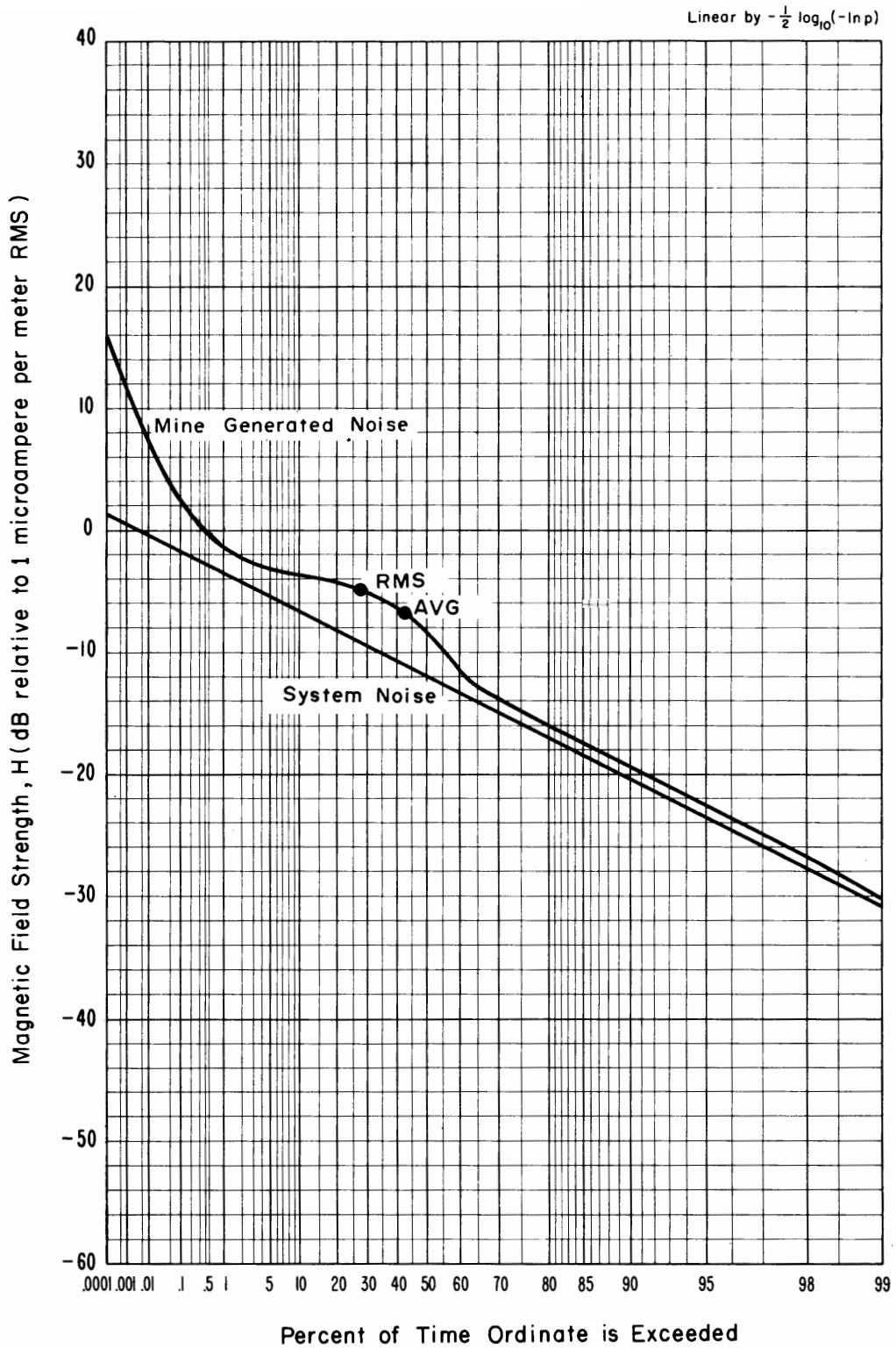

Figure 7-e. APD, 1 MHz, vertical component, 1.2 kHz predetection bandwidth, April 24, 1973, 10:30 a.m., Grace Mine.

051120

TAU MIN. = 3.000 T/TAU = 1.0000

MEAN VALUE = 2.3393+001

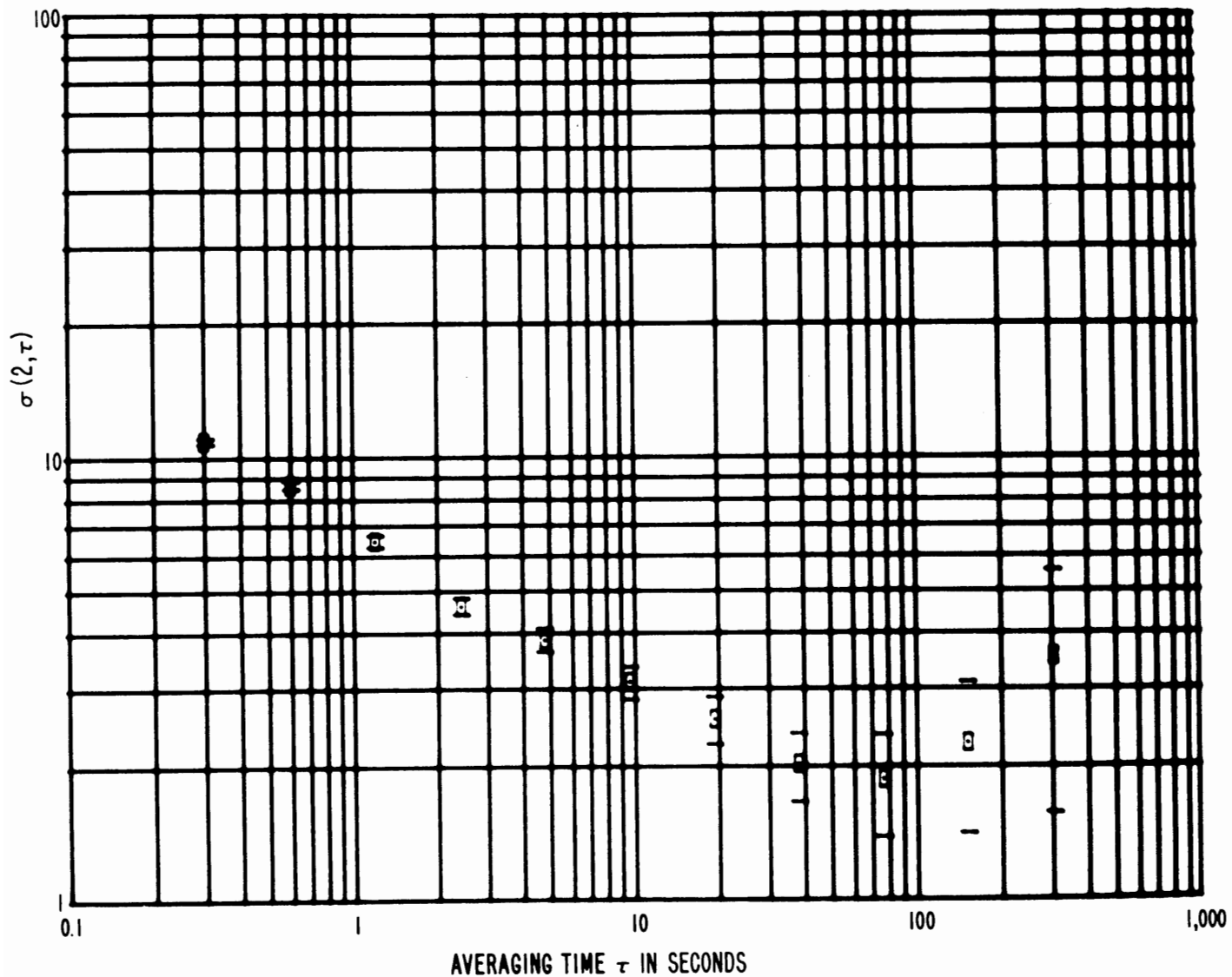

Figure 8-a. AVA, 1 MHz, vertical component, 1.2 kHz predetection bandwidth, April 10, 1973, 1:10 p.m., McElroy Mine.

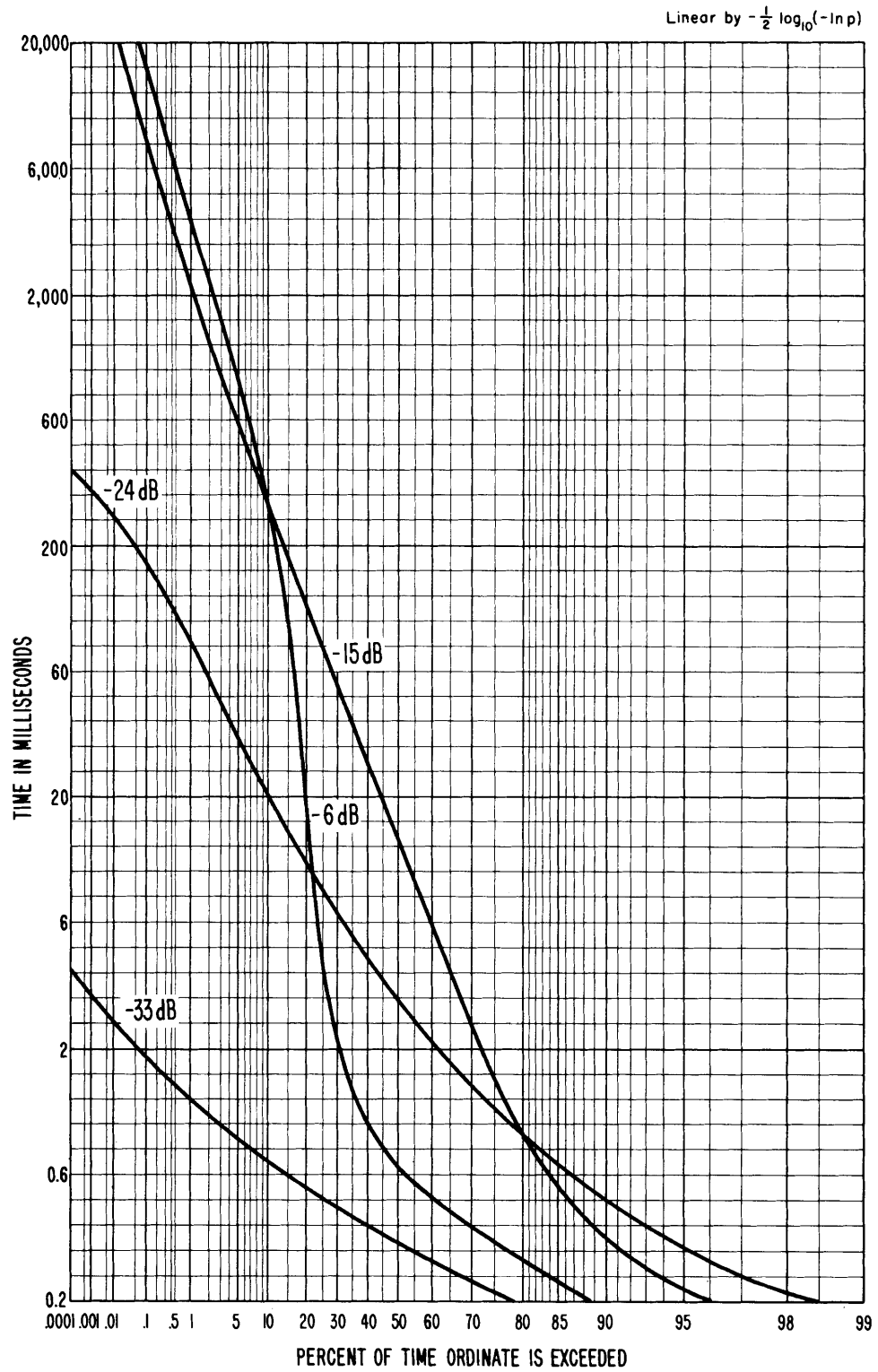

Figure 8-b. ISD, 1 MHz, vertical component, 1.2 kHz predetection bandwidth, April 10, 1973, 1:10 p.m., McElroy Mine.

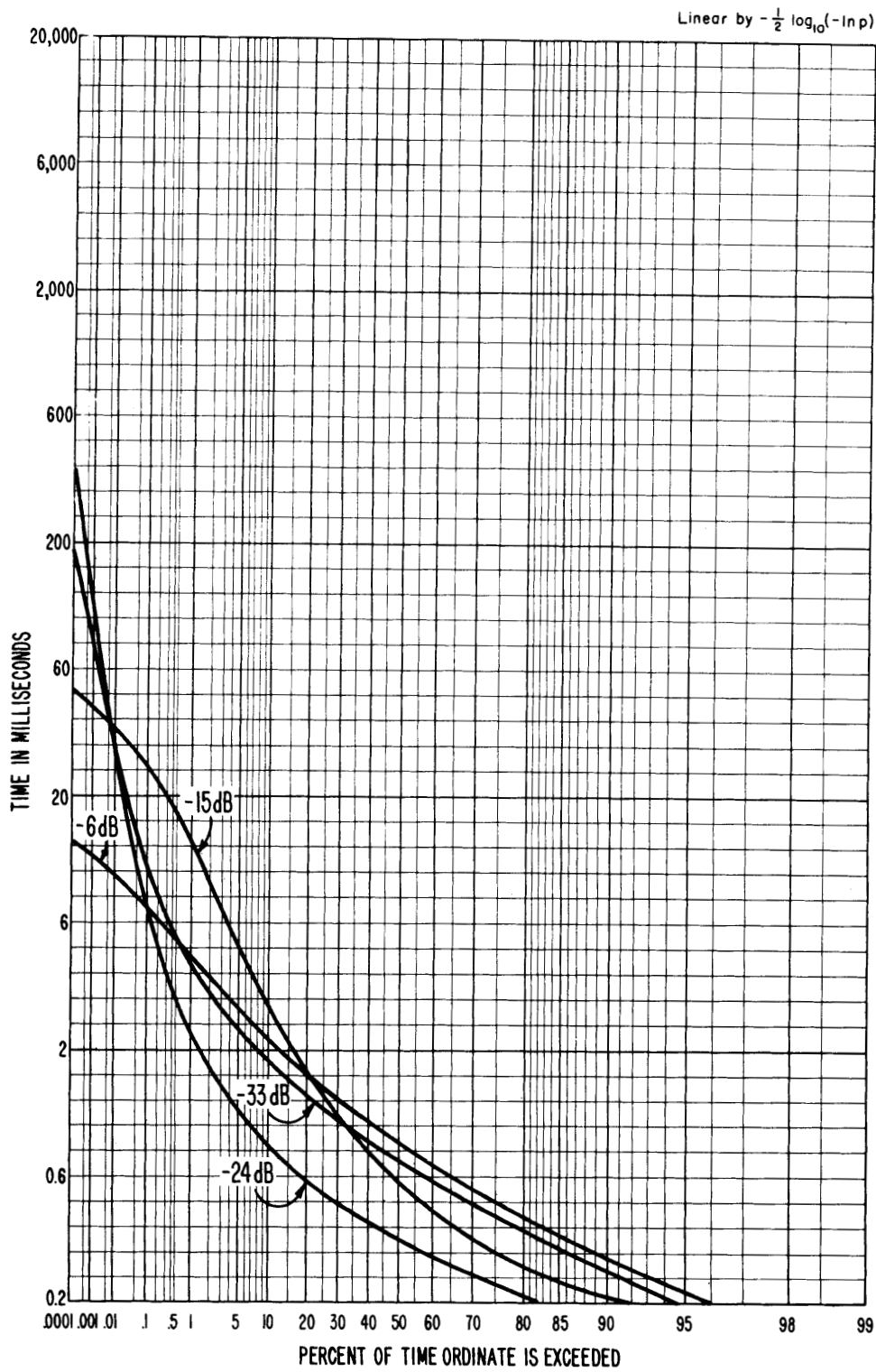

Figure 8-c. PDD, 1 MHz, vertical component, 1.2 kHz predetection bandwidth, April 10, 1973, 1:10 p.m., McElroy Mine.

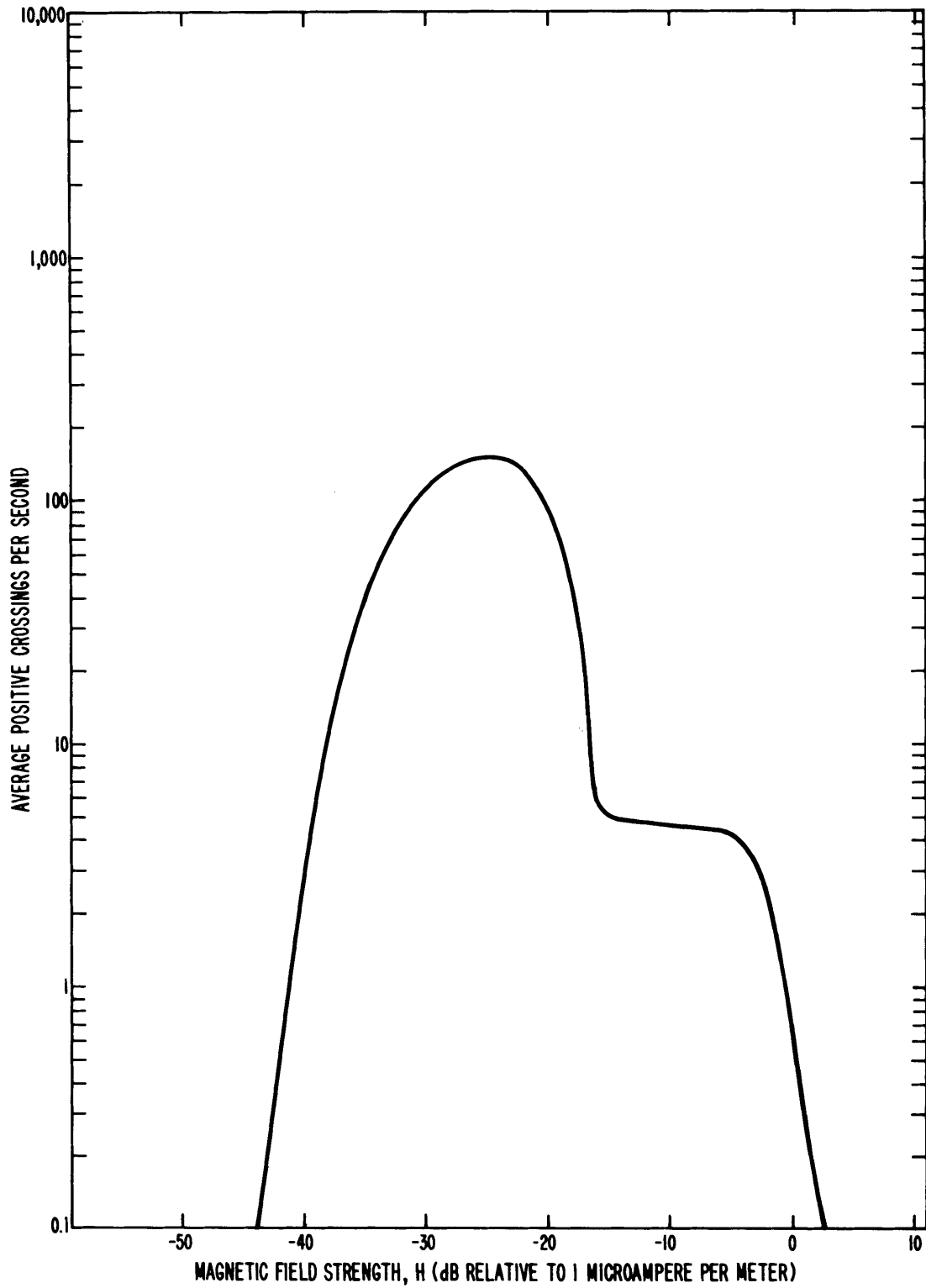

Figure 8-d. ACR, 1 MHz, vertical component, 1.0 kHz predetection bandwidth, April 10, 1973, 1:10 p.m., McElroy Mine.

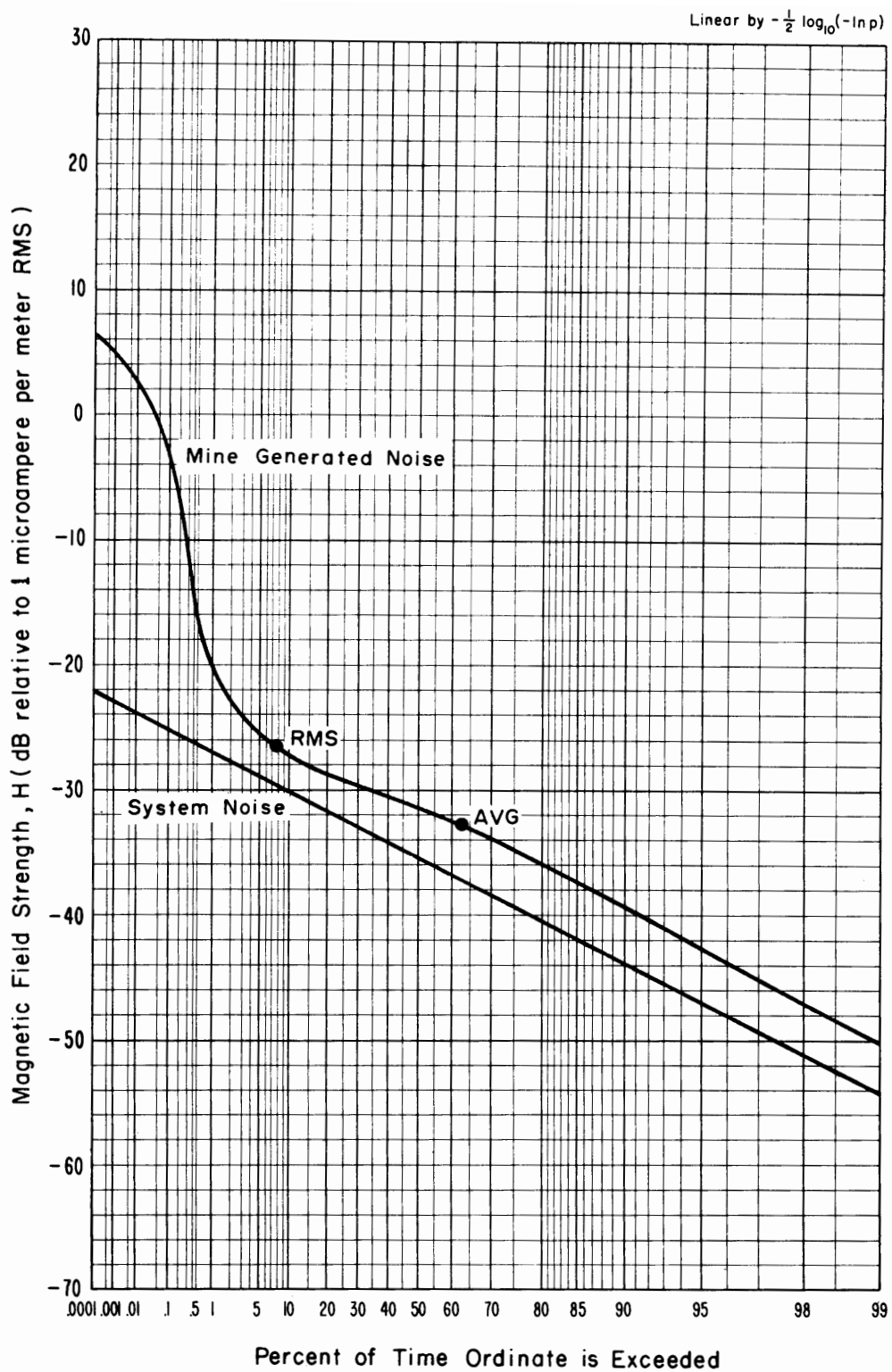

Figure 8-e. APD, 1 MHz, vertical component, 1.0 kHz predetection bandwidth, April 10, 1973, 1:10 p.m., McElroy Mine.

054120

TAU MIN. = 3.000 T/TAU= 1.0000

MEAN VALUE = 1.7540+001

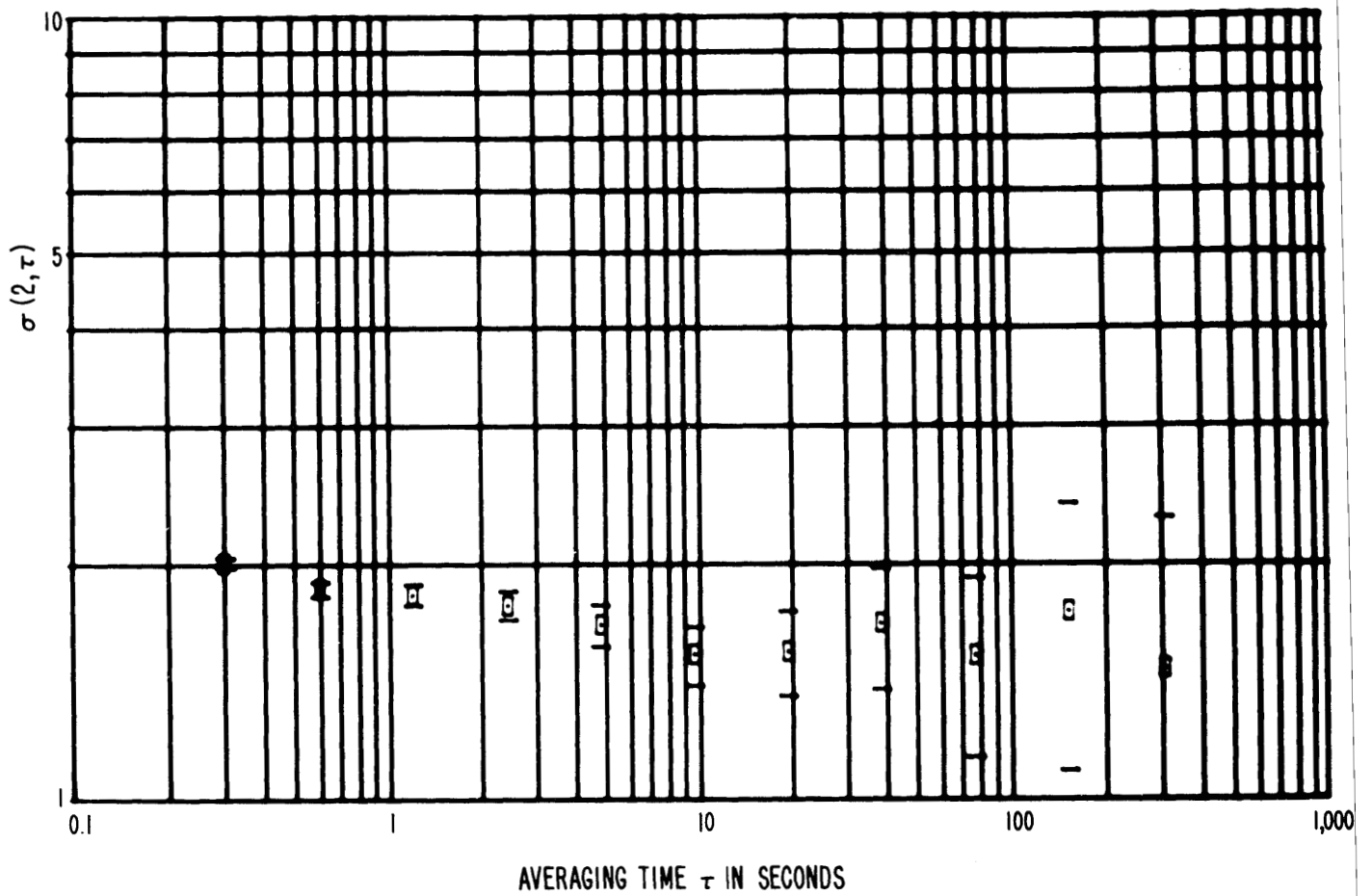

Figure 9-a. AVA, 10 kHz, vertical component, 1.0 kHz predetection bandwidth, April 17, 1973, 11:40 a.m., Itmann No. 3.

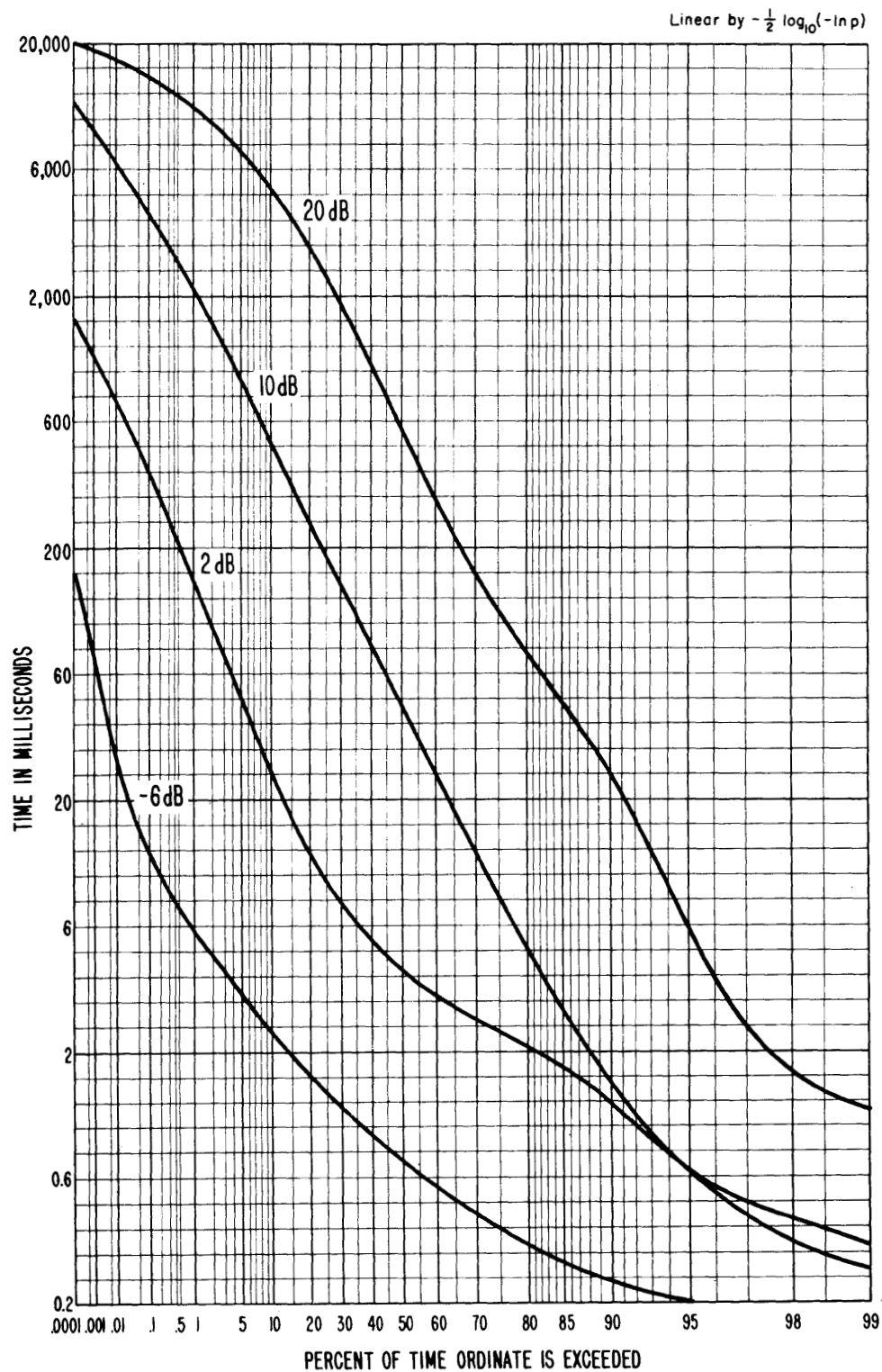

Figure 9-b. ISD, 10 kHz, vertical component, 1.0 kHz predetection bandwidth, April 17, 1973, 11:40 a.m., Itmann No. 3.

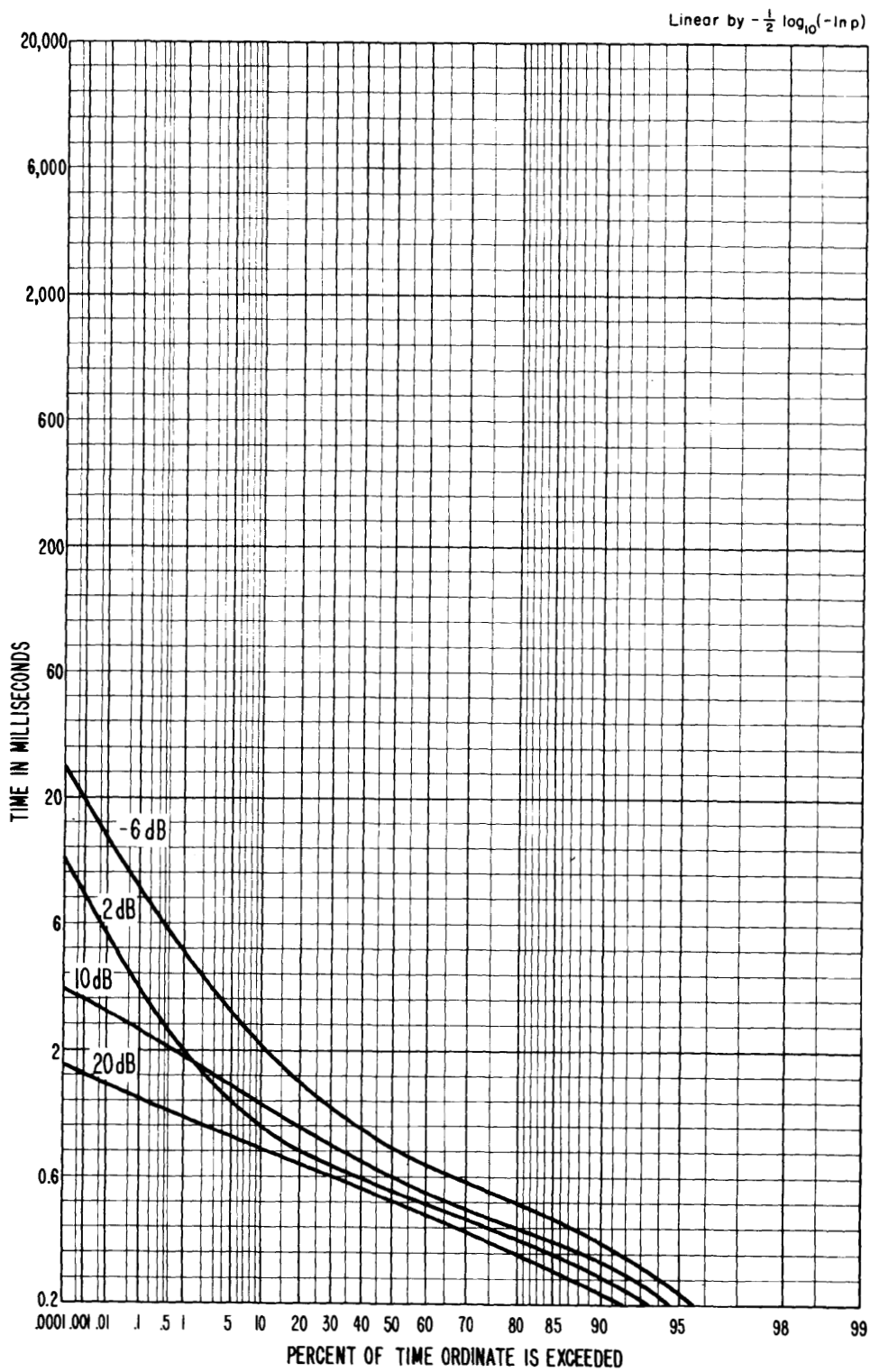

Figure 9-c. PDD, 10 kHz, vertical component, 1.0 kHz predetection bandwidth, April 17, 1973, 11:40 a.m., Itmann No. 3.

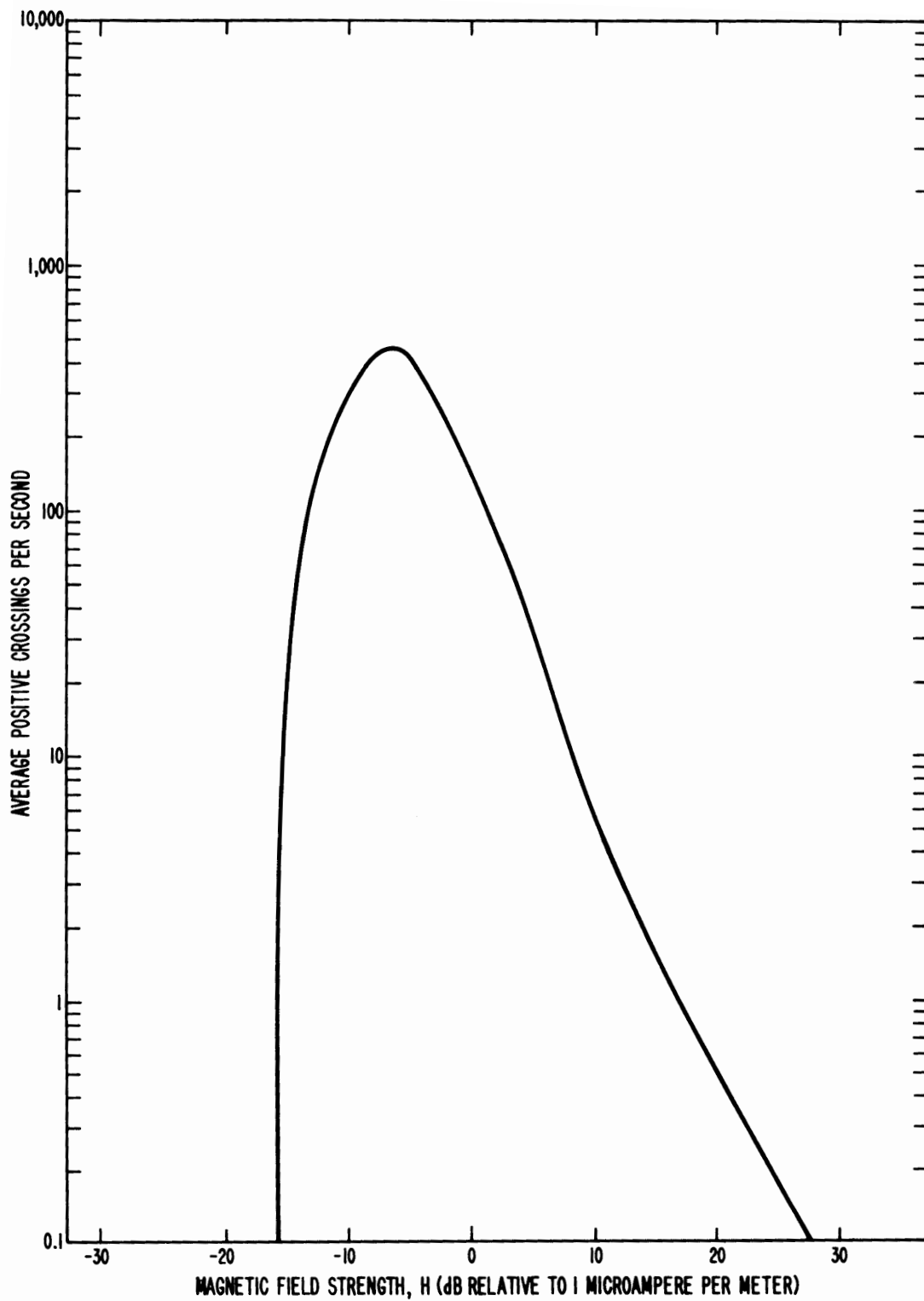

Figure 9-d. ACR, 10 kHz, vertical component, 1.0 kHz predetection bandwidth, April 17, 1973, 11:40 a.m., Itmann No. 3.

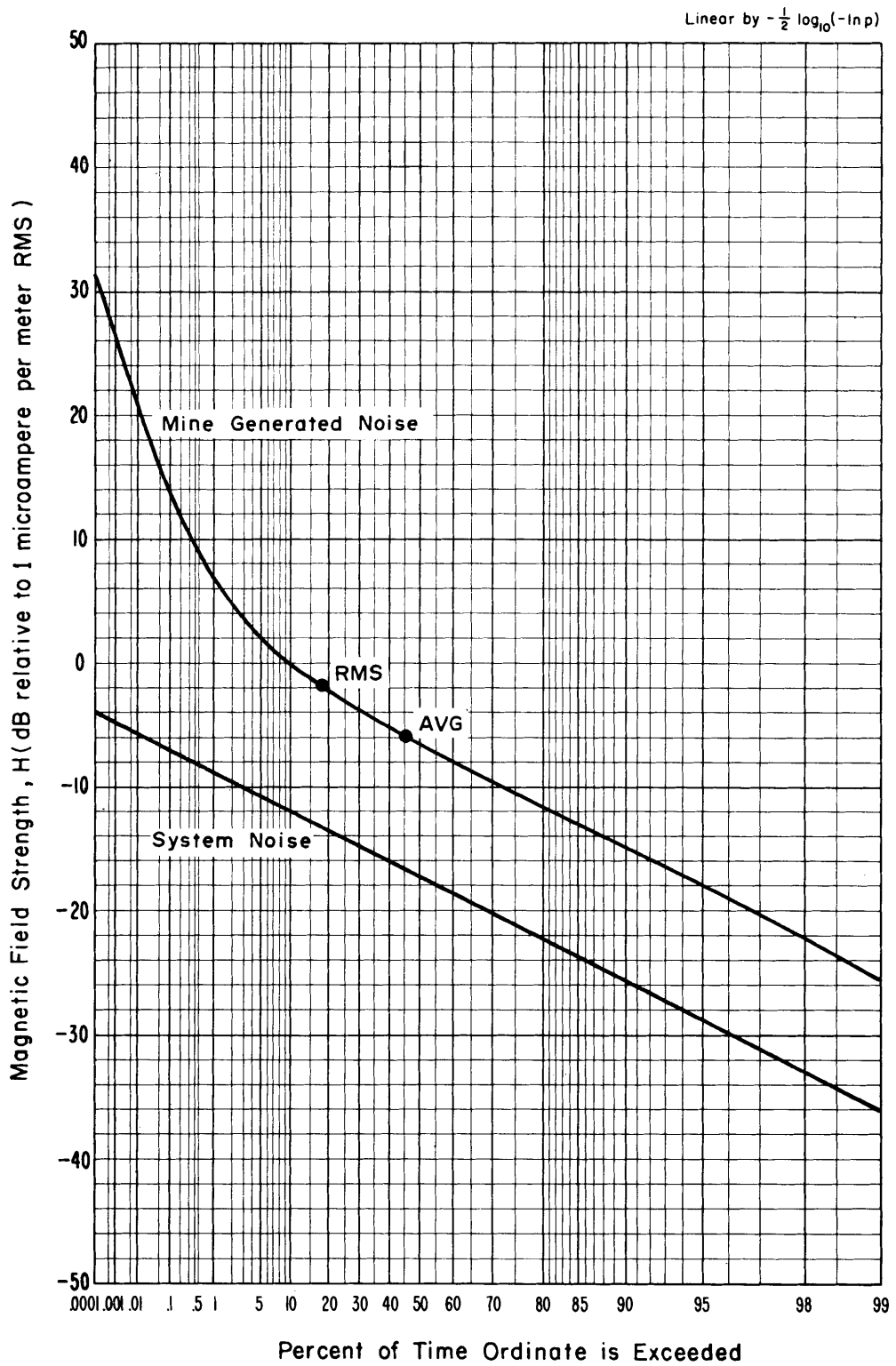

Figure 9-e. APD, 10 kHz, vertical component, 1.0 kHz predetection bandwidth, April 17, 1973, 11:40 a.m., Itmann No. 3.

058120

TAU MIN. = 3.000 T/TAU = 1.0000

MEAN VALUE = 2.4862+001

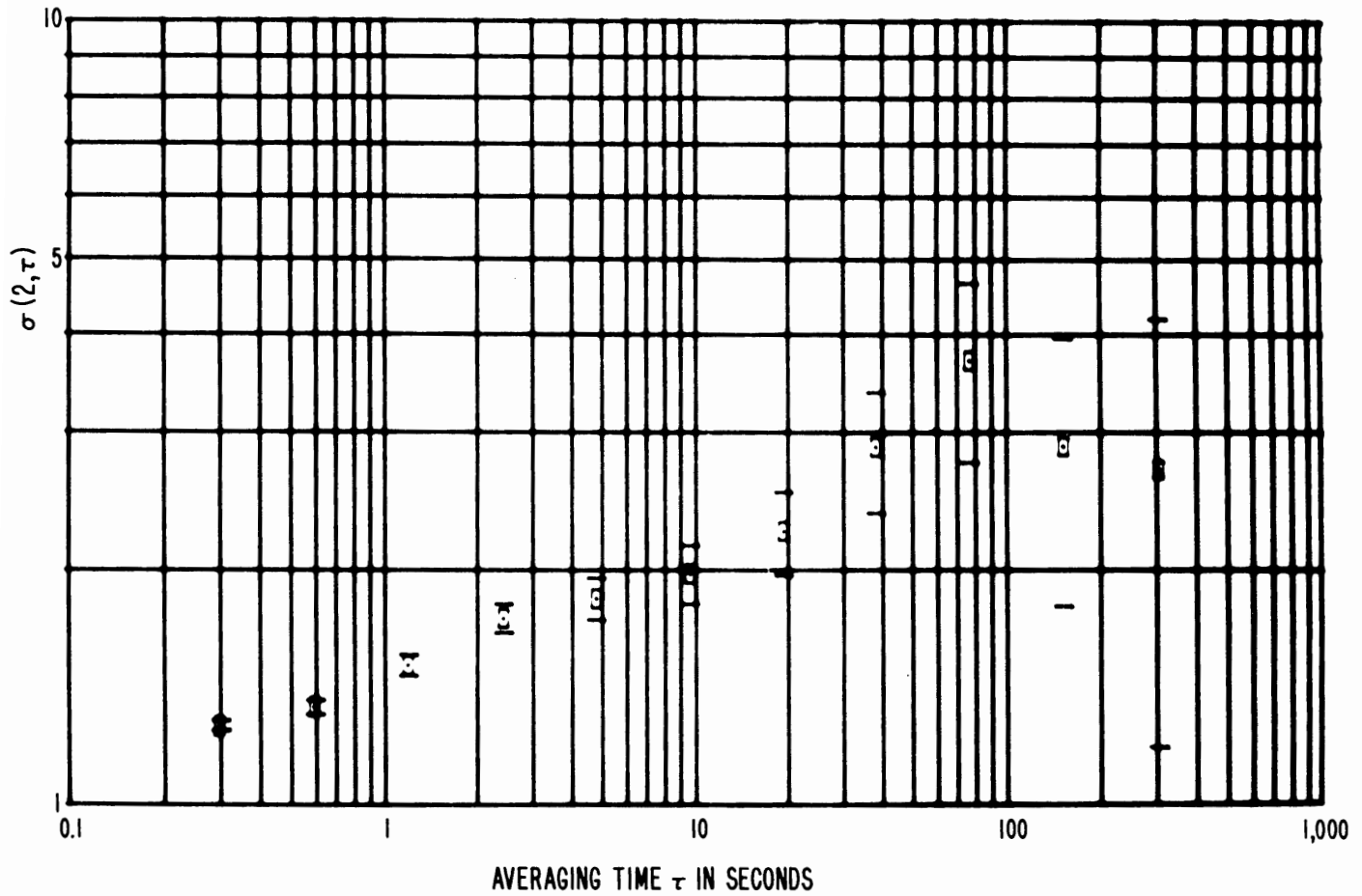

Figure 10-a. AVA, 70 kHz, vertical component, 1.0 kHz predetection bandwidth, April 17, 1973, 12:50 p.m., Itmann No. 3.

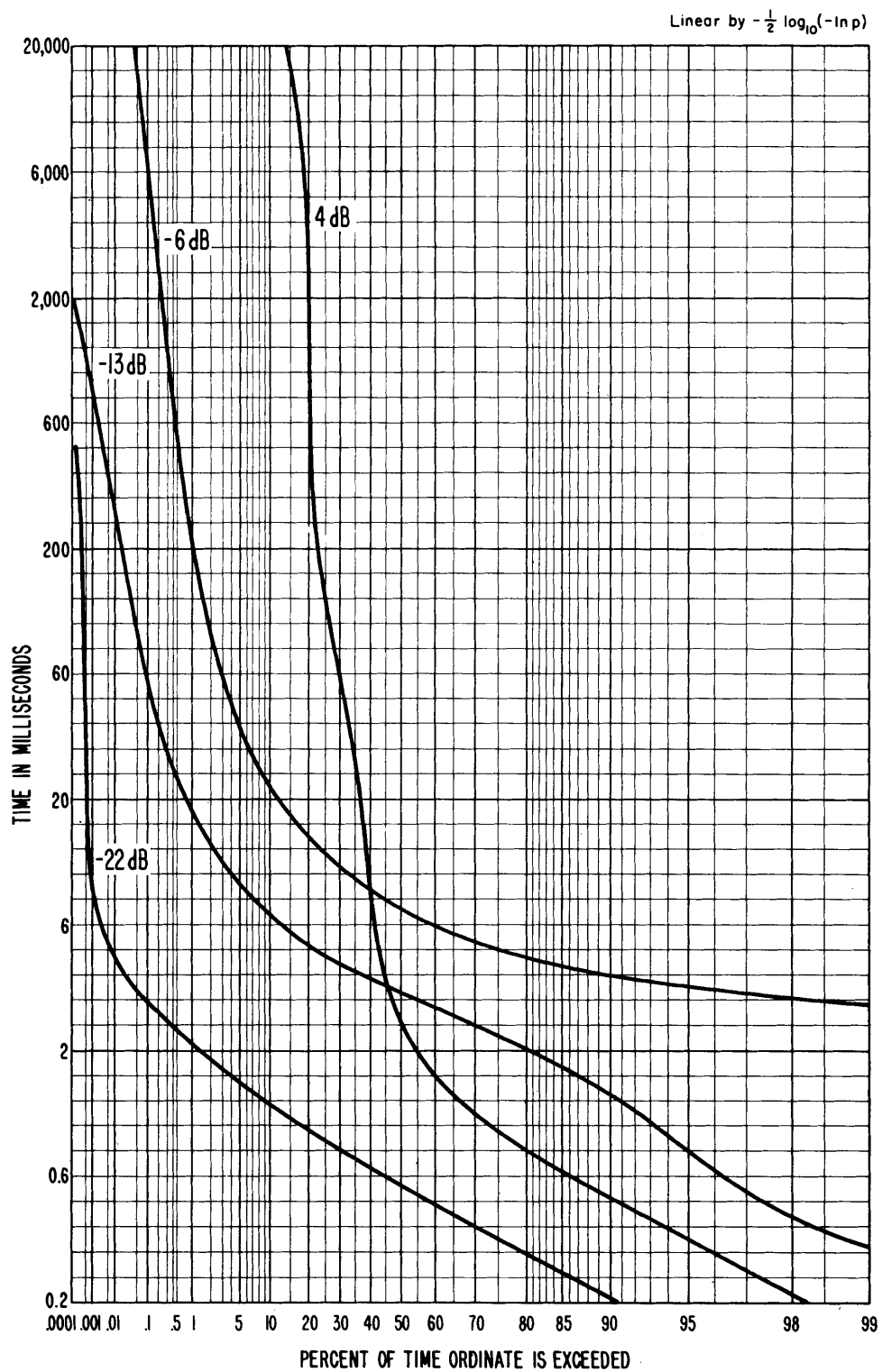

Figure 10-b. ISD, 70 kHz, vertical component, 1.0 kHz predetection bandwidth, April 17, 1973, 12:50 p.m., Itmann No. 3.

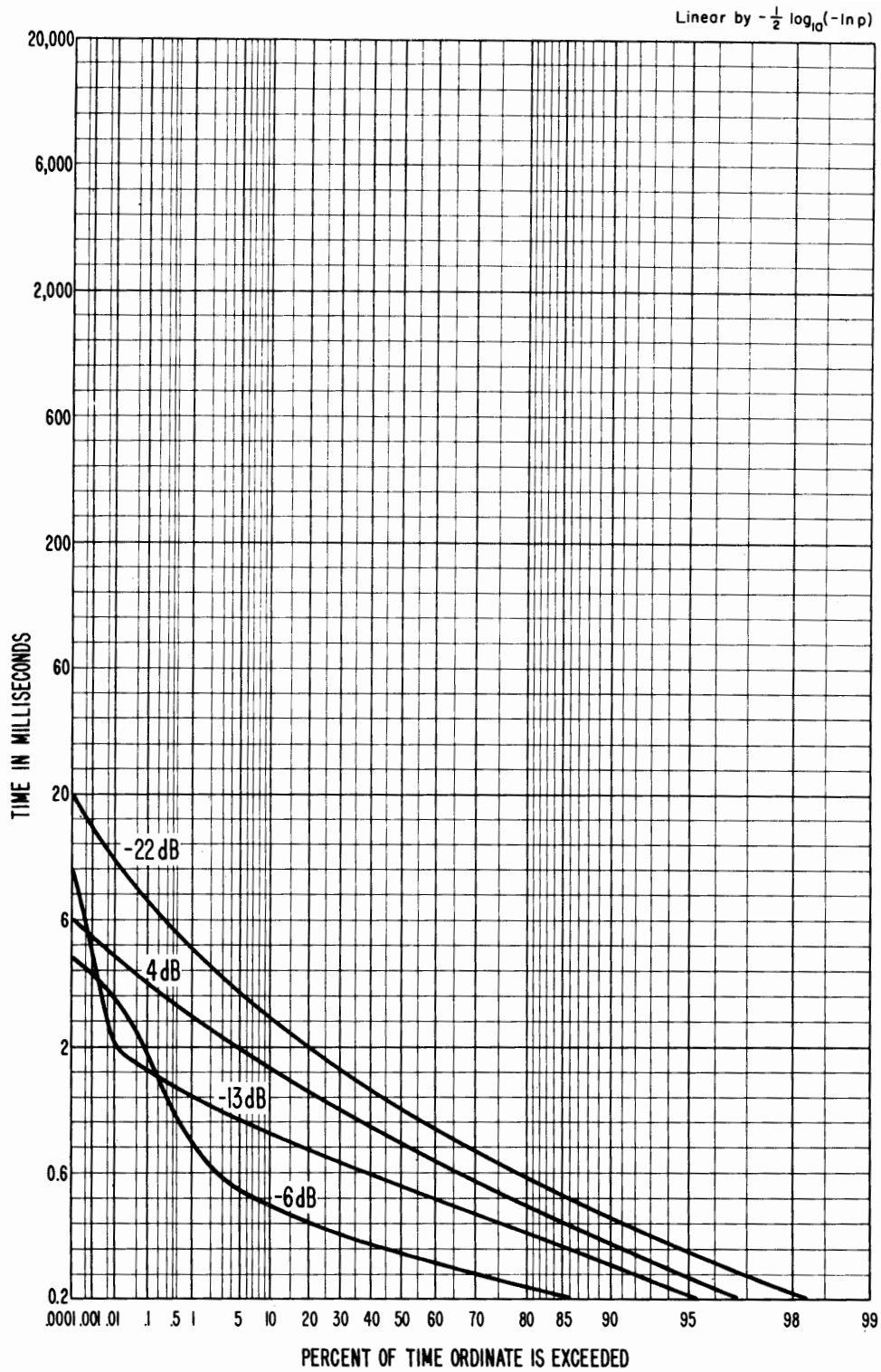

Figure 10-c. PDD, 70 kHz, vertical component, 1.0 kHz predetection bandwidth, April 17, 1973, 12:50 p.m., Itmann No. 3.

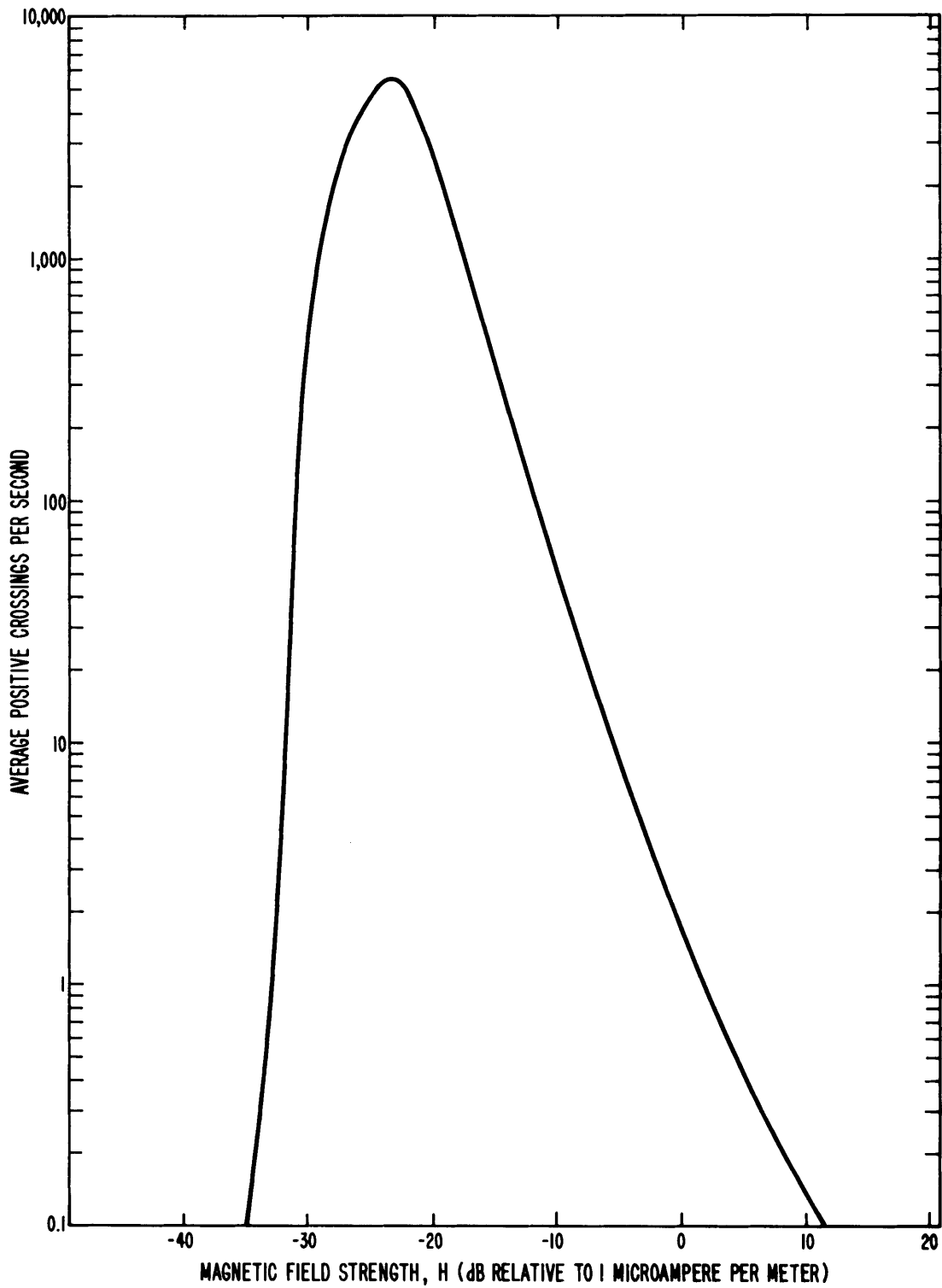

Figure 10-d. ACR, 70 kHz, vertical component, 1.0 kHz predetection bandwidth, April 17, 1973, 12:50 p.m., Itmann No. 3.

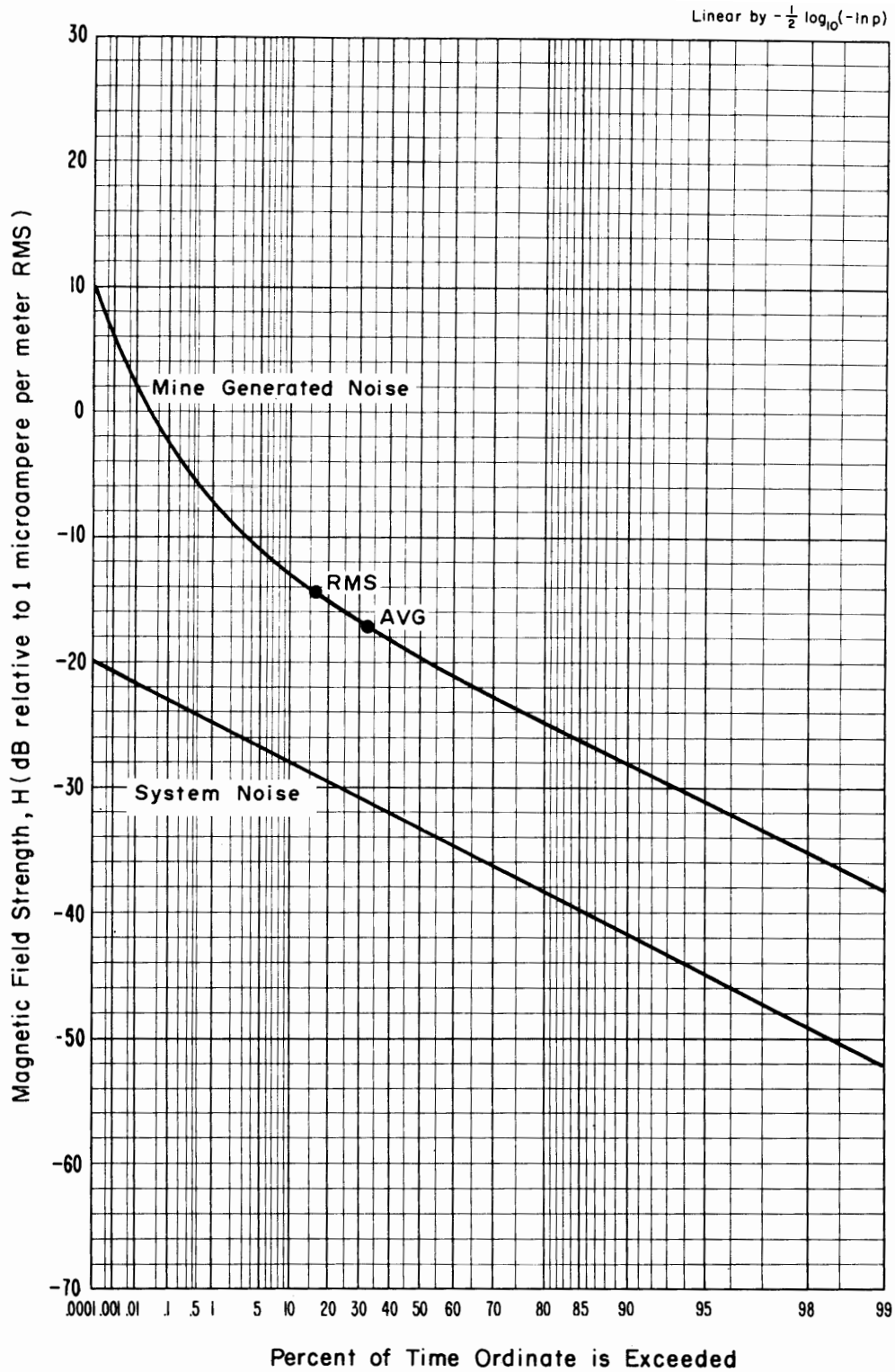

Figure 10-e. APD, 70 kHz, vertical component, 1.0 kHz predetection bandwidth, April 17, 1973, 12:50 p.m., Itmann No. 3.

056120

TAU MIN. = 3.000 T/TAU = 1.0000

MEAN VALUE = 2.7118+001

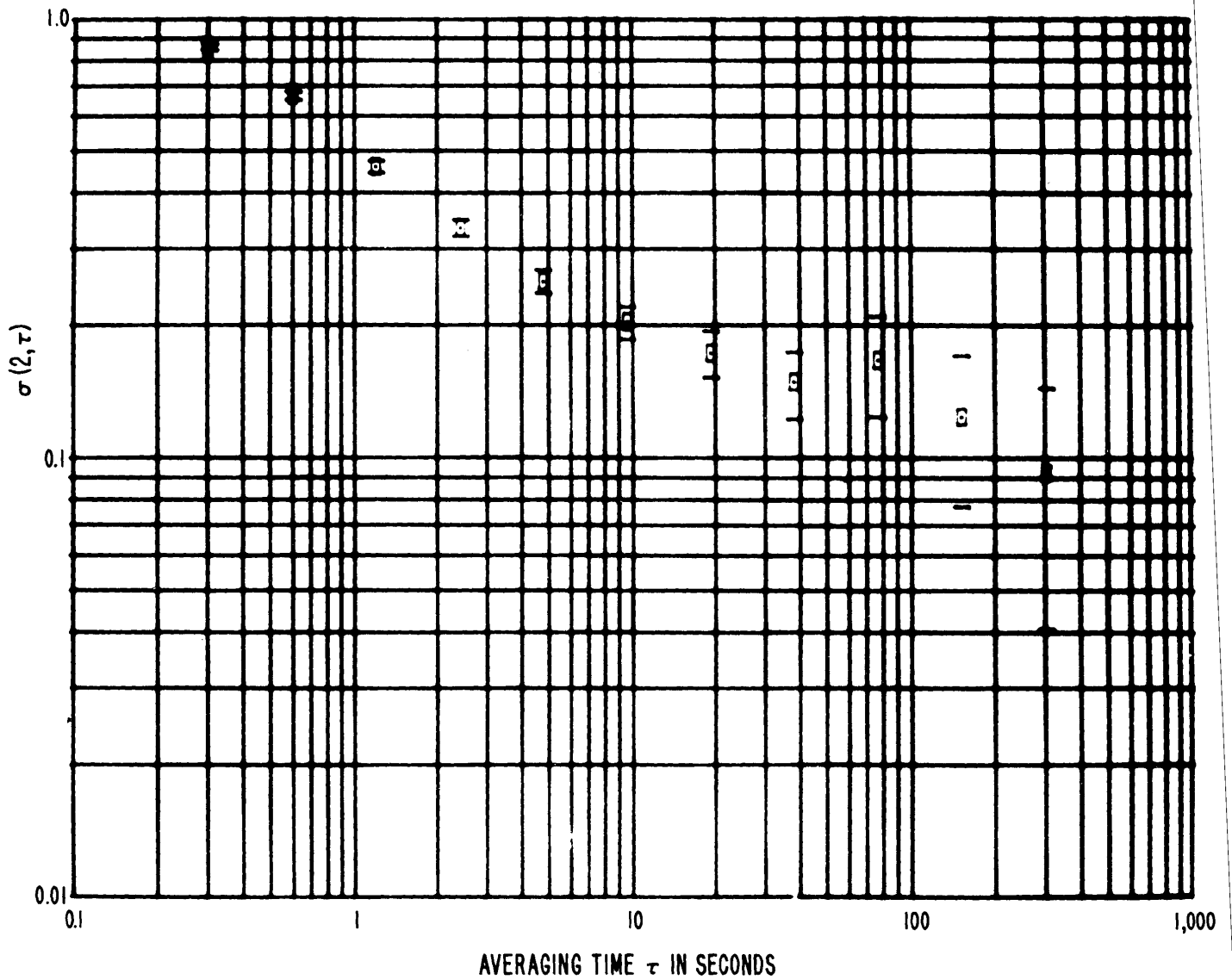

Figure 11-a. AVA, 1 MHz, vertical component, 1.2 kHz predetection bandwidth, April 17, 1973, 12:20 p.m., Itmann No. 3.

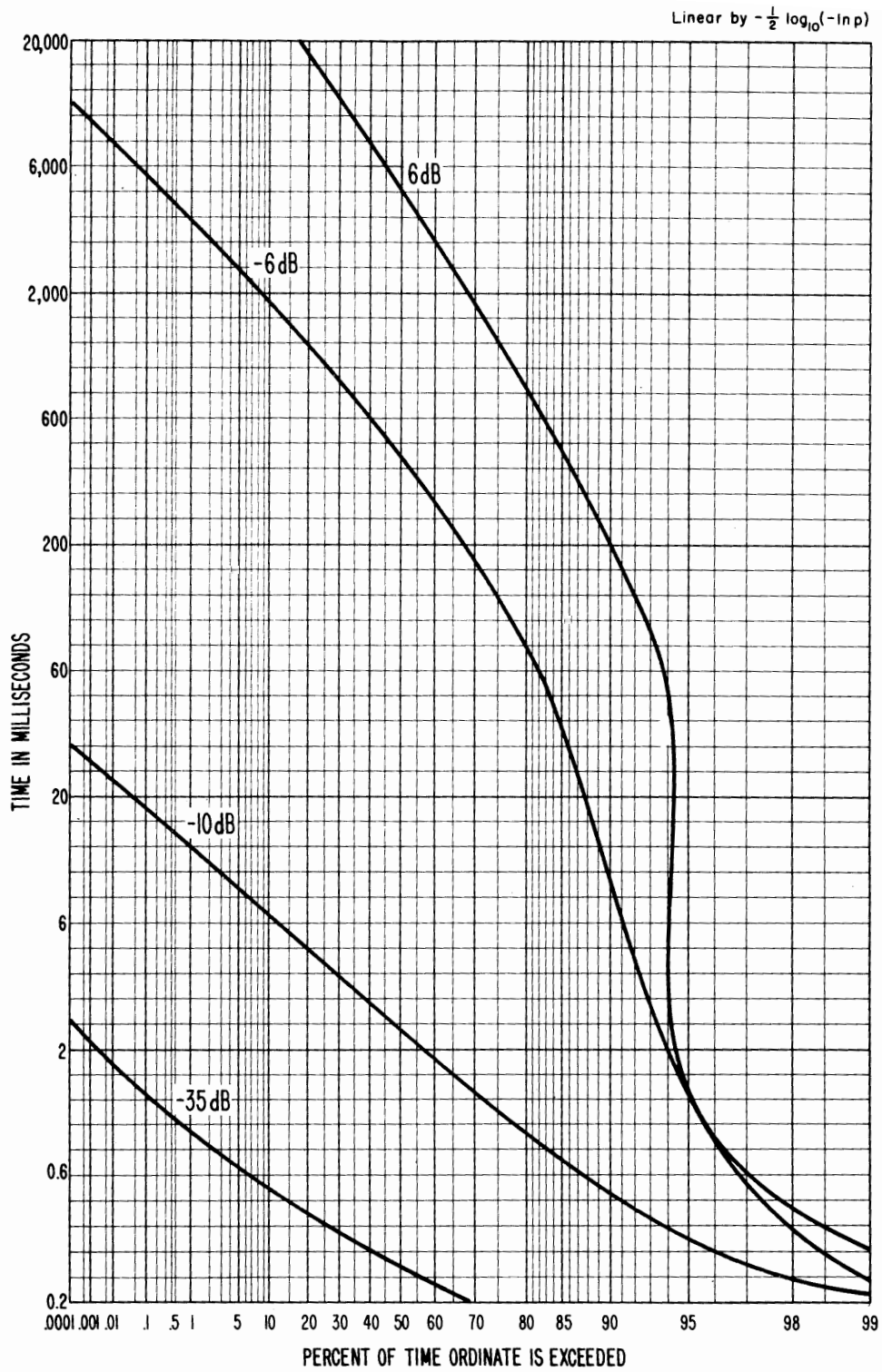

Figure 11-b. ISD, 1 MHz, vertical component, 1.2 kHz predetection bandwidth, April 17, 1973, 12:20 p.m., Itmann No. 3.

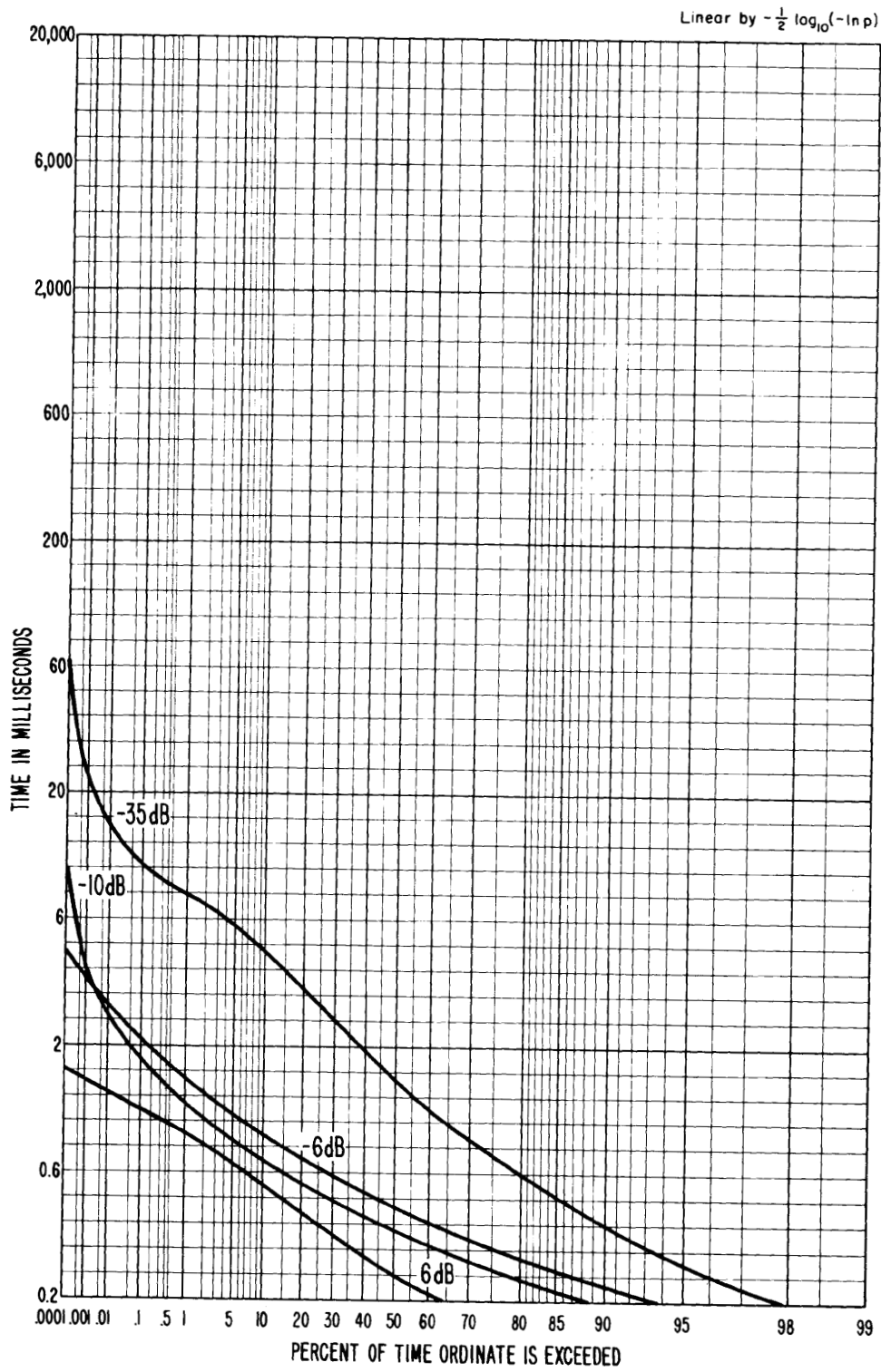

Figure 11-c. PDD, 1 MHz, vertical component, 1.2 kHz predetection bandwidth, April 17, 1973, 12:20 p.m., Itmann No. 3.

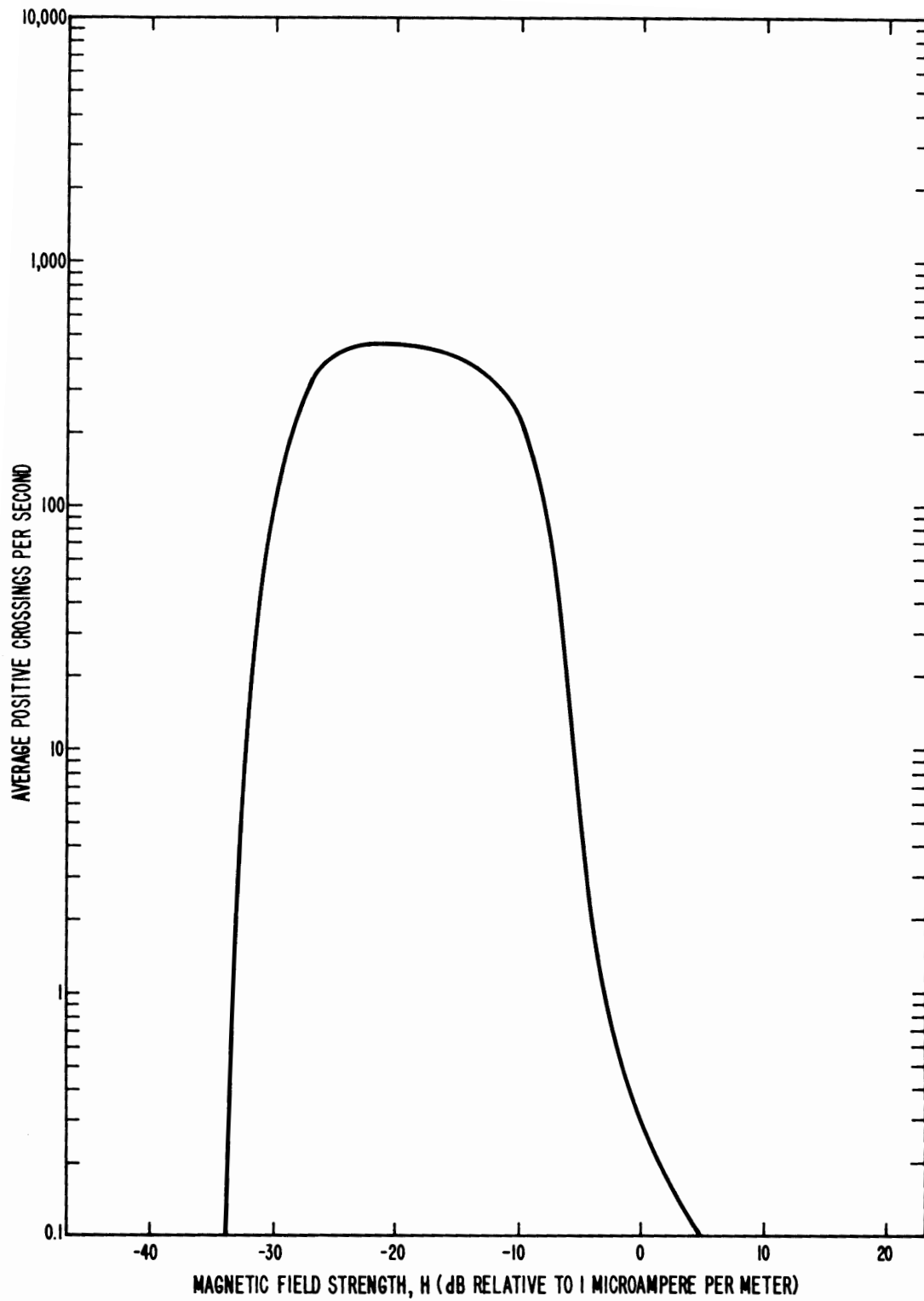

Figure 11-d. ACR, 1 MHz, vertical component, 1.2 kHz predetection bandwidth, April 17, 1973, 12:20 p.m., Itmanr No. 3.

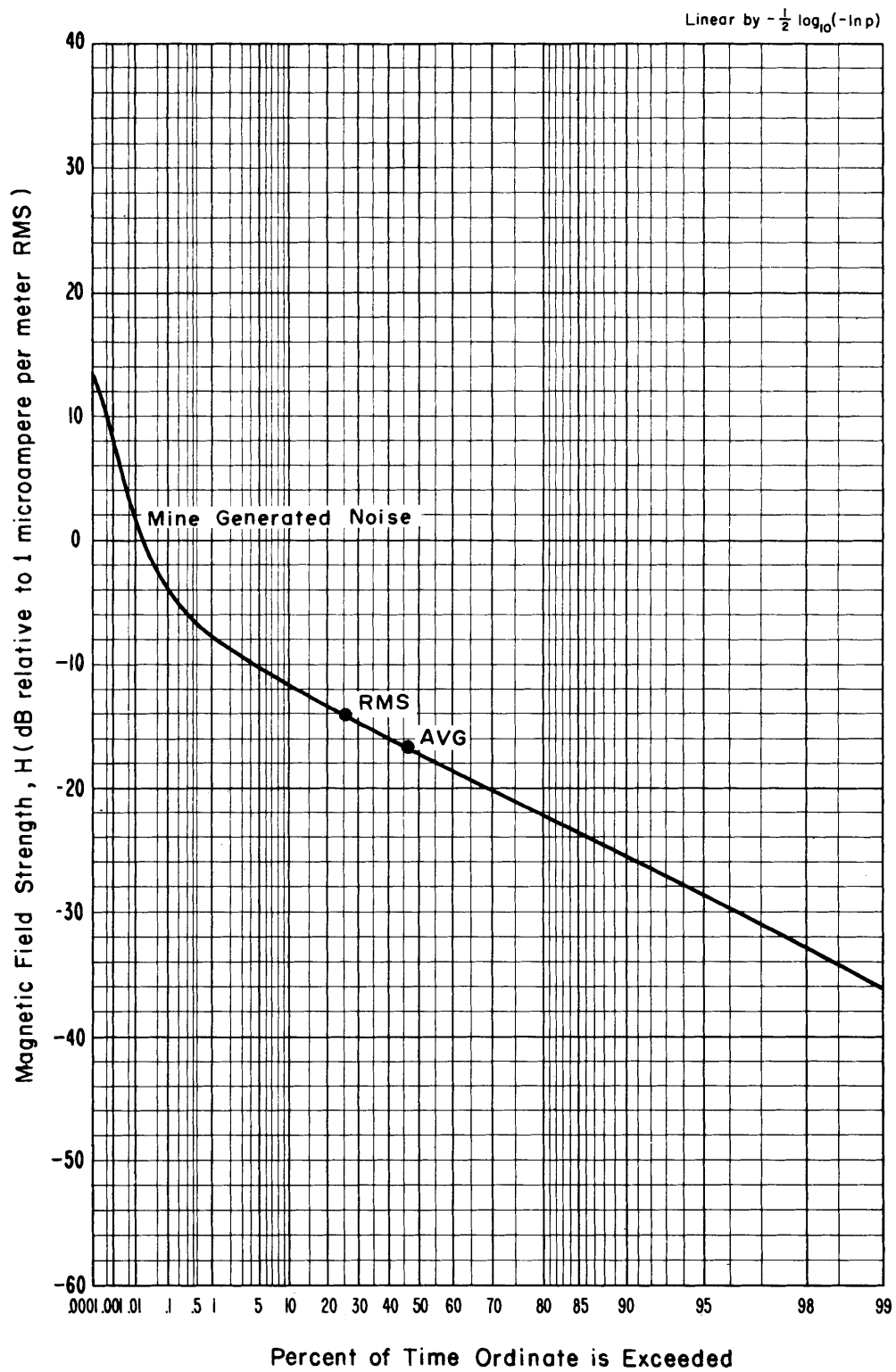

Figure 11-e. APD, 1 MHz, vertical component, 1.2 kHz predetection bandwidth, April 17, 1973, 12:20 p.m., Itmann No. 3.

U.S. DEPT. OF COMM. BIBLIOGRAPHIC DATA SHEET	1. PUBLICATION OR REPORT NO. NBSIR 74-378	2. Gov't Accession No.	3. Recipient's Accession No.
4. TITLE AND SUBTITLE Time and Amplitude Statistics for Electromagnetic Noise in Mines		5. Publication Date	6. Performing Organization Code
7. AUTHOR(S) Motohisa Kanda		8. Performing Organization	
9. PERFORMING ORGANIZATION NAME AND ADDRESS NATIONAL BUREAU OF STANDARDS DEPARTMENT OF COMMERCE Washington, D. C. 20234		10. Project/Task/Work Unit No. 2728412	11. Contract/Grant No.
12. Sponsoring Organization Name and Address Same as Item 9.		13. Type of Report & Period Covered	14. Sponsoring Agency Code
15. SUPPLEMENTARY NOTES			
16. ABSTRACT (A 200-word or less factual summary of most significant information. If document includes a significant bibliography or literature survey, mention it here.) The time and amplitude statistics necessary to adequately describe electromagnetic (EM) noise in mines are illustrated through computer software techniques. They are 1) Allan Variance Analyses (AVA), 2) Interpulse Spacing Distributions (ISD), 3) Pulse Duration Distributions (PDD), 4) Average Crossing Rates (ACR), and 5) Amplitude Probability Distributions (APD). These statistics are illustrated using data taken from a rather large store of raw analog data recorded in operational mines. The curves generated for the illustrations characterize the noise environment in the mines from which the corresponding data were taken, and should aid in the design of reliable communication systems for such mines.			
17. KEY WORDS (Alphabetical order, separated by semicolons) Allan variance analysis; amplitude probability distribution; amplitude statistics; average crossing rate; electromagnetic interference; electromagnetic noise; impulsive noise; interpulse spacing distribution; magnetic field strength; man-made noise; pulse duration distribution; time statistics			
18. AVAILABILITY STATEMENT <input checked="" type="checkbox"/> UNLIMITED. <input type="checkbox"/> FOR OFFICIAL DISTRIBUTION. DO NOT RELEASE TO NTIS.		19. SECURITY CLASS UNCLASSIFIED	21. NO. OF PAGES
		20. SECURITY CLASS (THIS PAGE) UNCLASSIFIED	22. Price