

NBSIR 74-390

ELECTROMAGNETIC NOISE IN ITMANN MINE

W. D. Bensema
M. Kanda
J. W. Adams

Electromagnetics Division
Institute for Basic Standards
National Bureau of Standards
Boulder, Colorado 80302

The views and conclusions contained in this document should not be interpreted as necessarily representing the official policies or recommendations of the Interior Department's Bureau of Mines of the U. S. Government

June 1974

Prepared for
U. S. Bureau of Mines
United States Department of the Interior
Pittsburgh, Pennsylvania 15222
Working Fund Agreement HO 133005



U.S. DEPARTMENT OF COMMERCE, Frederick B. Dent, Secretary

NATIONAL BUREAU OF STANDARDS Richard W. Roberts, Director

FOREWORD

This report was prepared by the National Bureau of Standards, Boulder, Colorado, under USBM Contract No. HO 133005. The contract was initiated under the Coal Mine Health and Safety Research Program. It was administered under the technical direction of the Pittsburgh Mining and Safety Research Center with Mr. Howard Parkinson and Mr. Harry Dobroski acting as the technical project officers.

This report is a summary of the work completed as part of this contract during the period January 1973 to June 1974. This report was submitted by the authors in October 1974.

CONTENTS

	<u>Page</u>
1. INTRODUCTION-----	1
1.1 Background-----	2
1.2 Mine Description-----	3
2. MEASUREMENT INSTRUMENTATION-----	5
3. SPECTRUM MEASUREMENT RESULTS-----	10
3.1 Introduction and Uncertainties-----	10
3.2 Antenna Sites-----	10
3.3 Electromagnetic (EM) Noise Spectrum Results---	11
3.3.1 Interpretation-----	11
3.3.2 Cabin Creek Panel-----	11
3.3.3 Farley Panel-----	13
3.4 Miscellaneous Measurements-----	14
3.4.1 Electric Field-----	14
3.4.2 Measurements of Voltage Between Roof Bolts-----	15
3.5 Intercomparison of Different Mines-----	16
3.5.1 Roof Bolt Voltage Intercomparison-----	16
3.5.2 Summary of 1 kHz to 3 kHz Data-----	17
3.5.3 Intercomparison of 3 kHz to 200 kHz Data-----	18
4. AMPLITUDE PROBABILITY DISTRIBUTION MEASUREMENTS----	47
4.1 Introduction and Uncertainties-----	47
4.2 Results-----	48
4.2.1 Introduction-----	48
4.2.2 Measurement Results-----	49
4.2.3 RMS and Average Values-----	51
5. CONCLUSIONS-----	98
6. RECOMMENDATIONS-----	99
7. ACKNOWLEDGMENTS-----	100
8. REFERENCES-----	101
9. APPENDIX-----	102

LIST OF FIGURES

		<u>Page</u>
Figure 2-1.	Block diagram of portable instrumentation-	7
Figure 2-2.	System for field recording data to obtain amplitude probability distributions-----	8
Figure 2-3.	Block diagram of laboratory recording system modified for field use-----	9
Figure 3-1.	Map of Itmann Mine where measurements were made, Cabin Creek panel-----	19
Figure 3-2.	Spectrum with mine in operation, measurements made 10 meters from end of longwall face, Cabin Creek panel. Spectral resolution of 78.1 Hz-----	20
Figure 3-3.	Spectrum with mine in operation, measurements made 10 meters from end of longwall face, Cabin Creek panel. Spectral resolution of 3.91 Hz-----	21
Figure 3-4.	Spectrum with mine in operation, measurements made 5 meters from end of longwall face, Cabin Creek panel. Spectral resolution of 78.1 Hz-----	22
Figure 3-5.	Spectrum with mine in operation, measurements made 5 meters from end of longwall face, Cabin Creek panel. Spectral resolution of 3.91 Hz-----	23
Figure 3-6.	Spectrum with second shift in full operation, measurements made 5 meters from end of longwall face, Cabin Creek panel. Spectral resolution of 3.91 Hz-----	24
Figure 3-7.	Spectrum of quiet time between shifts, measurements made 5 meters from end of longwall face, Cabin Creek panel. Spectral resolution of 78.1 Hz-----	25
Figure 3-8.	Spectrum of quiet time between shifts, measurements made 5 meters from end of longwall face, Cabin Creek panel. Spectral resolution of 3.91 Hz-----	26

LIST OF FIGURES (continued)

	<u>Page</u>
Figure 3-9. Spectrum with mine in operation, measurements made 10 meters from end of longwall face, Farley panel. Spectral resolution of 78.1 Hz-----	27
Figure 3-10. Spectrum with mine in operation, measurements made 10 meters from end of longwall face, Farley panel. Spectral resolution of 3.91 Hz-----	28
Figure 3-11. Spectrum with hydraulic pump operating, measurements made 10 meters from end of longwall face, Farley panel. Spectral resolution of 78.1 Hz-----	29
Figure 3-12. Spectrum with hydraulic pump operating, measurements made 10 meters from end of longwall face, Farley panel. Spectral resolution of 3.91 Hz-----	30
Figure 3-13. Spectrum with conveyor belt starting up, measurements made 10 meters from end of longwall face, Farley panel. Spectral resolution of 78.1 Hz-----	31
Figure 3-14. Spectrum with conveyor belt starting up, measurements made 10 meters from end of longwall face, Farley panel. Spectral resolution of 3.91 Hz-----	32
Figure 3-15. Vertical component of magnetic field spectrum about 3 meters from longwall machine-----	33
Figure 3-16. Vertical component of magnetic field spectrum at end of haulageway in Farley panel-----	34
Figure 3-17. Vertical component of magnetic field spectrum at end of haulageway in Farley panel-----	35
Figure 3-18. Horizontal component of magnetic field spectrum at end of haulageway in Farley panel-----	36

LIST OF FIGURES (continued)

	<u>Page</u>
Figure 3-19. Vertical component of magnetic field spectrum at end of haulageway in Farley panel-----	37
Figure 3-20. Vertical component of magnetic field spectrum at end of haulageway in Farley panel-----	38
Figure 3-21. Horizontal component of magnetic field spectrum at end of haulageway in Farley panel-----	39
Figure 3-22. Spectrum obtained with an active dipole, 0.75 meters from phone line. Spectral resolution of 78.1 Hz-----	40
Figure 3-23. Voltage spectrum obtained between roof bolts located 15.2 meters apart, Farley panel. Spectral resolution of 78.1 Hz----	41
Figure 3-24. Voltage spectrum obtained between roof bolts located 15.2 meters apart, Farley panel. Spectral resolution of 3.91 Hz-----	42
Figure 3-25. Summary of rms noise voltage measured underground between roof-support-bolts in four mines-----	16
Figure 3-26. Comparison of logarithmic average of magnetic field strengths of three mines at six frequencies-----	43
Figure 3-27. Logarithmic average magnetic field strength summary-----	44
Figure 3-28. Comparison of EM noise levels near operating machinery from four mines-----	45
Figure 3-29. Comparison of EM noise levels along haulageways in four mines-----	46
Figure 4-1. APD, 10 kHz, vertical component, Cabin Creek-----	53
Figure 4-2. APD, 30 kHz, vertical component, Cabin Creek-----	54

LIST OF FIGURES (continued)

		<u>Page</u>
Figure 4-3.	APD, 70 kHz, vertical component, Cabin Creek-----	55
Figure 4-4.	APD, 130 kHz, vertical component, Cabin Creek-----	56
Figure 4-5.	APD, 160 kHz, vertical component, Cabin Creek-----	57
Figure 4-6.	APD, 250 kHz, vertical component, Cabin Creek-----	58
Figure 4-7.	APD, 500 kHz, vertical component, Cabin Creek-----	59
Figure 4-8.	APD, 1 MHz, vertical component, Cabin Creek	60
Figure 4-9.	APD, 2 MHz, vertical component, Cabin Creek	61
Figure 4-10.	APD, 6 MHz, vertical component, Cabin Creek	62
Figure 4-11.	APD, 14 MHz, vertical component, Cabin Creek-----	63
Figure 4-12.	APD, 32 MHz, vertical component, Cabin Creek-----	64
Figure 4-13.	APD, 10 kHz, vertical component, quiet time, Cabin Creek-----	65
Figure 4-14.	APD, 30 kHz, vertical component, quiet time, Cabin Creek-----	66
Figure 4-15.	APD, 130 kHz, vertical component, quiet time, Cabin Creek-----	67
Figure 4-16.	APD, 500 kHz, vertical component, quiet time, Cabin Creek-----	68
Figure 4-17.	APD, 1 MHz, vertical component, quiet time, Cabin Creek-----	69
Figure 4-18.	APD, 2 MHz, vertical component, quiet time, Cabin Creek-----	70
Figure 4-19.	APD, 6 MHz, vertical component, quiet time, Cabin Creek-----	71

LIST OF FIGURES (continued)

	<u>Page</u>
Figure 4-20. APD, 10 kHz, roof bolts-----	72
Figure 4-21. APD, 10 kHz, vertical component, Farley panel-----	73
Figure 4-22. APD, 30 kHz, vertical component, Farley panel-----	74
Figure 4-23. APD, 70 kHz, vertical component, Farley panel-----	75
Figure 4-24. APD, 130 kHz, vertical component, Farley panel-----	76
Figure 4-25. APD, 250 kHz, vertical component, Farley panel-----	77
Figure 4-26. APD, 500 kHz, vertical component, Farley panel-----	78
Figure 4-27. APD, 1 MHz, vertical component, Farley panel-----	79
Figure 4-28. APD, 2 MHz, vertical component, Farley panel-----	80
Figure 4-29. APD, 10 kHz, vertical component, Farley headpiece at the end of main belt haulage-	81
Figure 4-30. APD, 30 kHz, vertical component, Farley headpiece-----	82
Figure 4-31. APD, 70 kHz, vertical component, Farley headpiece-----	83
Figure 4-32. APD, 130 kHz, vertical component, Farley headpiece-----	84
Figure 4-33. APD, 160 kHz, vertical component, Farley headpiece-----	85
Figure 4-34. APD, 250 kHz, vertical component, Farley headpiece-----	86
Figure 4-35. APD, 500 kHz, vertical component, Farley headpiece-----	87

LIST OF FIGURES (continued)

		<u>Page</u>
Figure 4-36.	APD, 1 MHz, vertical component, Farley headpiece-----	88
Figure 4-37.	APD, 2 MHz, vertical component, Farley headpiece-----	89
Figure 4-38.	APD, 6 MHz, vertical component, Farley headpiece-----	90
Figure 4-39.	APD, 14 MHz, vertical component, Farley headpiece-----	91
Figure 4-40.	APD, 32 MHz, vertical component, Farley headpiece-----	92
Figure 4-41.	APD, 10 kHz, roof bolts-----	93
Figure 4-42.	Field strength excursions between 0.001% and 99% of the time as a function of frequency, vertical component, Cabin Creek	94
Figure 4-43.	Field strength excursions between 0.001% and 99% of the time as a function of frequency, vertical component, quiet time, Cabin Creek-----	95
Figure 4-44.	Field strength excursions between 0.001% and 99% of the time as a function of frequency, vertical component, Farley panel, April 17, 1973-----	96
Figure 4-45.	Field strength excursions between 0.001% and 99% of the time as a function of frequency, vertical component, Farley headpiece, April 19, 1973-----	97

ELECTROMAGNETIC NOISE IN ITMANN MINE

Two different techniques were used to make measurements of the absolute value of electromagnetic noise in an operating coal mine, Itmann No. 3 Mine, located near Mullens, West Virginia. The electromagnetic environment created by 250-volt-dc and 550- and 950-volt-ac machinery in two longwall panels was measured and is reported. One technique measures noise over the entire electromagnetic spectrum of interest for brief time periods. It is recorded using broadband analog magnetic tape, and the noise data is later transformed to give spectral plots. The other technique records noise amplitudes at several discrete frequencies for a sufficient amount of time to provide amplitude probability distributions.

The specific, measured results are given in a number of spectral plots and amplitude probability distribution plots.

Key words: Amplitude probability distribution; coal mine noise; digital data; electromagnetic communications; electromagnetic interference; electromagnetic noise; Fast Fourier Transform; Gaussian distribution; impulsive noise; magnetic field strength; measurement instrumentation; spectral density; time-dependent spectral density.

1. INTRODUCTION

This report gives data concerning electromagnetic noise in a coal mine that uses dc rail haulage power and ac-powered conveyor belt and longwall equipment. In this section, background information and a brief mine description are covered. In Section 2, measurement instrumentation is discussed. In Section 3, spectral plots of data are presented. In Section 4, amplitude probability distributions (APD) of magnetic-field noise are given.

Only representative samples of the total data measured are given in this report. Only a limited set of data-presentation formats have been used. If additional data, or data presentation in other formats, are required, please contact any of the authors. With specific permission of the Bureau of Mines, we will supply the additional data. A more complete description of the measurement systems used is given in the Robena Mine report [1] and the Grace Mine report [2].

1.1 Background

The need for reliable communication systems in mines is a long-standing problem. For emergency use, when all power in a mine is off, the residual electromagnetic noise is no problem. However, if a communication system were designed only for emergency use, it would have two serious drawbacks. First, it would not be ready for immediate use in an emergency; second, it would not be of any value during normal operations. Therefore, the Bureau of Mines decided to design a communication system that could be used for both emergency and normal operating conditions.

During operation, the machinery used in mines creates a wide range of many types of intense electromagnetic interference (EMI). This EMI is a major limiting factor in the design of a communication system. The work reported here gives the results of comprehensive measurements of this EMI in critical communication locations where miners extract coal as well as along haulageways.

There are several EMI parameters that can be measured: magnetic field strength, H; electric field strength, E; conducted current, I; and voltage, V, between two conductors. One parameter was emphasized, magnetic field strength. There are several reasons. First, electric field sensors are very insensitive at lower frequencies, and hence probably will not

be useful in any practical mine communication system. Second, at any air-earth interface, only the magnetic field is essentially undisturbed, while the electric field is severely reduced. Third, any currents will induce magnetic fields, and hence measurement of the magnetic field will directly sense currents. Fourth, power line voltages are propagated as transmission line phenomena, are directly related to transmission line currents, and hence to magnetic fields induced. Thus, measuring magnetic field strength gives a representative composite picture of noise from currents and voltages from most sources.

Although magnetic field strength measurements are emphasized here, even this one parameter is difficult to measure meaningfully. The IEEE definition [3] of magnetic field strength, H (magnitude of the magnetic field vector), is used in this report. The resultant magnetic field strength noise vector is a function of frequency, time, orientation, and location. Small variations in these parameters can cause several orders of magnitude difference in measured field strength.

1.2 Mine Description

The results and data presented in this report are based on measurements made on April 17 and 19, 1973, in the Itmann No. 3 Coal Mine located near Mullens, southwest of Beckley, West Virginia. The mine belongs to Consolidation Coal Company. The coal in this mine occurs in a narrow seam, approximately one meter thick, and is called "low-coal." The measurements were made in the two sections of the mine using the longwall mining technique. These sections were called Cabin Creek panel and Farley panel and were separated by about 1500 meters at the time of measurement. Overburden at Cabin Creek was

290 meters and at Farley was 440 meters. The mine has seven conventional, room-and-pillar sections; measurements were restricted to the longwall panels.

The mine uses 250 V dc trolley haulage to carry coal out of the mine, and ac powered conveyor belt haulage from the section to the trolley. All of the section longwall mining equipment is ac powered, with the exception of a dc-powered cable winch which was used occasionally to advance portions of the longwall equipment. The face and associated longwall equipment were 145 meters long. Each of the separate components of the longwall mining equipment was made by a different manufacturer, typically in England or Scotland. There were a total of six electric motors in the section ranging from 15 to 300 HP. The shear and face conveyor used 950 volts and the stage loader and hydraulic pumps used 550 volts. The step-down transformer supplying these voltages is kept 45 to 230 meters back from the face, and is supplied with 13,200 volts.

Vertical clearance for personnel passage in Cabin Creek panel was limited to the 1.0 meter left by the extracted coal. In Farley panel, clearance was increased to 1.2 meters by the removal of some shale in the personnel passageways.

Acoustical noise at the longwall face may be high enough to seriously degrade voice communication systems.

2. MEASUREMENT INSTRUMENTATION

Two measurement techniques were used. In the first technique used a large portion of the spectrum is covered as a "snapshot" at one relatively short period of time. In three-dimensional form, several such "snapshots" can show how drastically a signal varies, not only with frequency, but also with time. In the second technique, variations over a 20-minute time interval are measured at one frequency. Usually, a set of twelve different frequencies was used. Both techniques were used to measure two orthogonal components of magnetic field strength. This was done either by using two systems simultaneously or by varying the orientation of one system; both techniques were used in as many different locations as possible.

With the exception of the electric dipole spectral plots and the roof-bolt APD's, all measured noise is reported in absolute quantities (instead of relative) to allow others to make effective use of the data. For the magnetic field strength measurements, the NBS field calibration site [4] was used with each complete measurement system to assure correct calibration.

A complication to making these measurements is the mine environment, which is generally humid, dusty, poorly lighted, and potentially explosive. In Itmann Mine, the restriction caused by the one meter clearance in the passageways caused a significant reduction in the total number of locations where measurements could be made. Battery-operated, dust-protected, permissible gear was used for most of our portable measuring equipment.

There are two types of noise recorded in the spectral plots, and hence two different magnetic field strength parameters are required, H and H_d . Results are given as the rms value of one component of magnetic field strength, H , versus frequency for

discrete frequencies, or as one component of magnetic-field-strength spectrum density level [3], H_d , versus frequency for broadband noise in the spectral plots. In the amplitude probability distributions, results are given as the rms value of one component of magnetic field strength versus percent of time this value is exceeded. The APD gives the distribution of the actual instantaneous values only as far as the measurement-system detector bandwidth will allow the detector to follow the time variations of the actual magnetic field. (In this context, noise envelope is sometimes used.) Thus, the results are applicable for a communication receiver whose bandwidth is similar to the measurement-system detector bandwidth.

Three measurement systems were used to make measurements underground. The three systems are described in the block diagrams shown in figures 2-1, 2-2, and 2-3. For a detailed description of these systems, see two previous reports [1,2]. There are some differences in the systems used in Itmann Mine from the systems used in Robena #4. The systems used in Itmann are the same ones used in Grace.

The first system measures data for spectral plots and is fully permissible and portable. The second system measures data for statistical descriptions of time variations, most commonly amplitude probability distribution; it is also permissible. The third system is not permissible but is portable (with considerable effort); it records data for both spectral plots and statistical presentations.

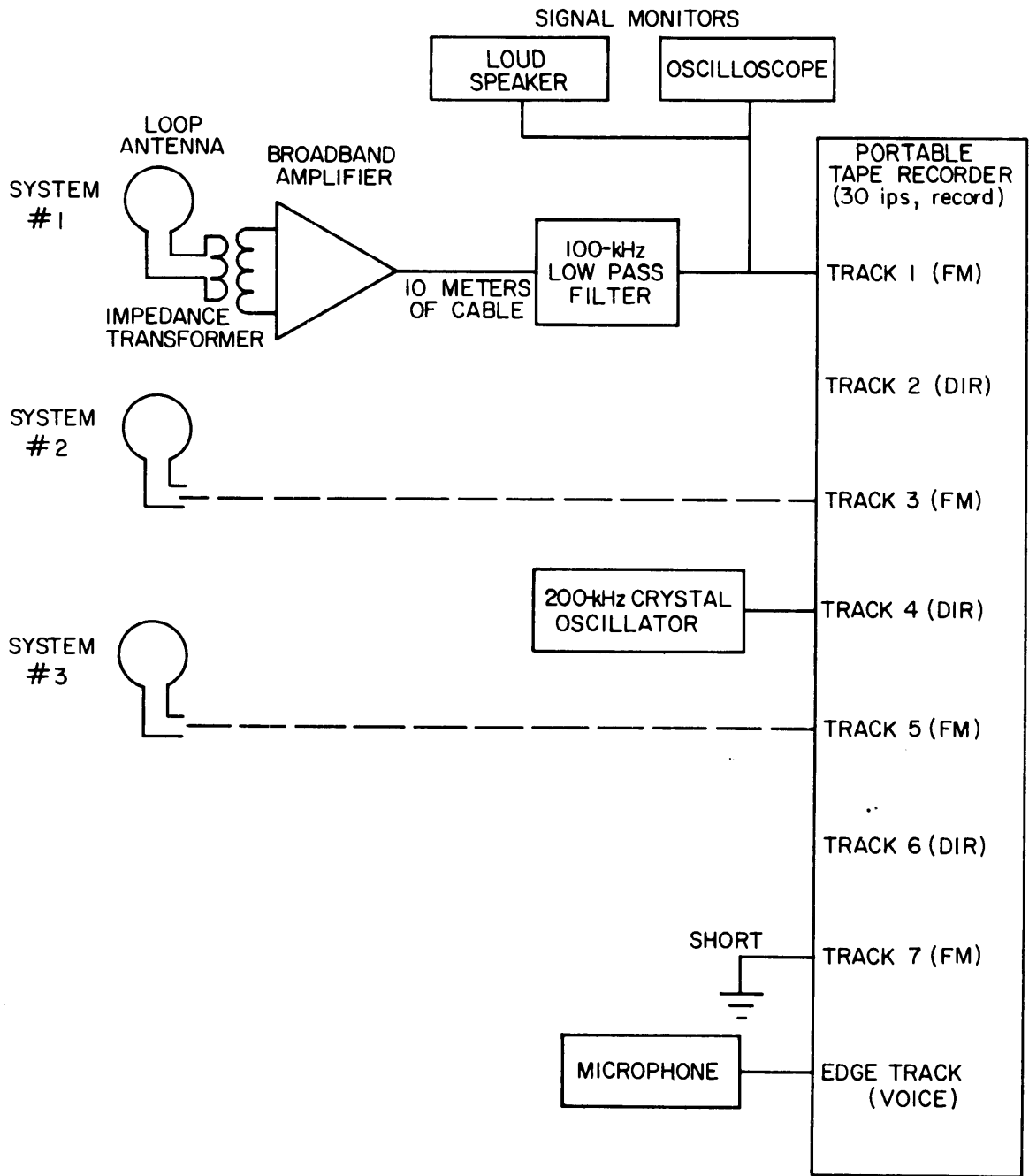

Figure 2-1 Block diagram of portable instrumentation. FM tracks are used to record from 40 Hz to 100 kHz; direct tracks are used from 3 kHz to 320 kHz. Systems 2 and 3 are identical to system 1. When the direct tracks are used, the 100-kHz low pass filters are eliminated, and the amplifier bandwidth is increased from 100 kHz to 300 kHz. The microphone is used for occasional vocal comments by the operator.

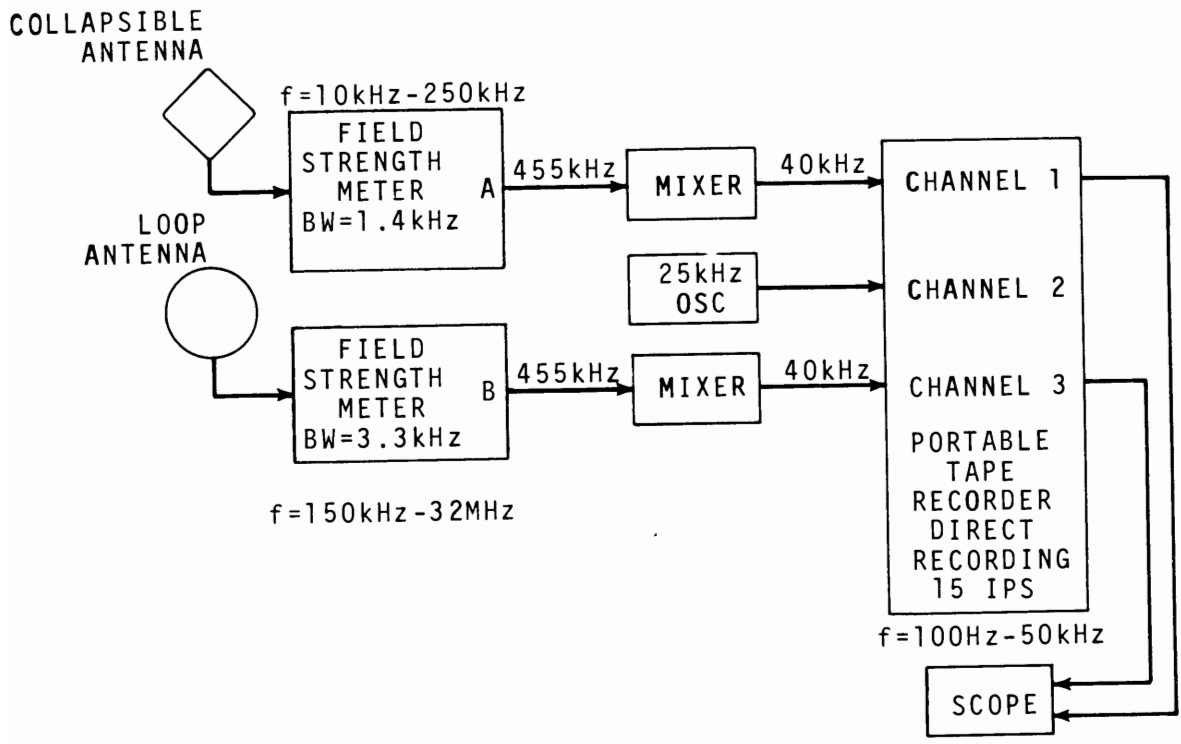

Figure 2-2 System for field recording data to obtain amplitude probability distributions.

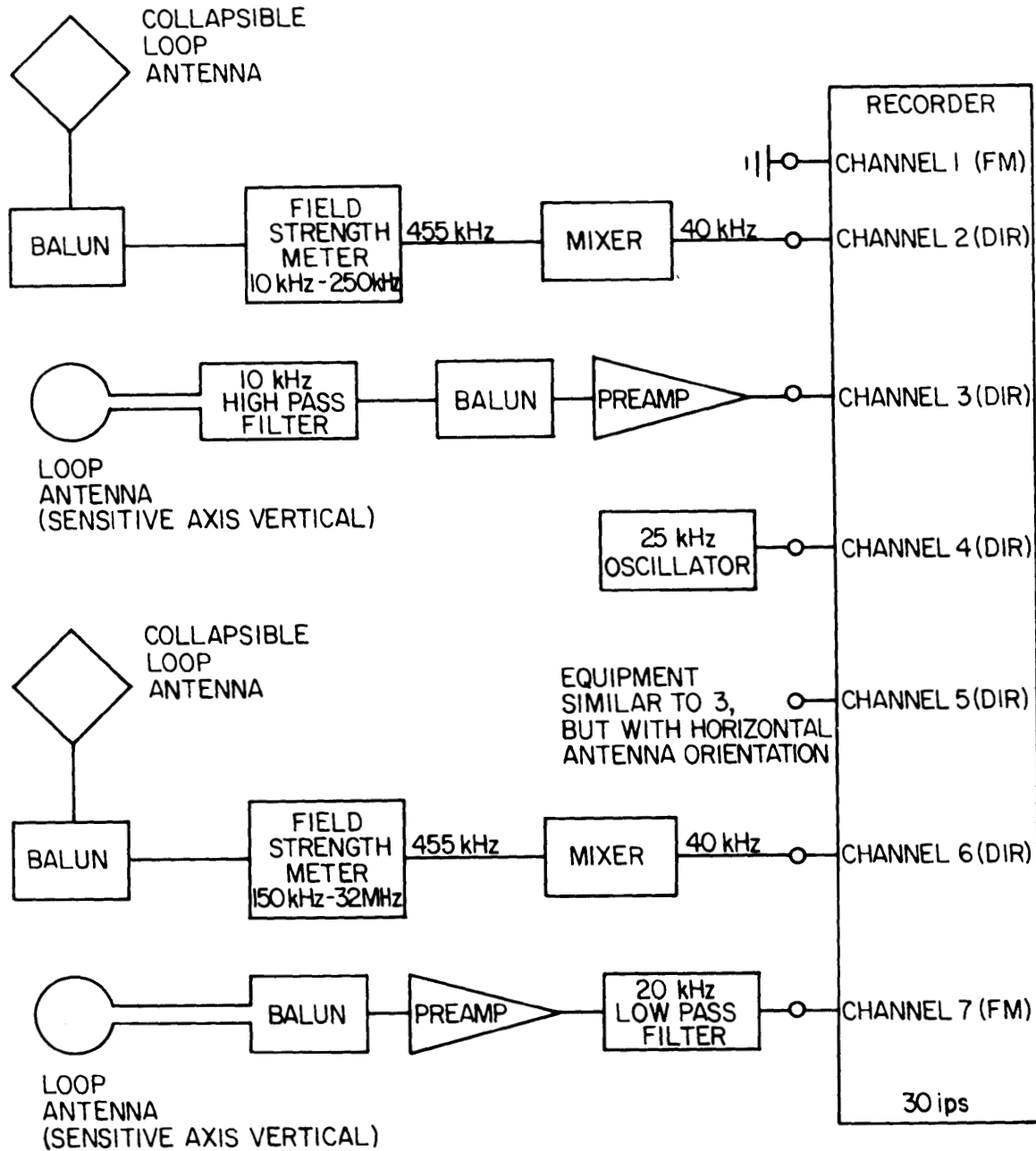

Figure 2-3 Block diagram of laboratory recording system modified for field use.

3. SPECTRUM MEASUREMENT RESULTS

3.1 Introduction and Uncertainties

In this section of the report, spectrum plots are presented and discussed. Most of these plots present magnetic field strength up to 100 kHz. Measurements were made at many different locations and results can be used to characterize electromagnetic noise levels generated by most fixed and mobile equipment used in this mine. Some plots give data to 3 kHz, 20 kHz, and 230 kHz.

The spectra to 100 kHz, to 3 kHz, and to 20 kHz have uncertainties of ± 1 dB over the following portions of the spectra. The 100 kHz spectra are valid either from 1 to 100 kHz or 10 kHz to 100 kHz as stated or shown. The 3 kHz spectra have the ± 1 dB uncertainty from 100 Hz to 3 kHz. Between 40 Hz and 100 Hz the uncertainty is ± 6 dB. The 20 kHz spectra have an uncertainty of ± 1 dB from 750 Hz to 20 kHz.

The spectra shown to 230 kHz have an uncertainty of ± 2 dB from 3 kHz to 180 kHz.

3.2 Antenna Sites

Figure 3-1 is a map of Cabin Creek panel as it was on April 17, 1973, the first day measurements were made. The shear would operate back and forth across the face, as the mining operation advanced. The recording equipment was set up in the dinner man hole, and the antennas were deployed in the locations labeled A and B.

On the second day measurements were made in Farley panel, which has similar equipment but was arranged in the mirror image of Cabin Creek panel. The layout can be determined by looking at figure 3-1 through the back side of the drawing. No separate map is given for Farley panel.

3.3 Electromagnetic Noise Spectrum Results

3.3.1 Interpretation

When reading values from the spectra in this report, keep the following points in mind:

1. Field strength values above the upper roll-off frequency and below the lower roll-off frequency are not calibrated and are therefore not shown on the spectra.
2. The correct units for the spectral peaks are microamperes per meter ($\mu\text{A}/\text{m}$).
3. The broadband noise between spectral peaks is as seen by a receiver having the same bandwidth as the Fast Fourier Transform (FFT) spectral resolution bandwidth used to compute the spectrum. The correct units for the background noise between peaks are microamperes per meter per square root x hertz $[(\mu\text{A}/\text{m})/\sqrt{x \text{ Hz}}]$, where x is the spectral resolution of the FFT (x equals 78.1 Hz for the 1-to-100-kHz graphs).

An easy way to obtain the spectral density per (one) root hertz for broadband noise is to subtract the required number of dB, remembering that the units have now changed to $(\mu\text{A}/\text{m})/\sqrt{\text{Hz}}$. For spectra with a resolution bandwidth of 78.1 Hz, subtract $10 \log_{10} (78.1)$ or 18.93 dB.

The Appendix gives the code key used in determining the meaning of the numbers in the header block at the top of each spectrum. The resolution bandwidth is also given on the ordinate of the plots.

3.3.2 Cabin Creek Panel

Figure 3-2 upper curve, shows the magnetic field noise spectrum from 1 kHz to 100 kHz received at the antenna location identified as A (in figure 3-1). The antenna sensitive

axis was vertical. Location A is near the dinner man hole, 10 meters from the end of the face, and is a busy area in the section. The lower curve in this, and in following figures, is the receiving system noise. It is included to indicate frequency ranges in which system noise may predominate. The lower curve is obtained by replacing the loop antenna with a dummy antenna. This figure shows data from 1 kHz to 100 kHz from one system and from 10 kHz to 100 kHz from another system that had lower system noise. An obvious feature in figure 3-2 is a signal at 17.8 kHz. This is from the U.S. Navy transmitter NAA located in Cutler, Maine. With the exception of one shallow location in a hardrock mine, this is the only underground mine location where reception of a distant VLF station occurred. This strong signal from NAA in a coal mine under this large overburden (290 meters) is very unusual. The mine-generated noise shown on figure 3-2 extends to 100 kHz at the -20 dB relative to 1 μ A/m level. Between 60 and 75 kHz, there is a dip in amplitude of 8 dB or more. Figure 3-3 shows the expanded spectrum at location A, ten meters from the end of the longwall face, with the mine operating. Figure 3-3 shows a noise spectrum dominated by powerline harmonics of 60 Hz.

Figure 3-4 was measured at location B, five meters from the end of the longwall face, with the mine in operation. The noise spectrum at location B, with the antenna axis vertical, has about the same shape as the spectrum at location A, but is 4 to 10 dB higher. The spectra recorded at B, as at location A, shows a rise in noise level from about 80 kHz to 100 kHz. Figure 3-5 shows the expanded spectrum at location B. The spectrum taken with the antenna sensitive axis horizontal gives 4 to 10 dB less noise than with the sensitive axis vertical. Figure 3-6 shows the expanded spectrum at location B later, during the second shift, with the mine in full operation. Figure 3-6 is included because of the high level (108 dB relative to 1 μ A/m) of 60 Hz noise.

Figure 3-7 shows the noise spectrum measured at Cabin Creek panel during the quiet time between shifts at location B. This spectrum is about 10 to 20 dB quieter than when the mine is in full operation. Figure 3-8 shows the expanded spectrum measured at location B between shifts. The 60 Hz noise here is 46 dB lower than when the mine was in full operation during the second shift.

3.3.3 Farley Panel

Figure 3-9 shows the spectrum measured ten meters from the end of the longwall face in Farley panel. Farley panel was the mirror image of Cabin Creek. The measurement location for figure 3-9 corresponds to location A on figure 3-1. While the noise in Farley between 10 kHz and 20 kHz is sometimes as much as 10 dB higher than in Cabin Creek, generally, the noise in Farley may be considered lower than the noise in Cabin Creek panel. Neither the signal from NAA nor the increase in noise between 80 and 100 kHz show up in Farley. Figure 3-10 shows the expanded spectrum at location A, Farley panel, with the mine in operation. In Farley, the 60 Hz noise is 24 dB lower, the 360 Hz noise is the same amplitude, and most other harmonics are lower by as much as 15 dB, than at Cabin Creek.

Figure 3-11 shows the spectrum measured at Farley panel, ten meters from the end of the longwall miner, during the quiet time at lunch hour. Only the hydraulic pump, associated with the 134 roof jacks, was running. This pump was left running much of the time. The spectrum is essentially the same as shown in figure 3-9 when the mine was in operation. Figure 3-12 shows the expanded spectrum at Farley during lunch hour. The noise at 60 Hz is 4 dB lower during lunch hour. With some minor variation, the remainder of the expanded spectrum is about the same during lunch hour as during mine operation.

Figures 3-13 and 3-14 show the spectrum recorded in Farley panel, ten meters from the end of the longwall face. The ac-powered conveyor belt was just starting up. Evident on figure 3-13 is powerline related noise out to 100 kHz, occurring with broad peaks about every 20 kHz. This noise signature is probably associated with an ac motor starting, and is probably of correspondingly short duration. Figure 3-14 shows 7 dB higher 60 Hz noise than with the mine in operation (figure 3-10). Induction motors typically require about 2.5 times (8 dB) more current to start than to run. Probably the increased 60 Hz noise comes from the increased starting current being drawn by the starting of the conveyor-belt motor.

Data taken with the third system in Farley Panel are shown in the following figures. Figure 3-15 shows a spectrum from 0.8 to 20 kHz taken about three meters from an operating shear on the longwall machine. Figure 3-16 shows typical noise at the end of the rail haulage, about 200 meters from the longwall face. Figures 3-17 and 3-18 show two components of noise generated by an unidentified piece of machinery. Figure 3-19 shows an expanded (to 20 kHz) spectra of figure 3-17. There were strong cw signals at frequencies higher than our systems were normally operated; however, two illustrations are shown at frequencies higher than the system's calibration is valid. One signal shown in figures 3-20 and 3-21 is at 202.5 kHz; it may be a control signal specific to this mine. It did generate higher harmonics that were detected with other equipment.

3.4 Miscellaneous Measurements

3.4.1 Electric Field

An active dipole, 1.93 meters long, was used as a sensor on the second day while in Farley panel. This dipole has not

been calibrated, nor have any system nonlinearities in gain vs. frequency been removed by a correction curve. Therefore, all field strength information is only qualitative. Figure 3-22 shows unprocessed data results obtained with the dipole ends pointed parallel with the drift and 0.75 meters from the phone line. Measurements taken with the dipole pointed across (perpendicular to) the drift gave fields that were 10 to 20 dB stronger than those shown in figure 3-22. Fields were 20 to 30 dB weaker when the dipole was 4 meters from the phone line. This indicates the noise was coming from the phone line. The electric field data shown in figure 3-22 was taken simultaneously with the magnetic field data in two previous figures, 3-13 and 3-14. The mine conveyor belt was just starting up. There is some similarity in the general shape of the two 1 kHz to 100 kHz spectra shown in figures 3-13 and 3-22.

Because of the relative nature of the electric field measurements, the principal conclusions that can be drawn are restricted to: (1) an electric noise field exists in Farley panel; (2) it is primarily powerline related, similar to the magnetic field noise; (3) the electric noise field is maximum for horizontal dipole orientation across (perpendicular to) the drift; and (4) the source of the electric field noise appears to be the phone line.

3.4.2 Measurements of Voltage Between Roof Bolts

A single roof-support-bolt measurement was performed at Farley panel on the second day. The separation between the two bolts was 15.2 meters, and the voltage was measured using non-shielded copper wire clipped to the bolts. Figures 3-23 and 3-24 show the resulting spectra. No receiver system noise curves are available for these spectra. It is not possible to say that the voltage measured between bolts was induced by any

single mechanism. It may be any combination of electric field and magnetic field acting on the copper wires connected to the bolts, as well as by any potential produced by current flow between the bolts.

3.5 Intercomparison of Different Mines

3.5.1 Roof Bolt Voltage Intercomparison

Figure 3-25 shows a summary table of the rms noise voltage measured between roof bolts of various spacings, in four mines.

<u>Mine</u>	<u>Frequency (Hz)</u>	<u>Roof Bolt Voltage dB Relative to 1 Vrms</u>	<u>Logarithmic Average Voltage</u>
Itmann (coal)	1080	-46	-53
	2160	-60	
McElroy (coal)	1080	-62	-64.5
	2160	-67	
Grace (hardrock)	1080	-68	-68
	2160	-68	
Robena (coal)	1080	-80	-81.5
	2160	-83	

Figure 3-25. Summary of the rms noise voltage measured underground between roof-support-bolts in four mines.

The logarithmic average is the arithmetic average of the dB values. Two frequencies within the voice baseband were chosen for comparison: 1080 Hz, the third harmonic of 360 Hz, and 2160 Hz, the sixth harmonic of 360 Hz. The results show that the logarithmic averages for these two frequencies give the highest voltage (-53 dB with respect to 1 V rms) for Itmann, and the lowest value for Robena (-81.5 dB with respect to 1 V rms). Possibly a factor contributing to the low roof bolt voltage in Robena, is the fact that the bolts were on a

line perpendicular to the haulageway. In Itmann, the bolts were on a line along the haulageway. In McElroy and Grace this distinction could not be made.

3.5.2 Summary of 1 kHz to 3 kHz Data

Figure 3-26 is a summary of magnetic field strength at powerline harmonic frequencies observed within Itmann (ac-powered longwall), Robena (all 600 v dc) and the Grace (diesel-powered haulage) mines. Plotted are the dB averages of six powerline harmonics. This logarithmic average masks the highest single value. Average fields at five locations in Itmann are plotted as a function of distance from the nearest current-carrying cable or wire. The six frequencies chosen are between 1020 Hz and 2940 Hz and are either the third through eighth harmonic of 360 Hz, or the highest adjacent powerline harmonic.

The logarithmic average of noise from 1 kHz to 3 kHz in Cabin Creek panel of Itmann was 40 dB relative to $1 \mu\text{A}/\text{m}$ with the mine in operation. The noise was 7 dB less between shifts. The noise in Farley panel was 28 dB (as measured with the third system, first day) and 29 dB (as measured with the first system, second day) relative to $1 \mu\text{A}/\text{m}$ during operation, and was also 29 dB during lunch hour. The noise in Farley was 5 dB higher during the time the conveyor belt was starting up than while running, and 8 dB higher measured 70 meters back from the face, near the end of the dc-powered rail haulage. This last finding is consistent with the observation that, in general, dc machinery is noisier than ac machinery.

Figure 3-27 is a summary of magnetic field strength over the same frequency region as measured in the McElroy Coal Mine [7] (ac-powered continuous miner and head loader, dc-powered shuttle cars and trolley).

A comparison of the magnetic noise from 1 kHz to 3 kHz in the four mines shows:

1. Robena is noisiest, McElroy is next, followed by Grace and Itmann, which are about equal.
 - a. The highest logarithmic average of section noise measured one meter from a cable in McElroy is 15 dB relative to 1 μ A/m (at the power center). The noise is 16 dB higher at the "air split" on the haulageway in Robena, and 21 dB higher at the car pull in operation in Robena than the 15 dB value in McElroy.
 - b. The highest logarithmic average of haulageway noise measured 2 meters from a cable in McElroy is 7 dB stronger than the noise measured 2 meters from a load-haul-dump in Grace. The Grace noise is equal to the noise measured in Cabin Creek panel in Itmann.
 - c. For a given constant distance from the current-carrying cable in each of the four mines measured, the maximum logarithmic average noise between 1 kHz and 3 kHz varies over a rather small range. For example, at the 2 meter distance from the cable (or noise source), the highest noise was 48 dB (in McElroy), and the lowest was 40 dB (in Grace and Itmann). The range of values is only 8 dB. Part of the reason for this low spread may be due to the parameter chosen for measurement, the logarithmic average. This average masks the peak value, which is dominant in causing interference to a broadband system.

3.5.3 Intercomparison of 3 kHz to 200 kHz Data

Comparative spectra from 3 kHz to 200 kHz from four mines are shown in figures 3-28 and 3-29. The Robena curve is only calibrated to 100 kHz.

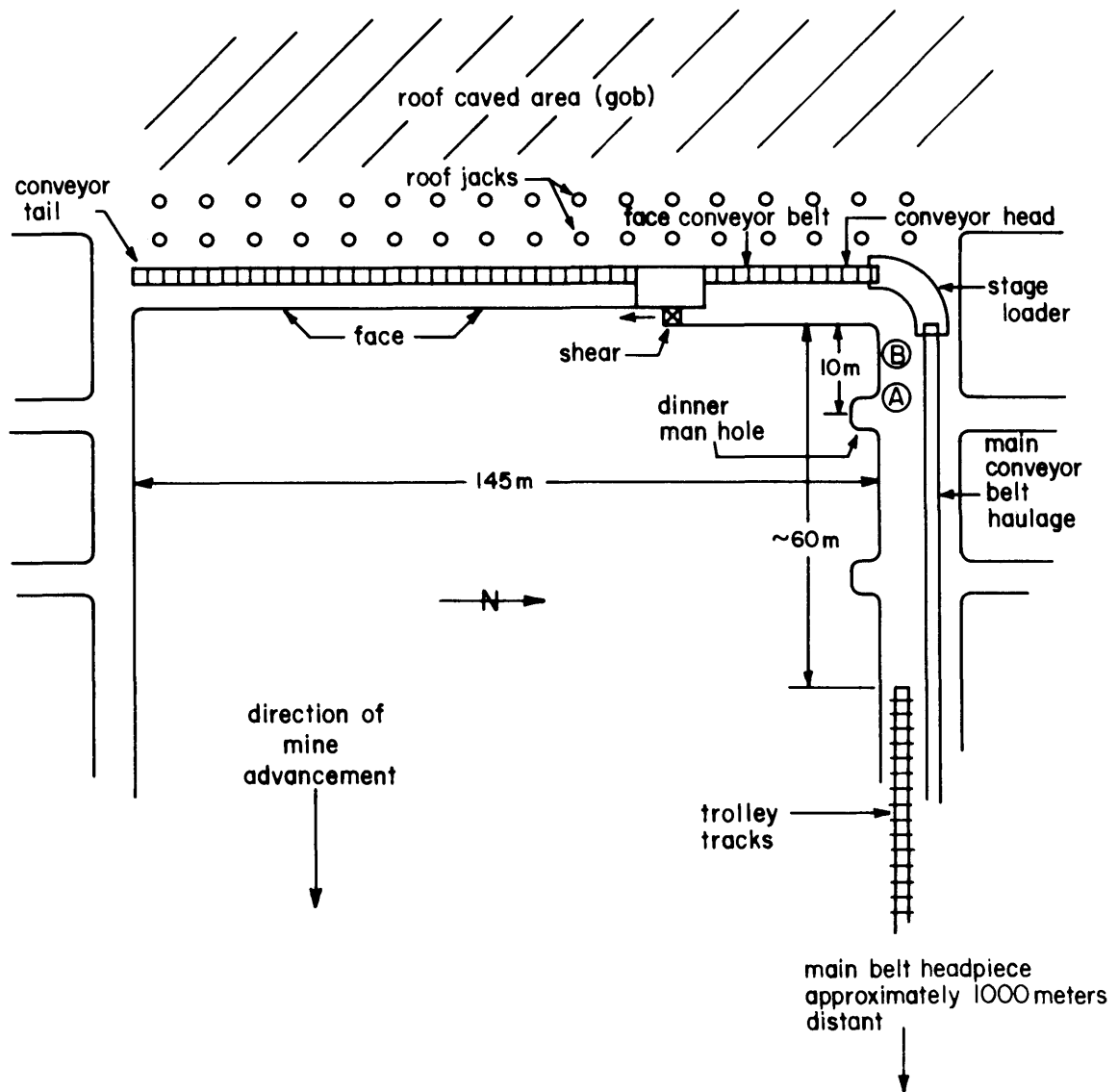

Figure 3-1 Map of Itmann Coal Mine, Cabin Creek panel long-wall mining section. Farley panel is a minor image of this section.

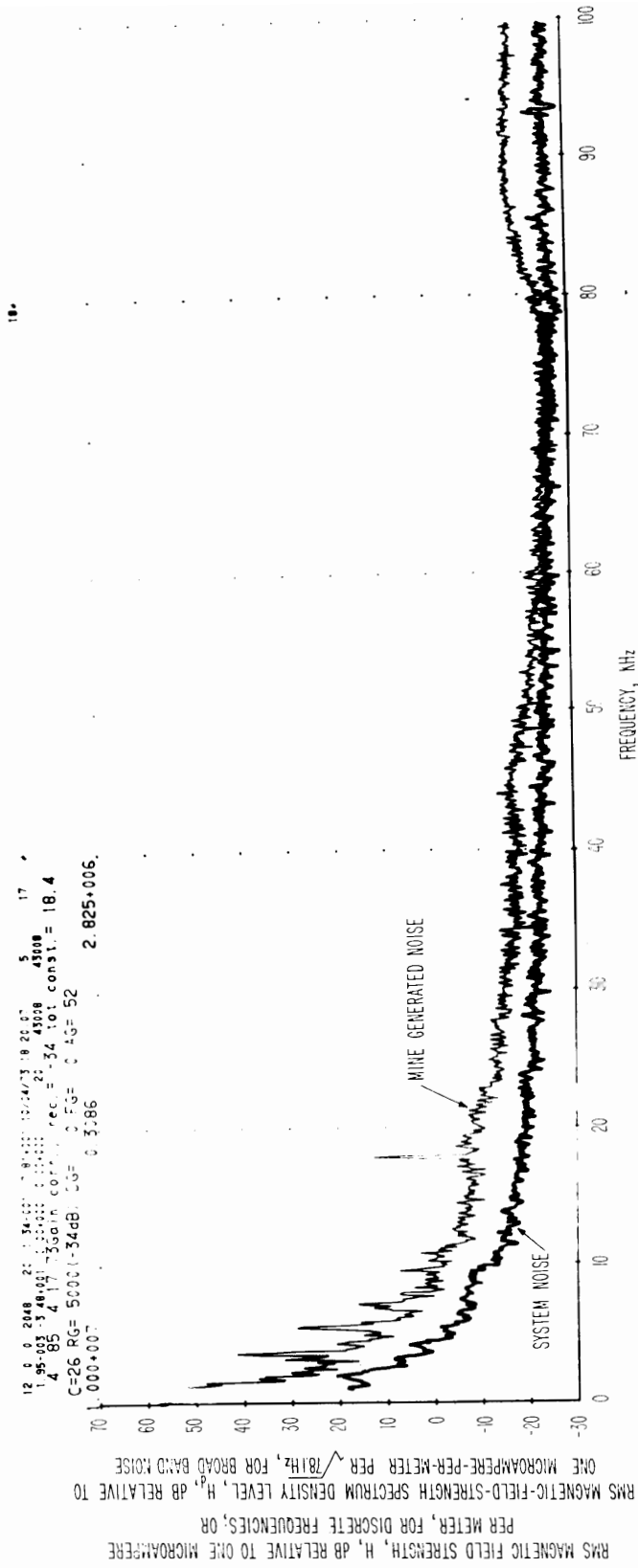

Figure 3-2 Composite spectrum of magnetic field strength obtained on a loop antenna 1 kHz to 100 kHz, Itmann Mine, Cabin Creek panel, 10 meters from the end of the long-wall face, mine in operation, antenna sensitive axis vertical, 12:10 p.m., April 17, 1973. Spectral resolution is 78.1 Hz.

12 2 5 2148 20 2.69+000 3.91+000 15/13/74 22:11:14 22 112
 1.95+013 -3.38+001 0.00+000 0.00+000 20 43:08 43:08
 33 113 4 17 73Gain corr., rec. = -14 tot const. = 38.4
 C=42 RG= 500 (-14dB) DG= 0 FG= 0 AG= 52
 1.000+010 0.3086 7.766+009

RMS MAGNETIC FIELD STRENGTH, H, dB RELATIVE TO ONE MICROAMPERE
 PER METER, FOR DISCRETE FREQUENCIES; OR
 RMS MAGNETIC-FIELD-STRENGTH SPECTRUM DENSITY LEVEL, H, dB RELATIVE TO
 ONE MICROAMPERE-PER-METER PER $\sqrt{391}$ Hz, FOR BROAD BAND NOISE

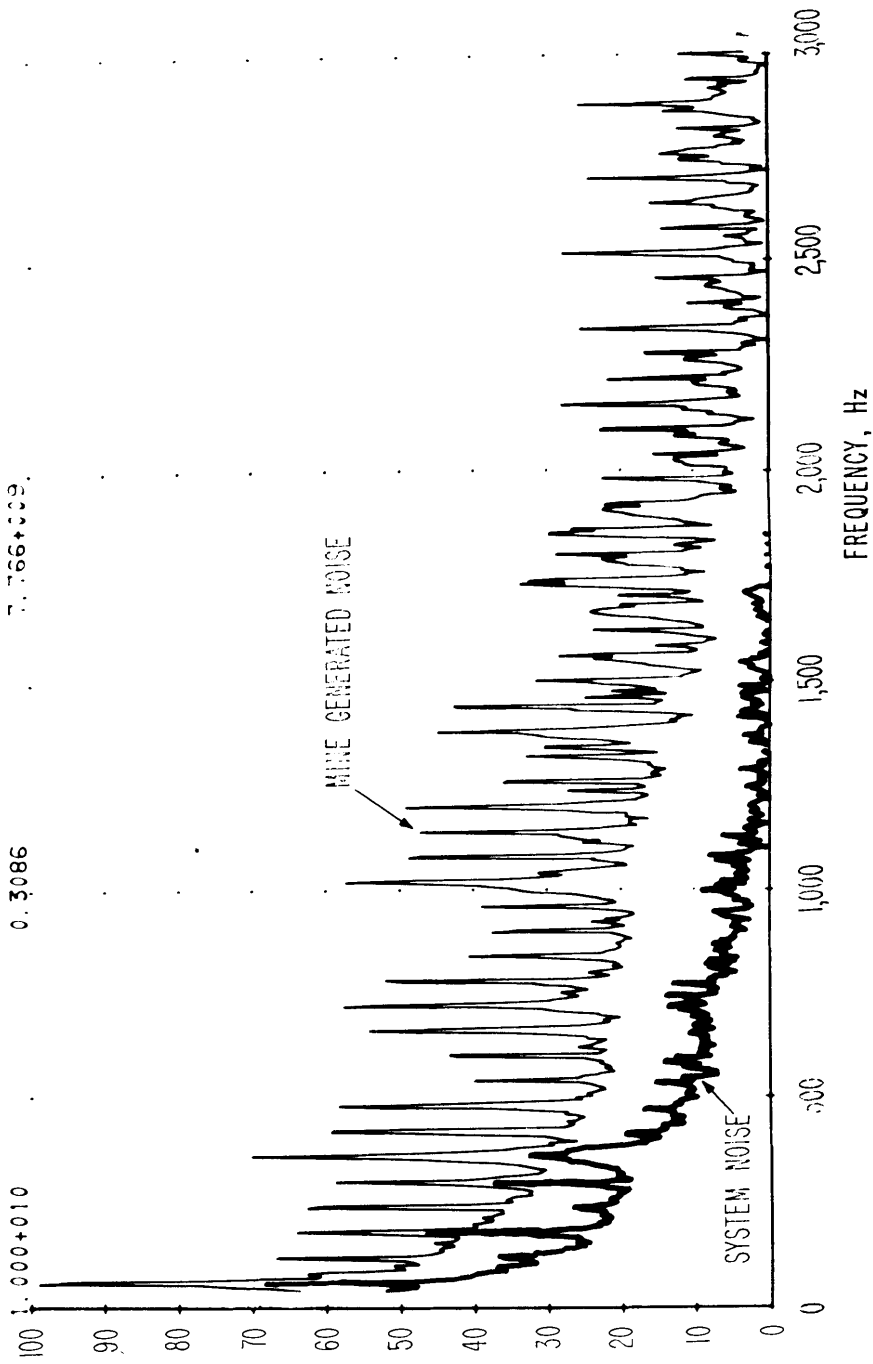

Figure 3-3 Spectrum of magnetic field strength obtained on a loop antenna 40 Hz to 3 kHz, Itmann Mine, Cabin Creek panel, 10 meters from the end of the long-wall face, mine in operation, antenna sensitive axis vertical, 12:10 p.m., April 17, 1973. Spectral resolution is 3.91 Hz.

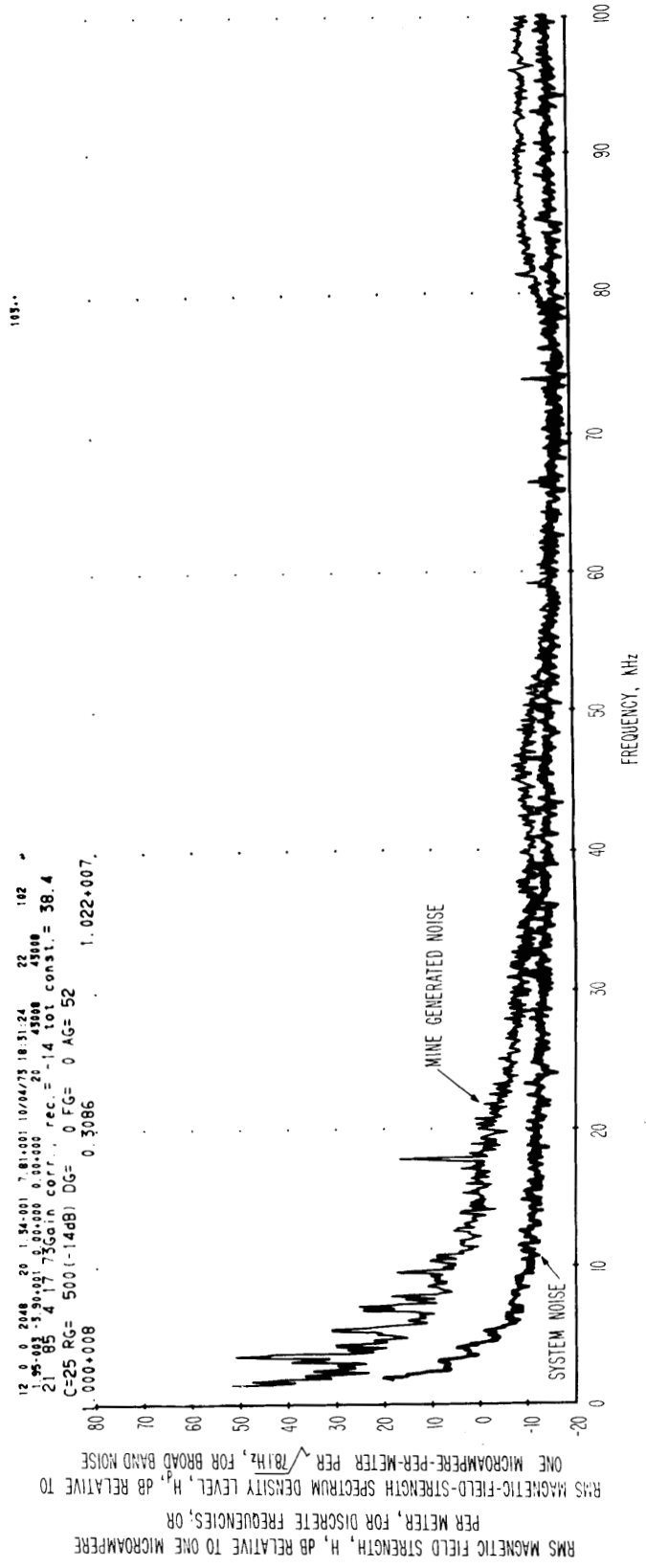

Figure 3-4 Spectrum of magnetic field strength obtained on a loop antenna 1 kHz to 100 kHz, Itmann Mine, Cabin Creek panel, 5 meters from the end of the long-wall face, mine in operation, antenna sensitive axis vertical, 3:17 p.m., April 17, 1973. Spectral resolution is 78.1 Hz.

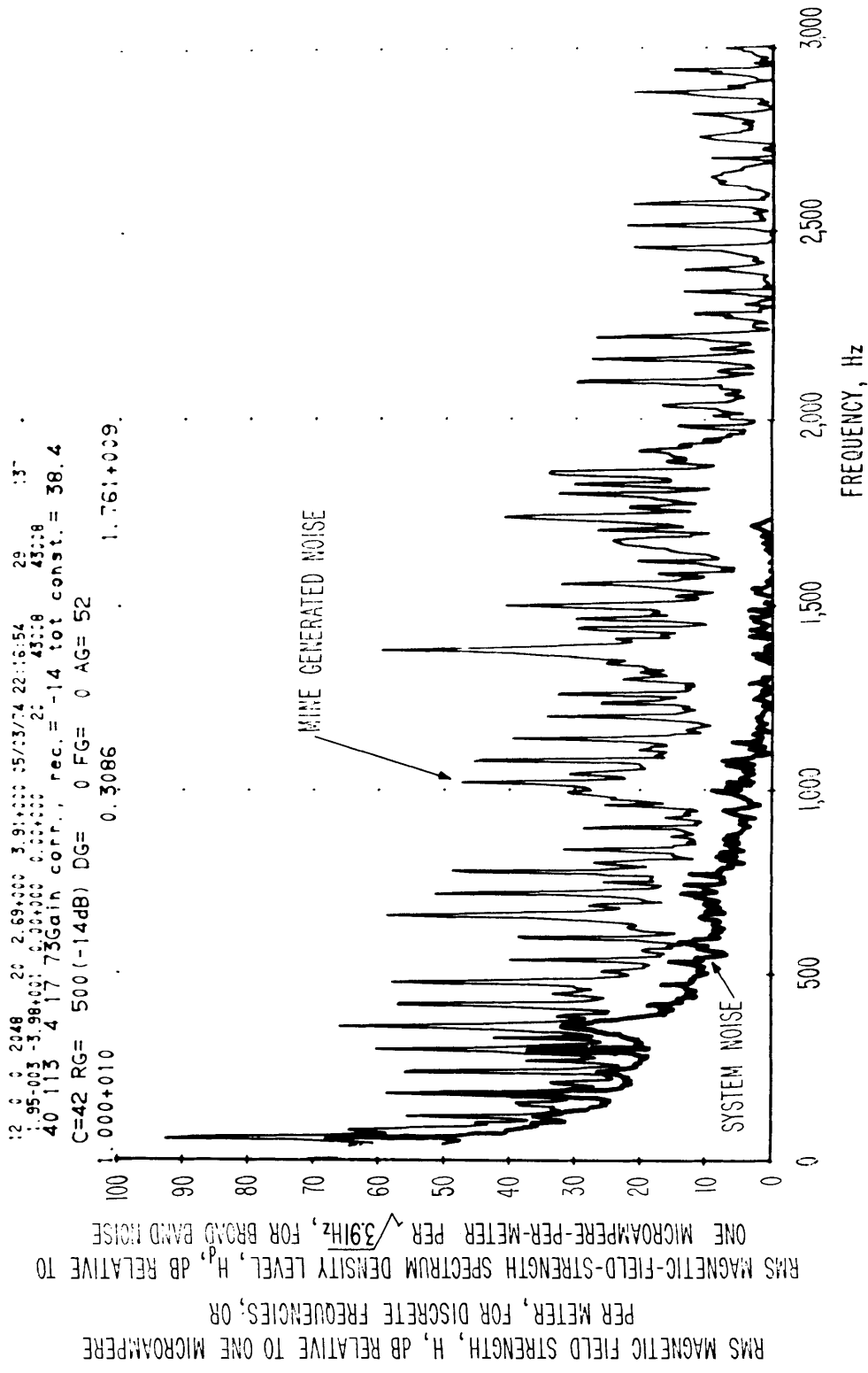

Figure 3-5 Spectrum of magnetic field strength obtained on a loop antenna 40 Hz to 3 kHz, Itmann Mine, Cabin Creek panel, 5 meters from the end of the long-wall face, mine in operation, antenna sensitive axis vertical, 3:17 p.m., April 17, 1973. Spectral resolution is 3.91 Hz.

12 5 2048 20 2.69+000 3.91+000 15/13/74 22:21:29 34 162
 1.95-003 -3.9+001 0.00+000 0.00+000 20 43:08 43:08
 45 113 4 17 73Gain corr., rec.= -6 tot const.= 46.4
 C=42 RG= 200 (-6dB) DG= 0 FG= 0 AG= 52
 0.000+011 0.3086 7.144+010.

RMS MAGNETIC FIELD STRENGTH, H, dB RELATIVE TO ONE MICROAMPERE
 PER METER, FOR DISCRETE FREQUENCIES; OR
 RMS MAGNETIC-FIELD-STRENGTH SPECTRUM DENSITY LEVEL, H_p, dB RELATIVE TO
 ONE MICROAMPERE-PER-METER PER $\sqrt{3.91}$ Hz, FOR BROAD BAND NOISE

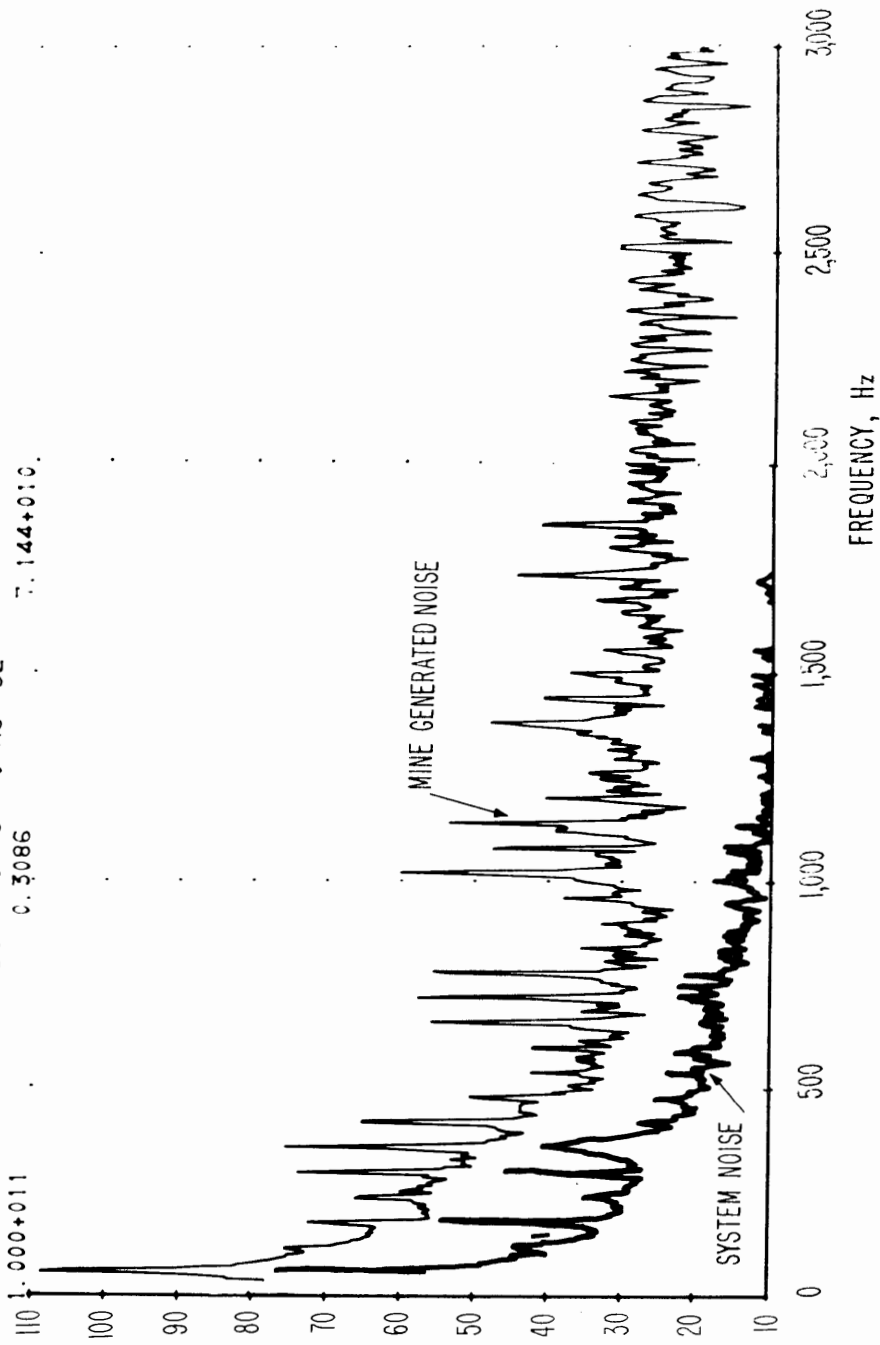

Figure 3-6 Spectrum of magnetic field strength obtained on a loop antenna 40 Hz to 3 kHz, Irons Mine, Cabin Creek panel, 5 meters from the end of the long wall face, second shift in full operation, antenna sensitive axis vertical, 4:55 a.m., April 17, 1973. Spectral resolution is 3.91 Hz.

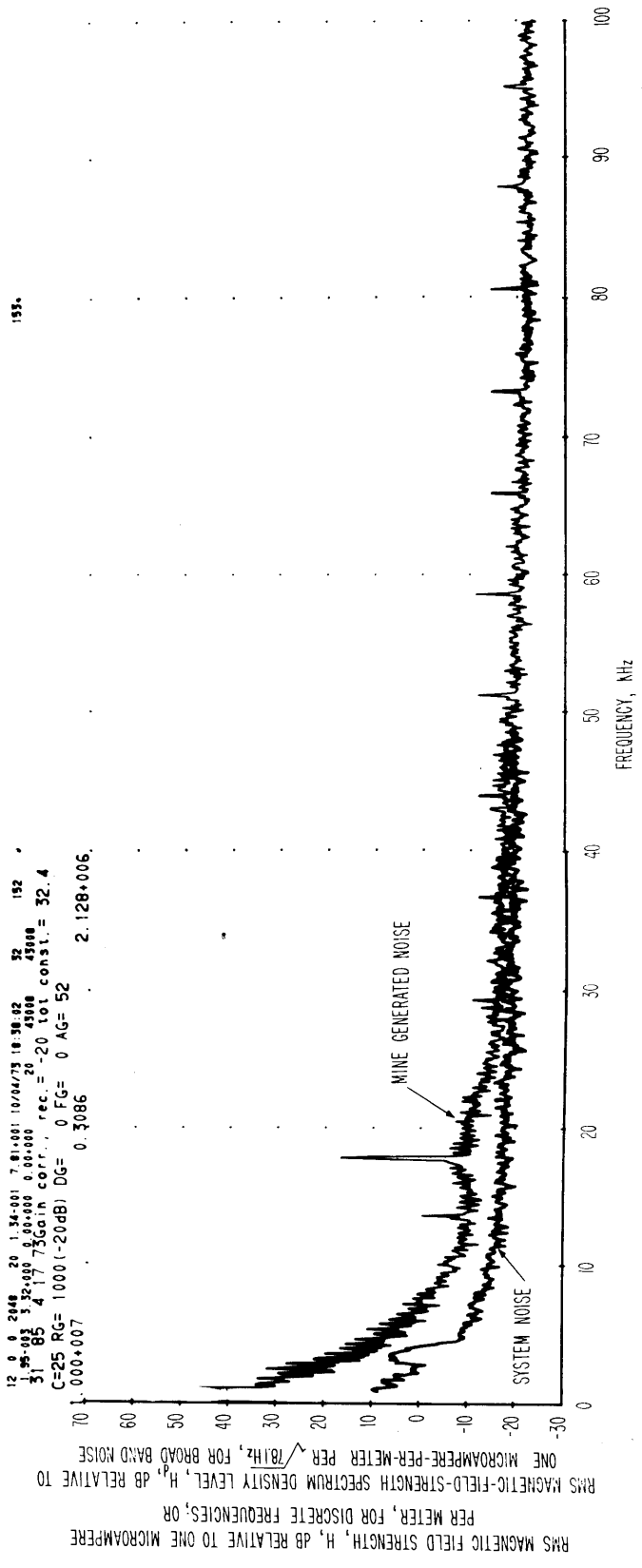

Figure 3-7 Spectrum of magnetic field strength obtained on a loop antenna 1 kHz to 100 kHz, Itmann Mine, Cabin Creek panel, 5 meters from long-wall face, quiet between shifts, antenna sensitive axis vertical, 3:57 p.m., April 17, 1974. Spectral resolution is 78.1 Hz.

12 0 0 2048 20 2.69+000 3.91+000 55/33/74 22:19:46 33 157
 1.95+003 -4.47+001 0.00+000 0.00+000 20 4308 4308
 44 113 4 17 75Gain corr., rec. = -20 tot const. = 32.4
 C=42 RG= 1000 (-20dB) DG= .0 FG= 0 AG= 52
 1.000+008 0.3086 3.252+007.

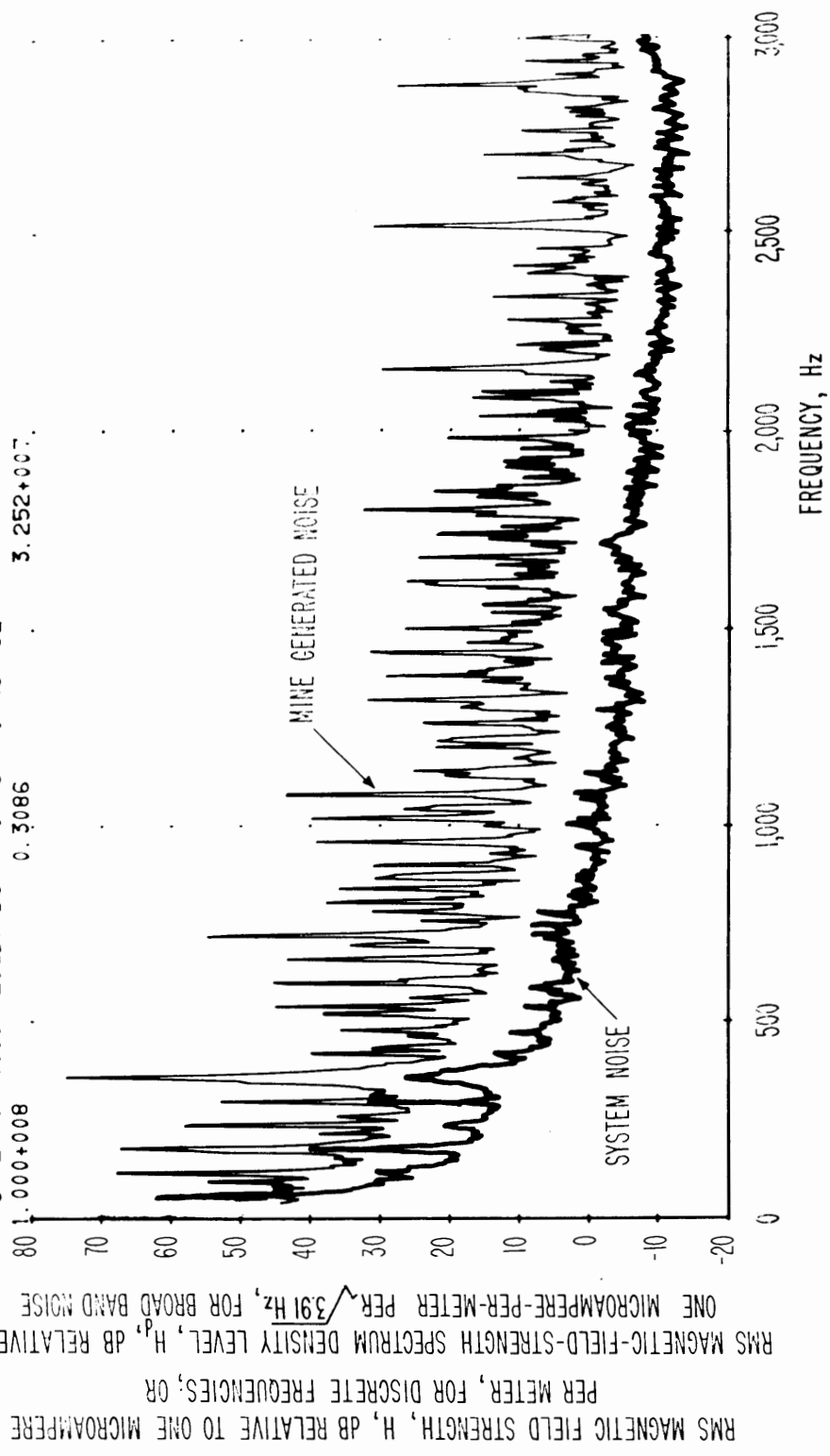

Figure 3-8 Spectrum of magnetic field strength obtained on a loop antenna 40 Hz to 3 kHz, Itmann Mine, Cabin Creek panel, 5 meters from long-wall face, quiet between shifts, antenna sensitive axis vertical, 3:57 p.m., April 17, 1974. Spectral resolution is 3.91 Hz.

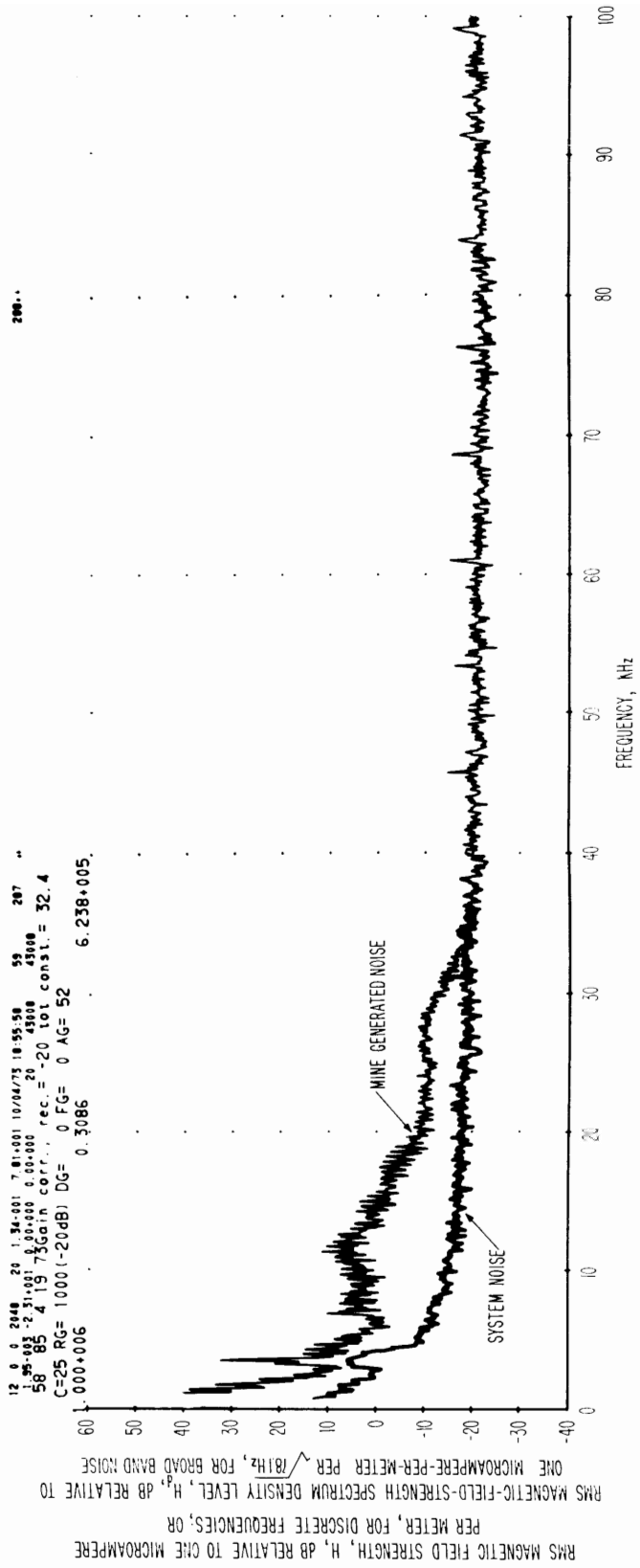

Figure 3-9 Spectrum of magnetic field strength obtained on a
 loop antenna 1 kHz to 100 kHz, Itmann Mine, Farley
 panel, 10 meters from the end of the long-wall face,
 mine in operation, antenna sensitive axis vertical,
 11:50 a.m., April 19, 1973. Spectral resolution
 is 78.1 Hz.

12 1 248 20 2.694111 3.911111 15/13/74 00 26.52 43 20
 1.95-003 3.911111 3.911111 43.000000 43.000000
 54 113 4 17 73Gain corr., rec. = -20.30; const. = 32.4
 C=42 RG= 1000 (-20dB) CG= 0 FG= 0 AG= 52
 1.000+008 0.3086 3.429+007

RMS MAGNETIC FIELD STRENGTH, H, DB RELATIVE TO ONE MICROAMPERE
 PER METER, FOR DISCRETE FREQUENCIES, OR
 RMS MAGNETIC-FIELD-STRENGTH SPECTRUM DENSITY LEVEL, H², DB RELATIVE TO
 ONE MICROAMPERE-PER-METER PER $\sqrt{391}$ Hz, FOR BROAD BAND NOISE

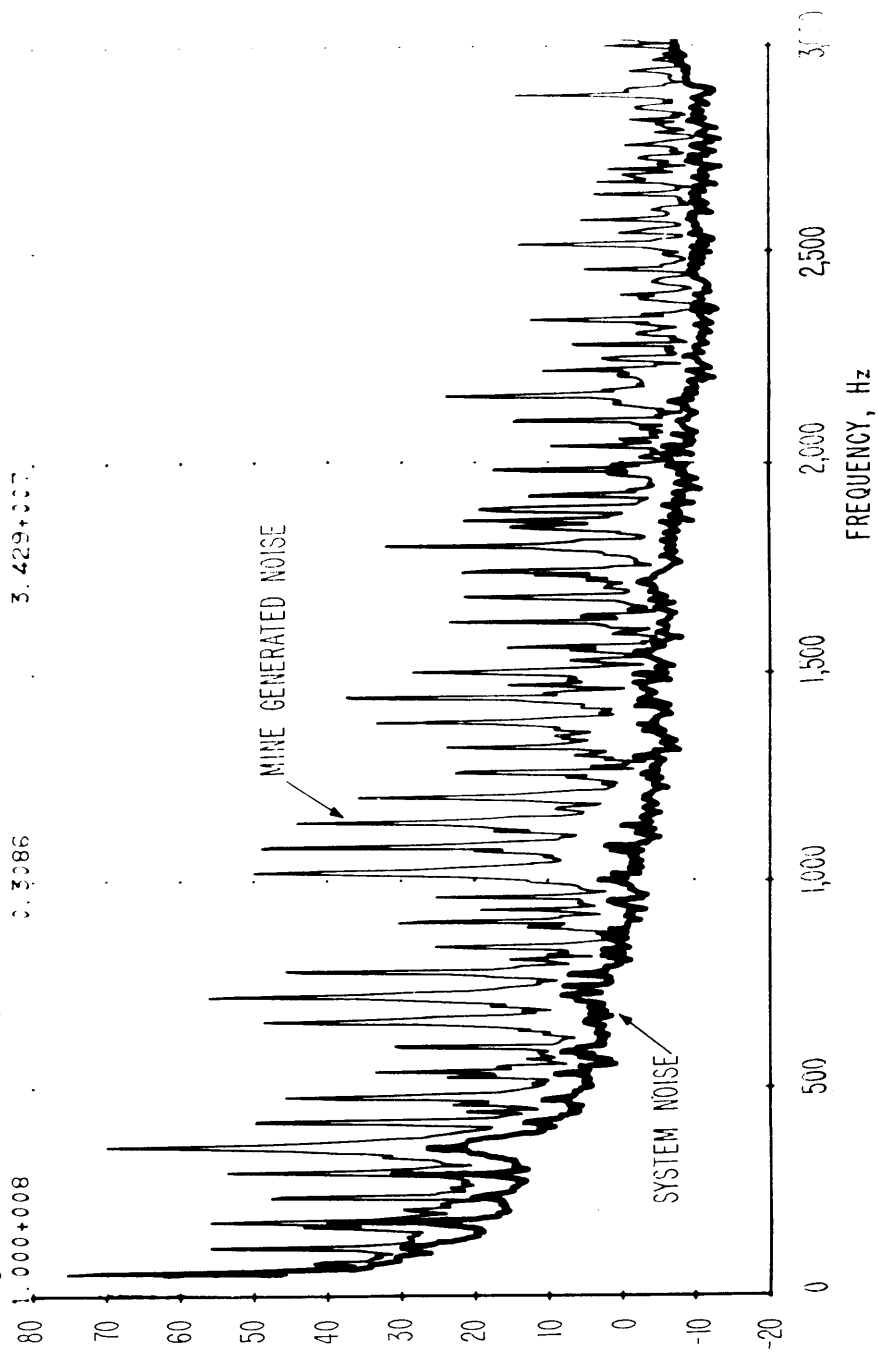

Figure 3-10 Spectrum of magnetic field strength obtained on a loop antenna 40 Hz to 3 kHz, Itmann Mine, Farley panel, 10 meters from the end of the long-wall face, mine in operation, antenna sensitive axis vertical, 11:50 a.m., April 19, 1973. Spectral resolution is 3.91 Hz.

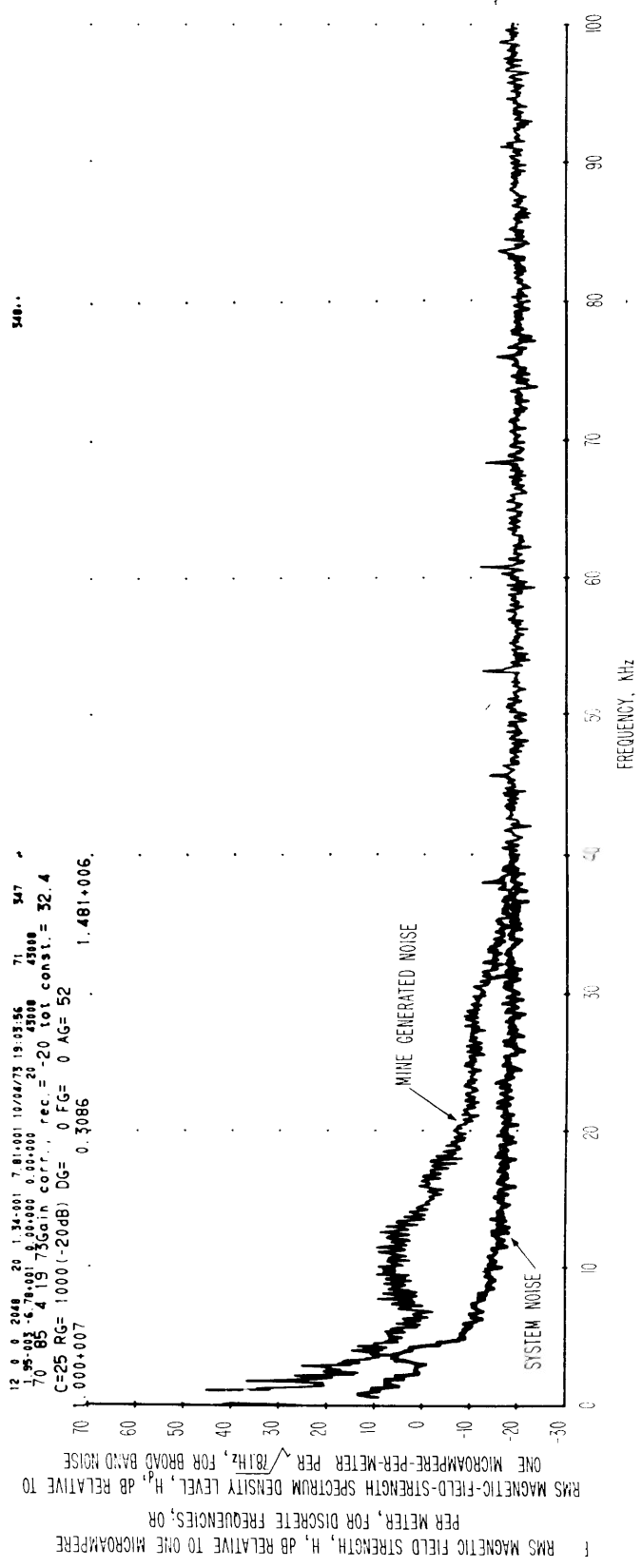

Figure 3-11 Spectrum of magnetic field strength obtained on a loop antenna 1 kHz to 100 kHz, Itmann Mine, Farley panel, 10 meters from the end of the long-wall face, only the hydraulic pump in operation, during lunch hour, antenna sensitive axis horizontal, 1:03 p.m., April 19, 1973. Spectral resolution is 78.1 Hz.

12 0 0 2048 20 2.69+000 3.91+000 15/13/74 22:32:14 50 242
 1.95+003 -4.25+001 0.00+000 0.00+000 21 43:08 43:08
 61 113 4 17 75Gain corr. rec. = -20 tot const. = 32.4
 C=42 RG= 1000 (-20dB) DG= 0 FG= 0 AG= 52
 1.000+008 0.3086 2.247+007.

RMS MAGNETIC FIELD STRENGTH, H, DB RELATIVE TO ONE MICROAMPERE
 PER METER, FOR DISCRETE FREQUENCIES; OR
 RMS MAGNETIC-FIELD-STRENGTH SPECTRUM DENSITY LEVEL, H_p, DB RELATIVE TO
 ONE MICROAMPERE-PER-METER PER $\sqrt{3.91}$ Hz, FOR BROAD BAND NOISE

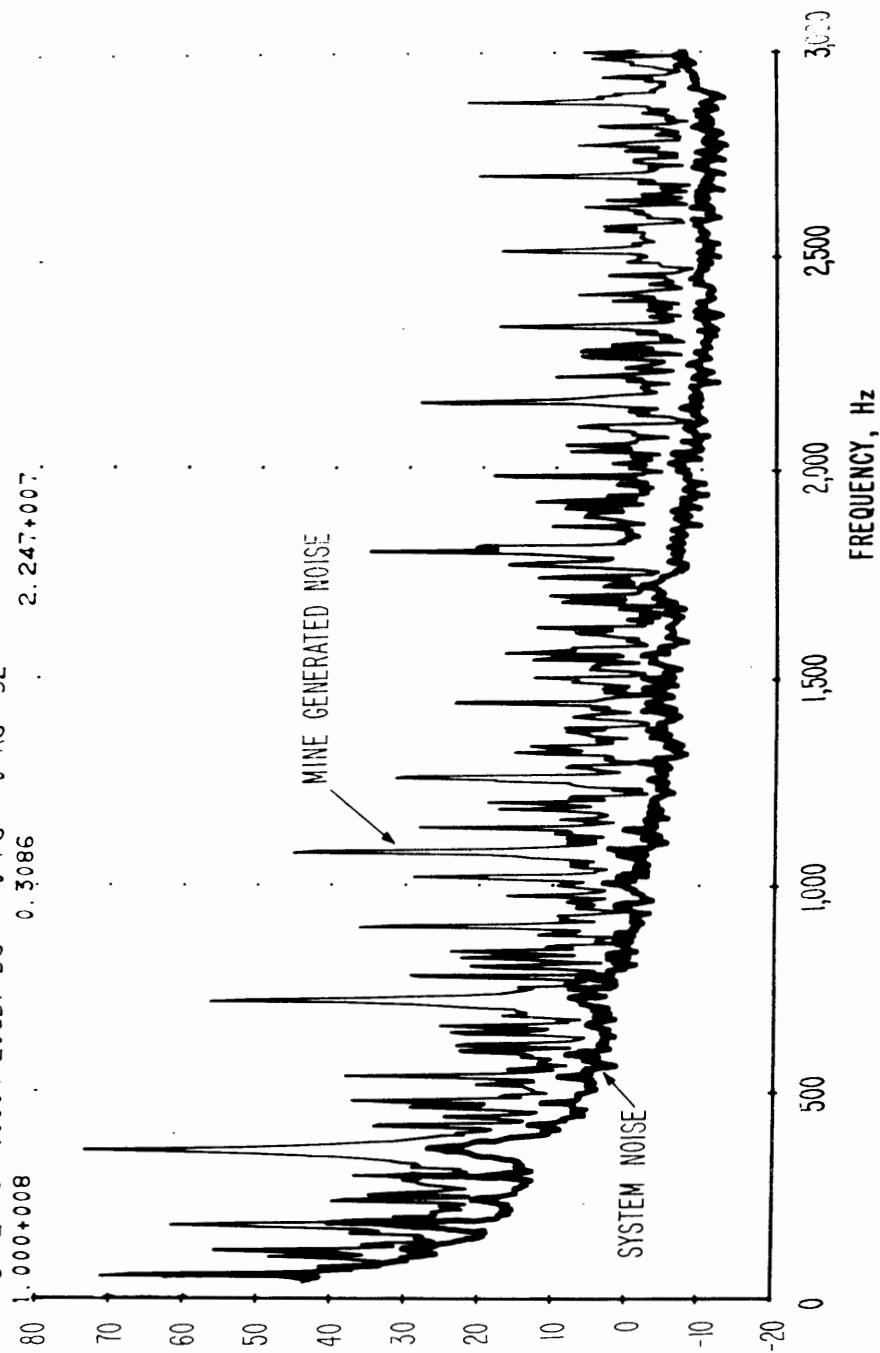

Figure 3-12 Spectrum of magnetic field strength obtained on a loop antenna 40 Hz to 3 kHz, Itmann Mine, Farley panel, 10 meters from the end of the long-wall face, only the hydraulic pump in operation, during lunch hour, antenna sensitive axis horizontal, 1:03 p.m., April 19, 1973. Spectral resolution is 3.91 Hz.

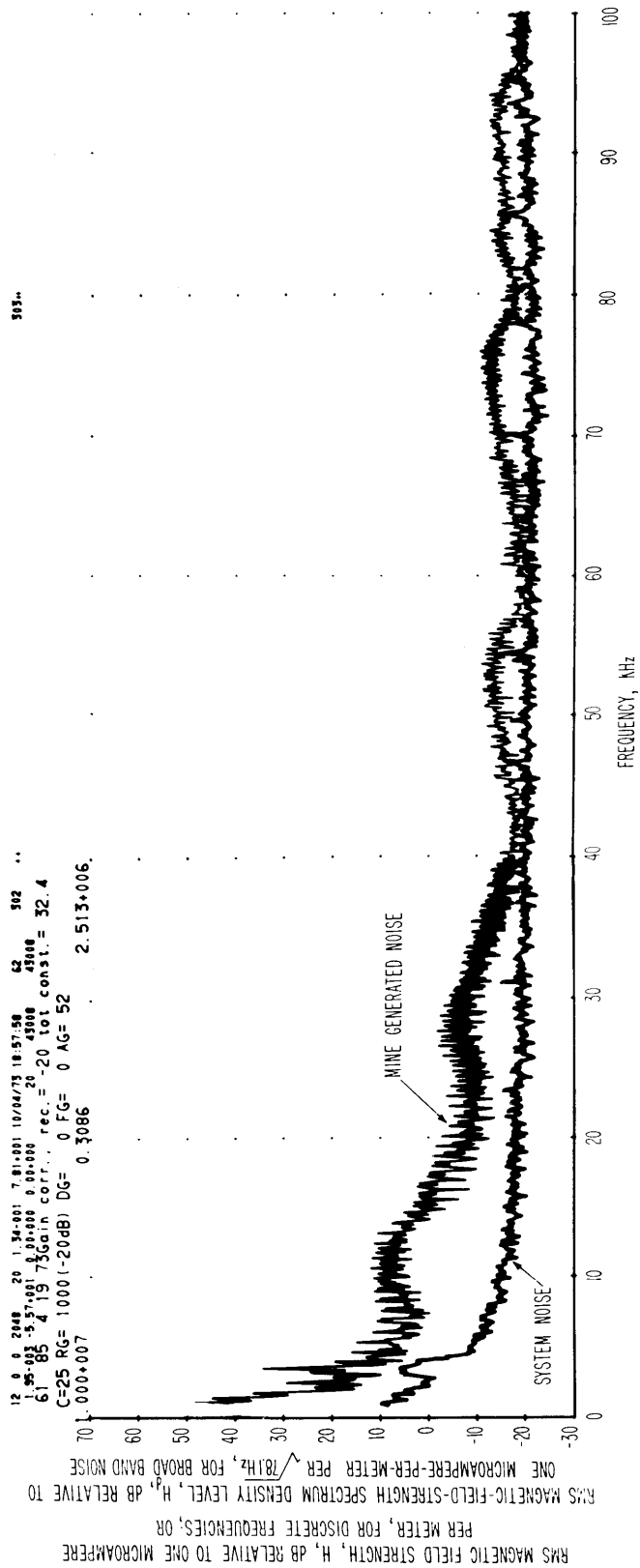

Figure 3-13 Spectrum of magnetic field strength obtained on a loop antenna 1 kHz to 100 kHz, Itmann Mine, Farley panel, 10 meters from the end of the long-wall face, conveyor belt starting up, antenna sensitive axis vertical, 12:42 p.m., April 19, 1973. Spectral resolution is 78.1 Hz.

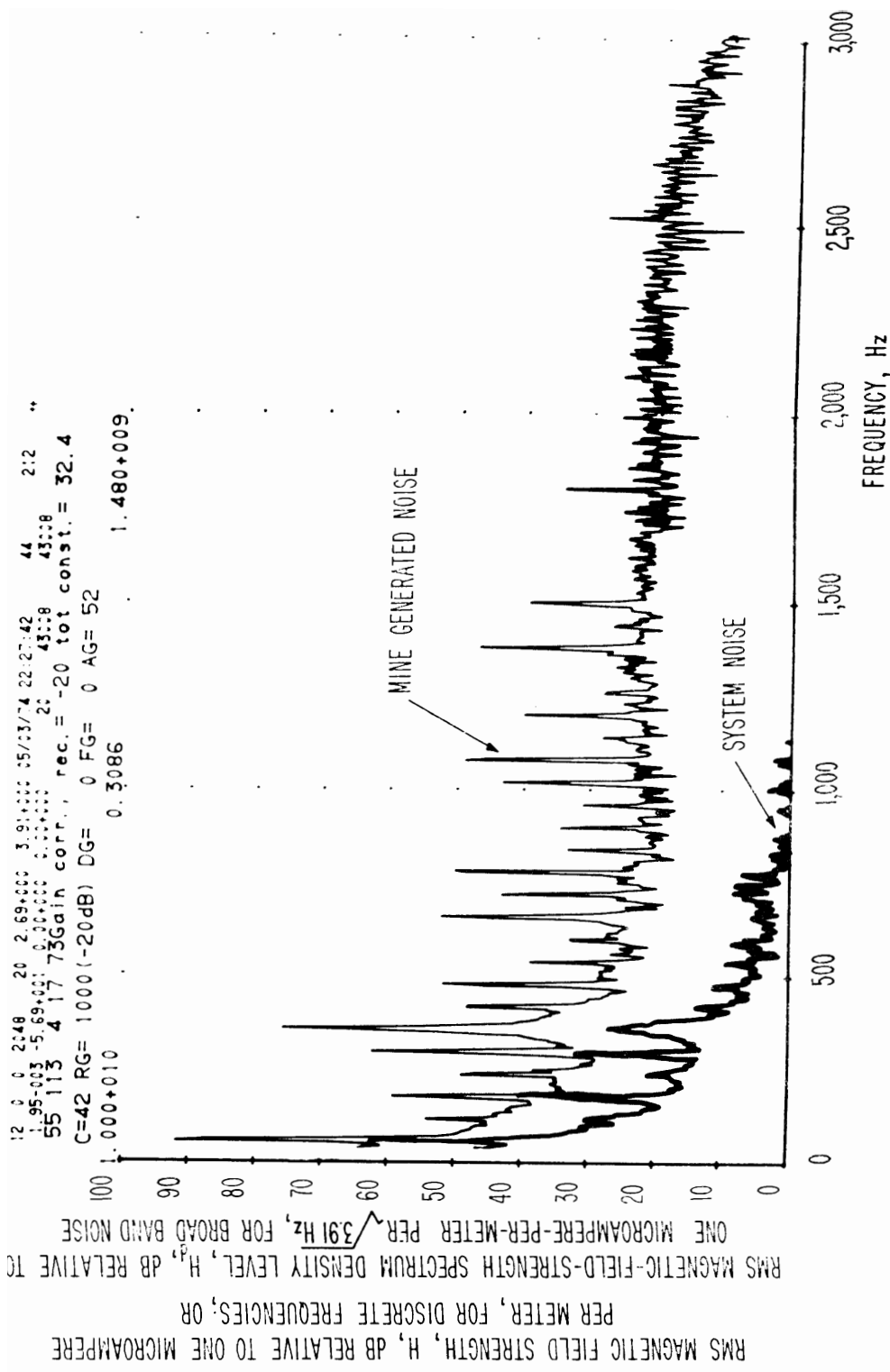

Figure 3-14 Spectrum of magnetic field strength obtained on a loop antenna 4m by 10 3 kilz, Irtant Mine, Farley panel, 10 meters from the end of the long-wall face, conveyor belt starting up, antenna sensitive axis vertical, 12:42 p.m., April 19, 1973. Spectral resolution is 3.91 Hz.

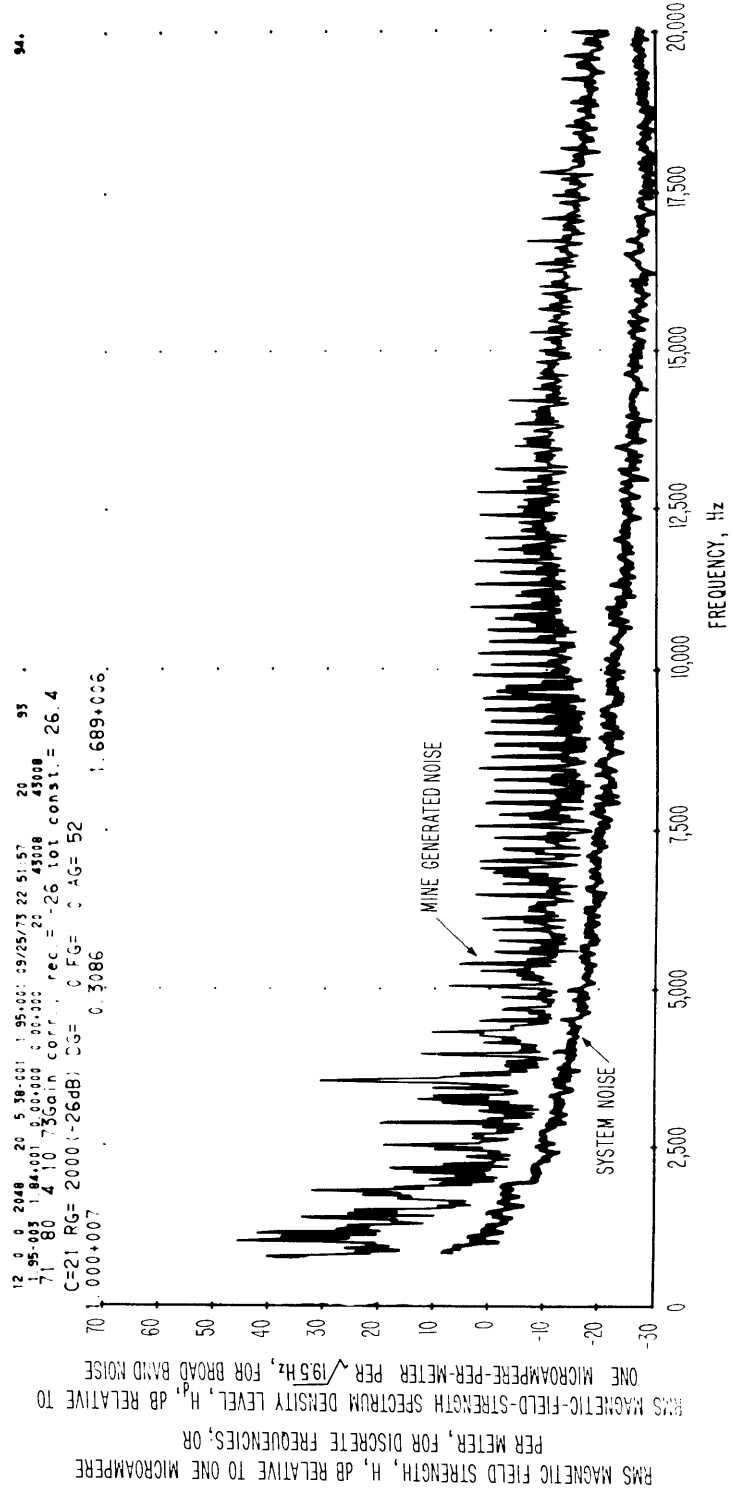

Figure 3-15 Vertical component of magnetic field spectrum about 3 meters from long wall machine, Farley panel, Itmann No. 3 Mine, 2:30 p.m., April 17, 1973. Calibration is valid from 750 Hz to 20 kHz.

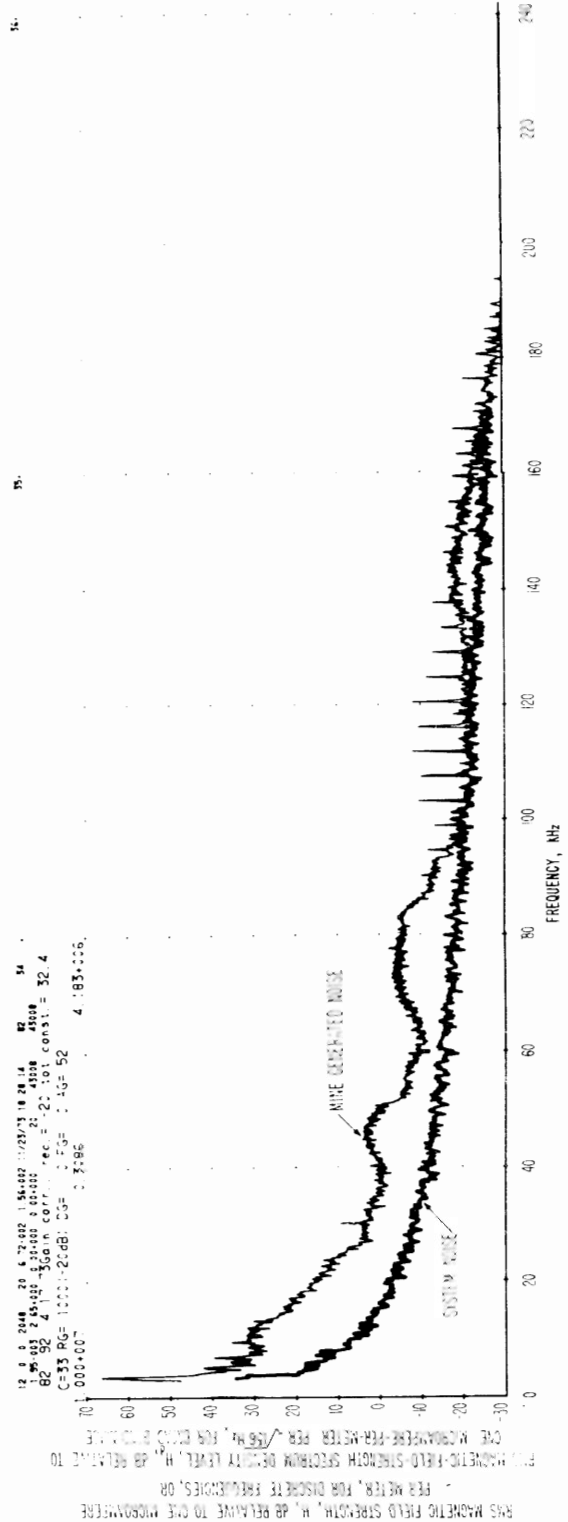

Figure 3-16 Vertical component of magnetic field spectrum at end of haulageway in Farley panel, Itmann No. 3 Mine, 5:05 p.m., April 17, 1973. Calibration is valid from 3 to 180 kHz.

12 8 5 2444 20 4 72 502 1 34 000 002973 19 28 14 52 008 54
 82 92 2 31 34 1 16011 0011 rec = 20 101 const = 32.4
 CS33 PG= 1000-20db: CGF 1 52 1 40= 52
 000-007 1 3386 4 183-000

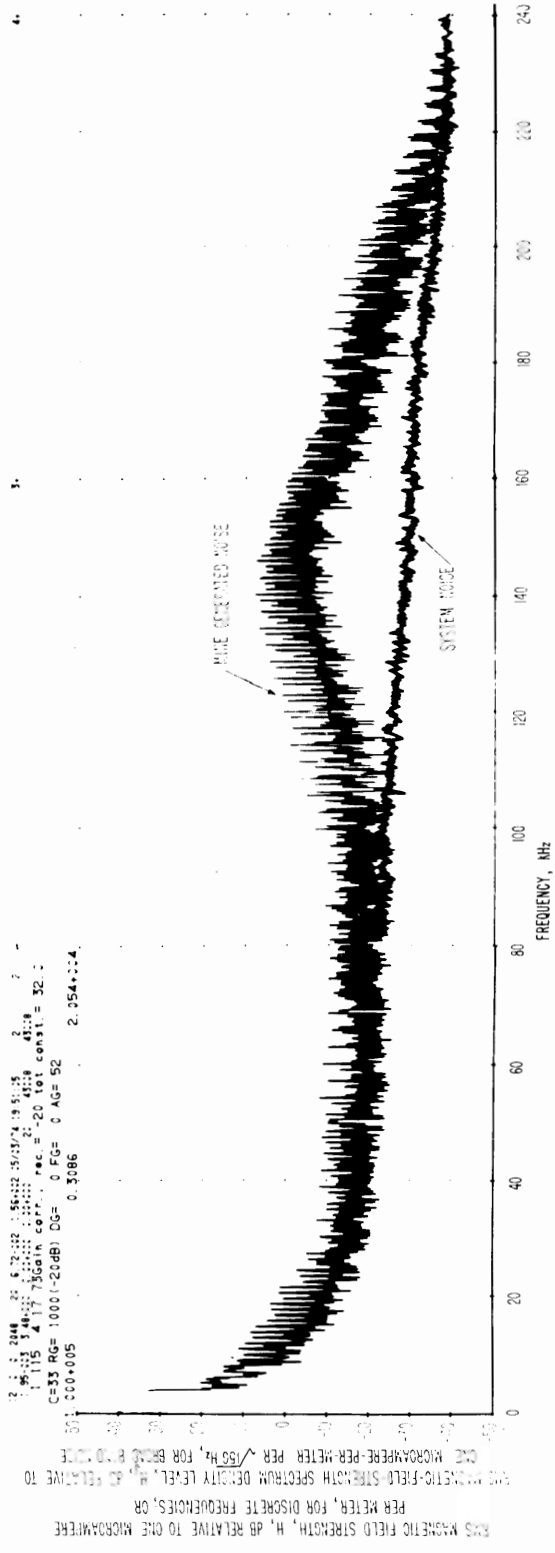

Figure 3-17 Vertical component of magnetic field spectrum at end of haulage way in Farley panel, Itmann No. 3 Mine, 12:20 p.m., April 17, 1973. Calibration is valid from 3 to 180 kHz.

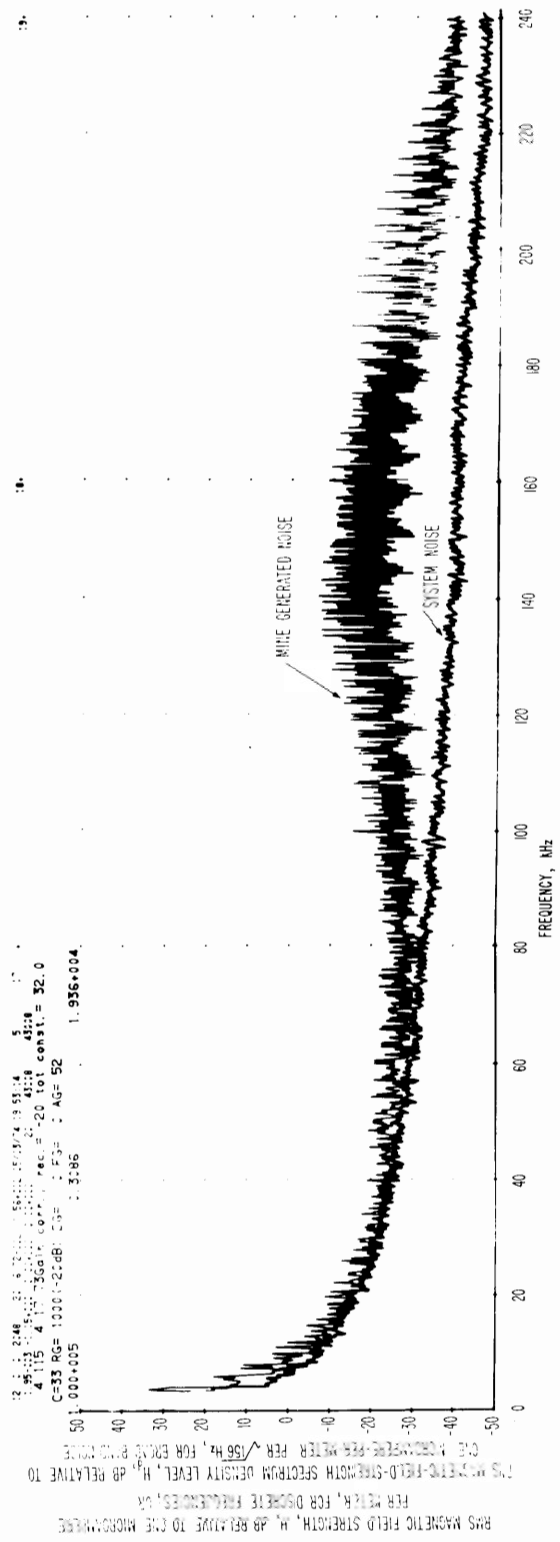

Figure 3-18 Horizontal component of magnetic field spectrum at end of haulageway in Farley panel, Itmann No. 3 Mine, 12:20 p.m., April 17, 1973. Calibration is valid from 3 to 180 kHz.

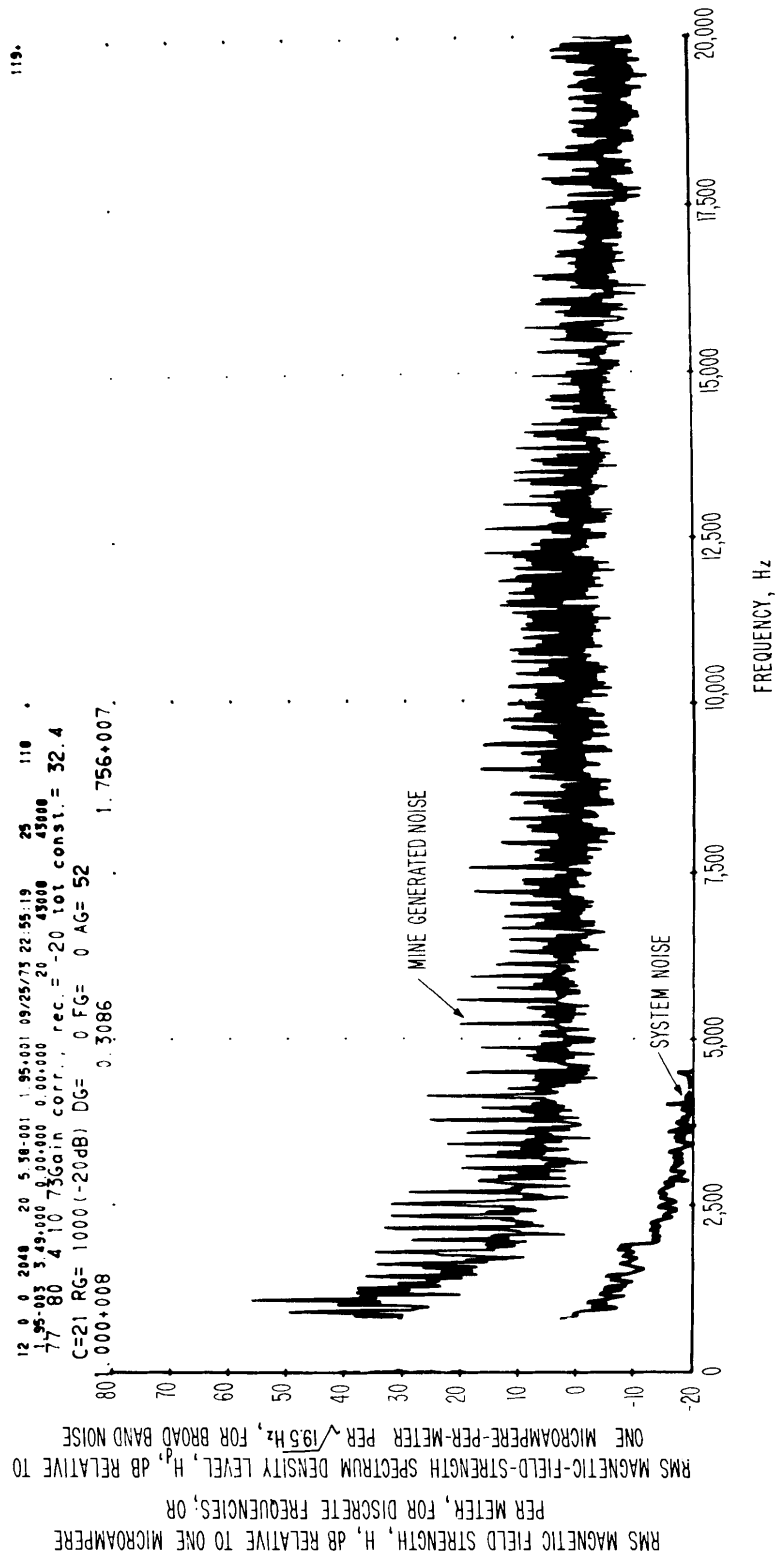

Figure 3-19 Vertical component of magnetic field spectrum at end of haulageway in Farley panel, Itmann No. 3 Mine, 12:25 p.m., April 17, 1973. Calibration is valid from 750 Hz to 20 kHz.

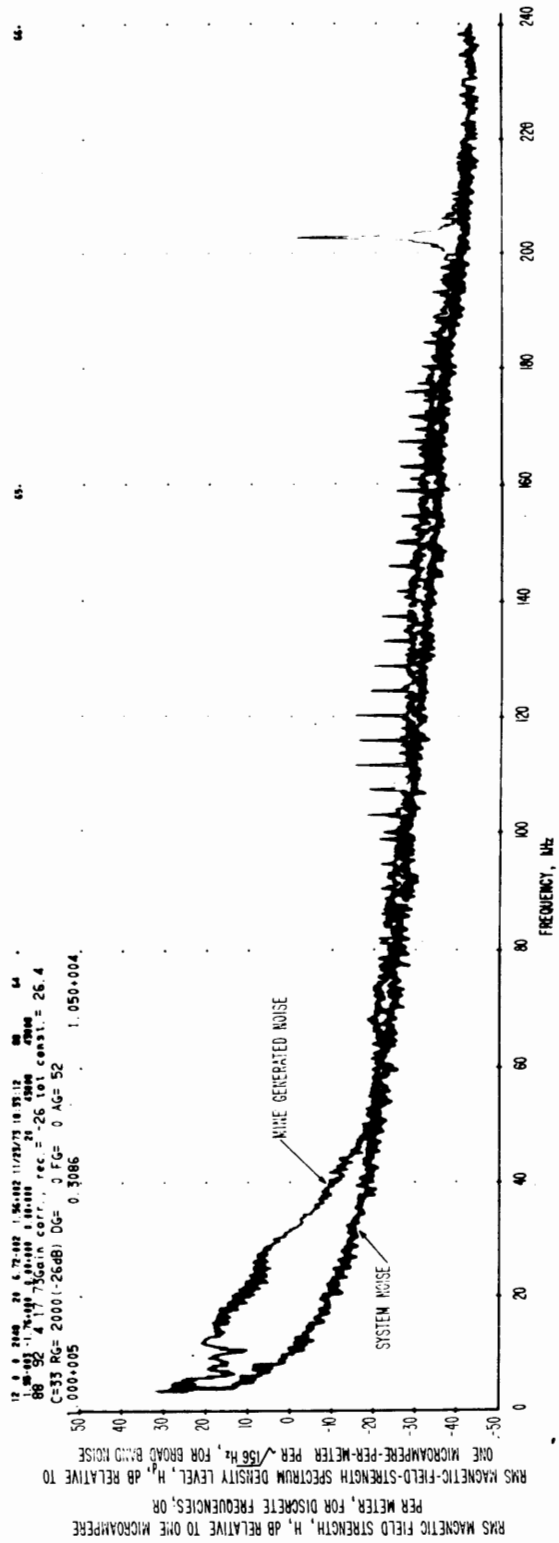

Figure 3-20 Vertical component of magnetic field spectrum at end of haulageway in Farley panel, Itmann No. 3 Mine, 6:15 p.m., April 17, 1973. Calibration is valid from 3 to 180 kHz.

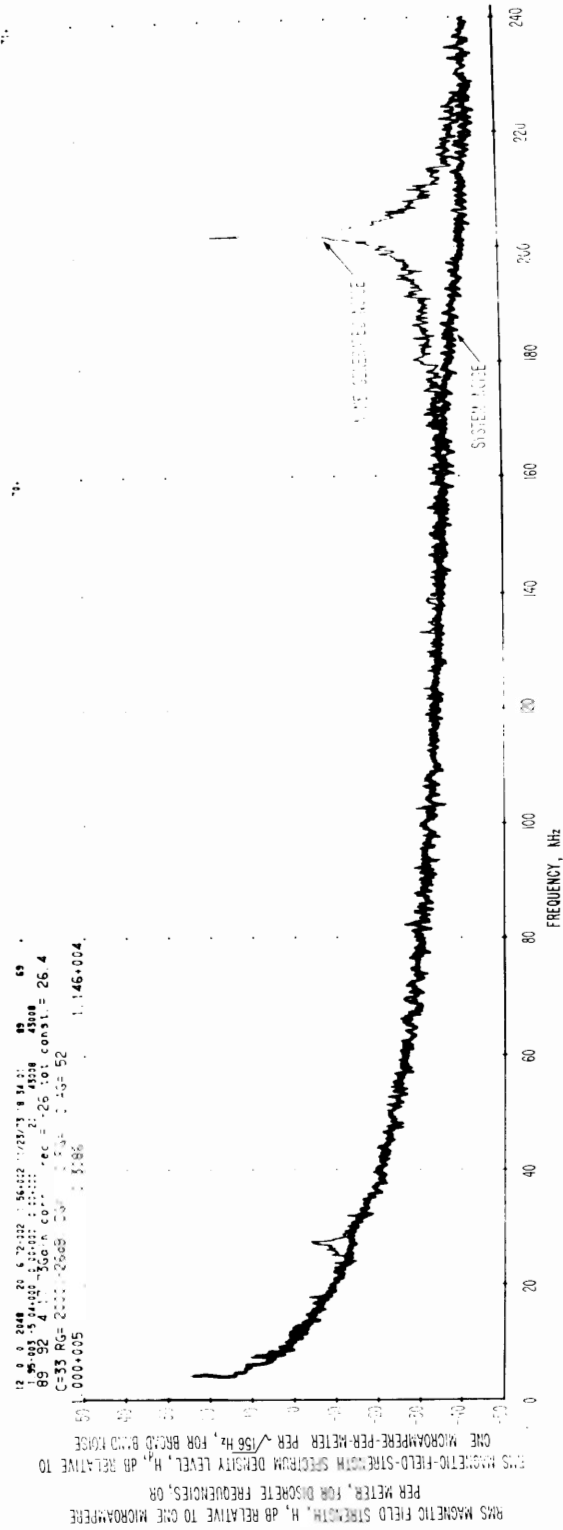

Figure 3-21 Horizontal component of magnetic field spectrum at end of haulageway in Farley panel, Itmann No. 3 Mine, 6:15 p.m., April 17, 1973. Calibration is valid from 3 to 180 kHz.

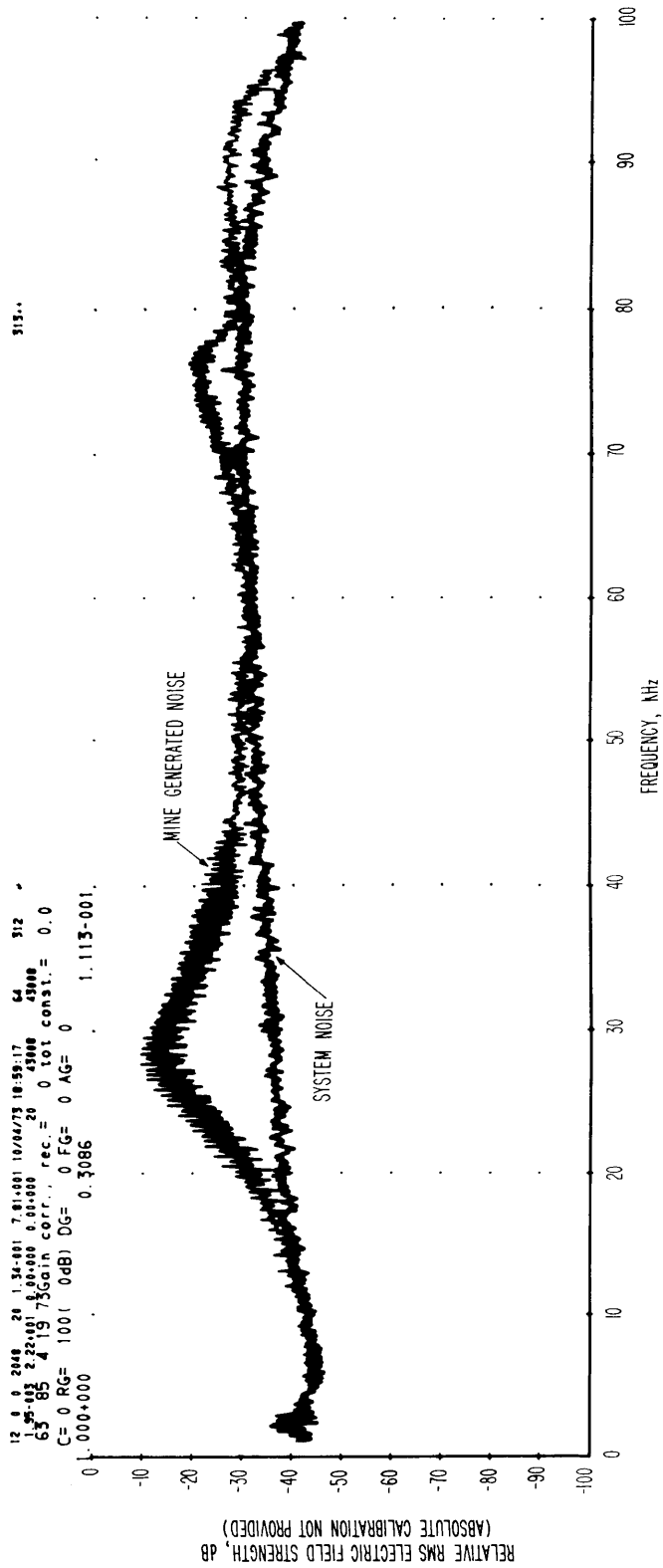

Figure 3-22 Spectrum of electric field strength obtained with an active dipole 1 kHz to 100 kHz, Itmann Mine, underground, Farley panel, dipole ends parallel with drift, 0.75 meters from phone line, conveyor belt starting up, 12:42 p.m., April 19, 1973. Spectral resolution is 78.1 Hz.

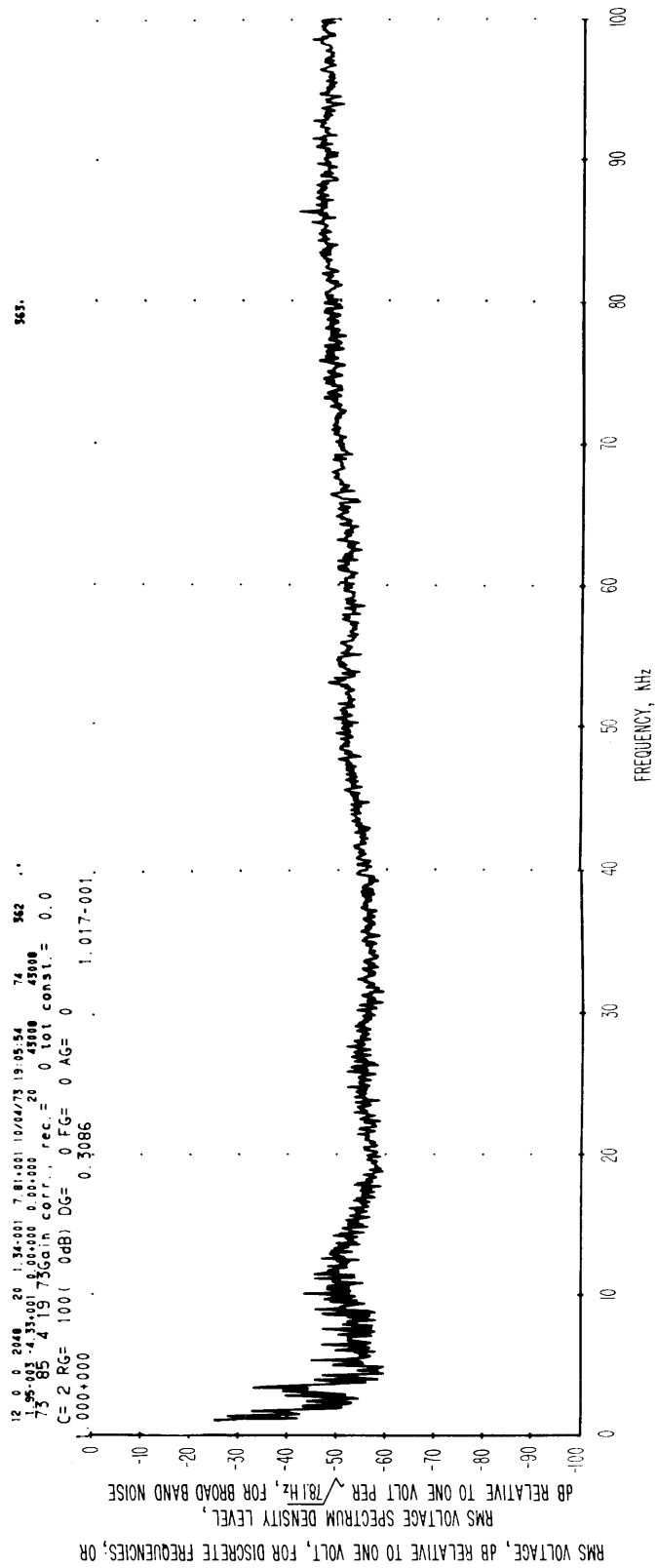

Figure 3-23 Voltage spectrum obtained from roof bolts located
 15.2 meters apart, 1 kHz to 100 kHz, Itmann Mine,
 Farley panel, 1:45 p.m., April 19, 1973. Spectral
 resolution is 78.1 Hz.

12 0 0 2048 20 2.69+000 3.91+000 06/13/74 22:08:30 52 *
 1.95-003 8.96+001 0.00+000 0.00+000 20 43008 43008
 63 113 4 17 73Gain corr., rec.= 0 tot const.= 0.0
 C=44 RG= 100(0dB) DG= 0 FG= 0 AG= 0
 0.3086 1.849-002.

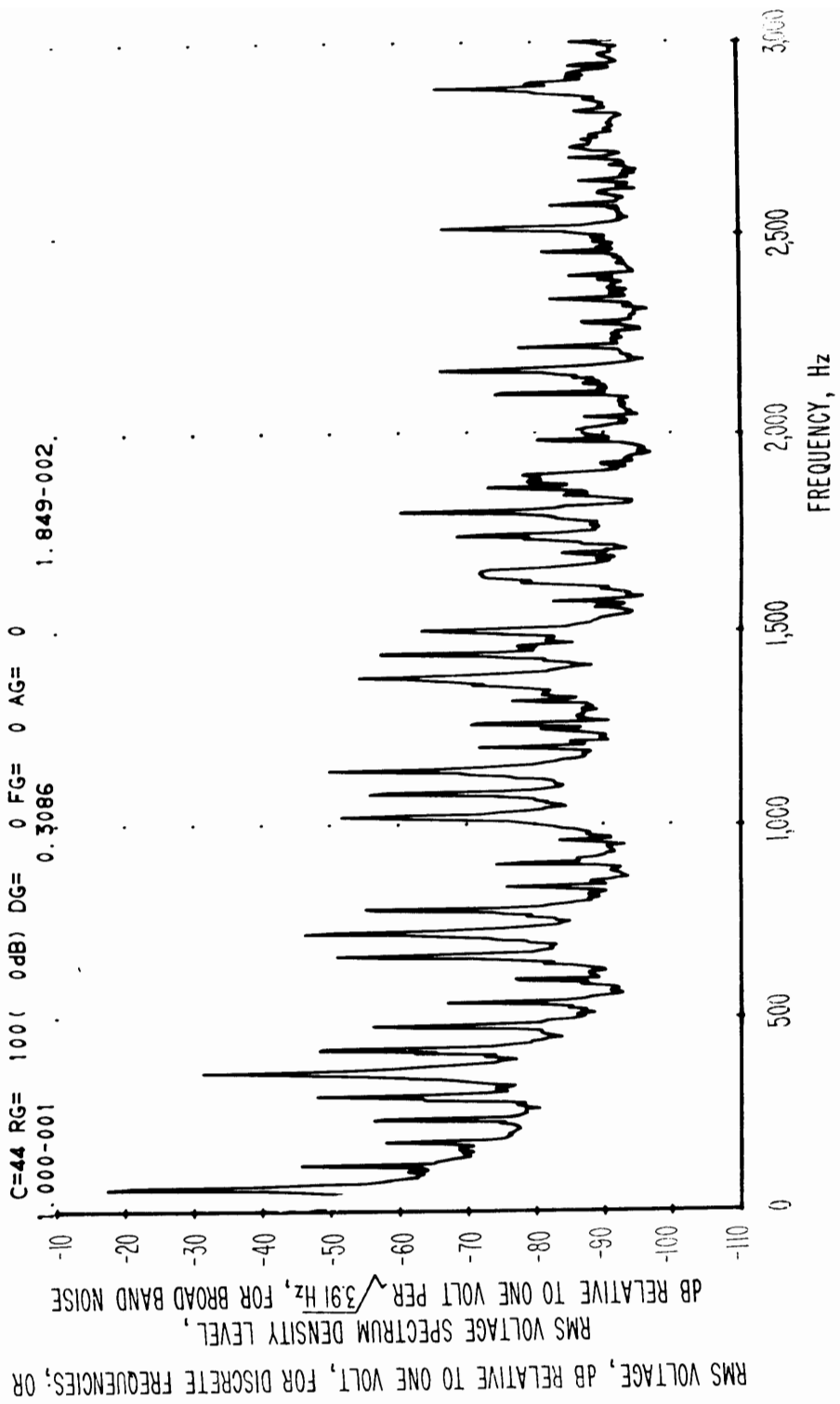

Figure 3-24 Voltage spectrum obtained from roof bolts located 15.2 meters apart, 40 Hz to 3 kHz, Itmann Mine, Farley panel, 1:45 p.m., April 19, 1973. Spectral resolution is 3.91 Hz.

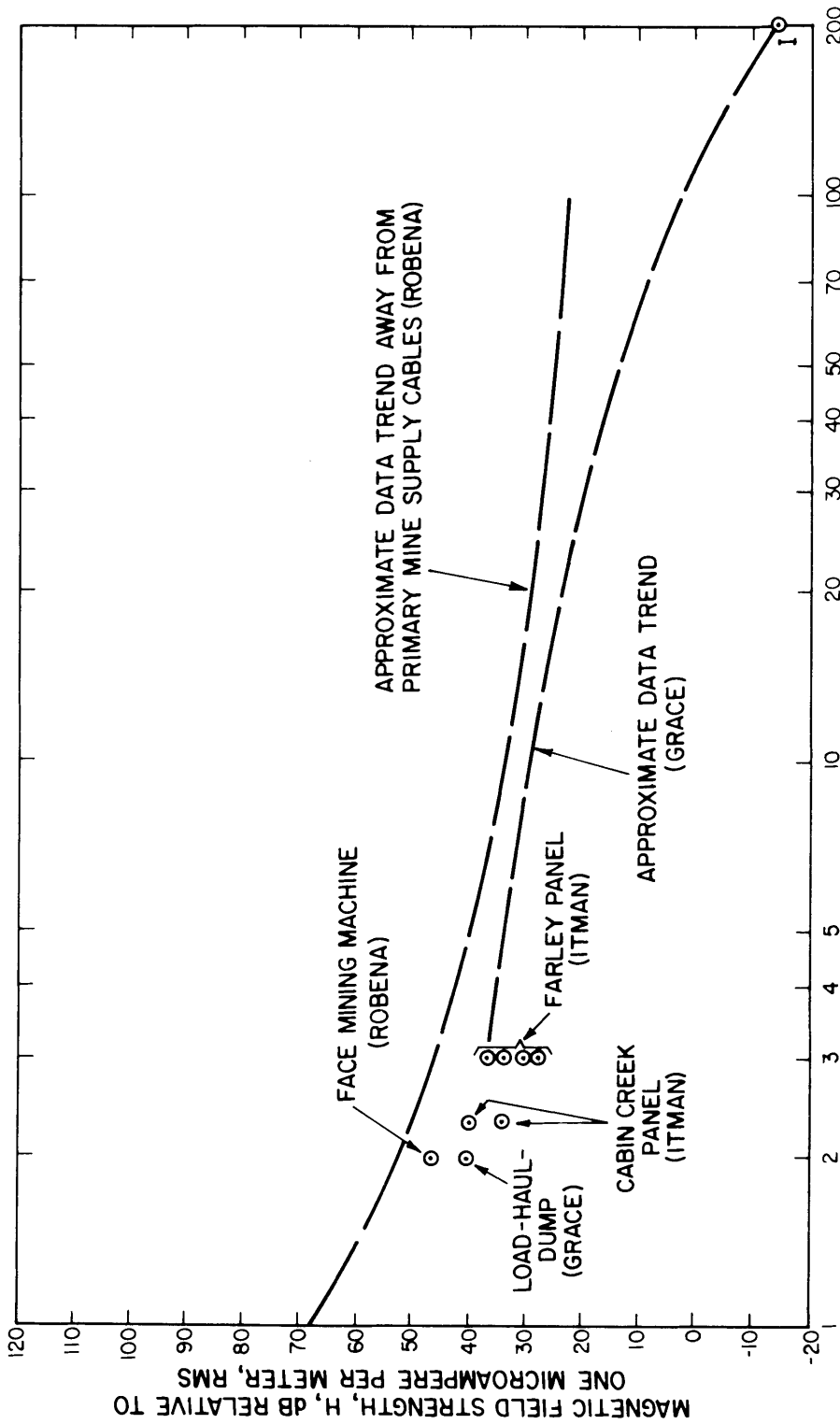

Figure 3-26 Comparison of the logarithmic average of magnetic field strengths at six frequencies between 1 kHz and 3 kHz of Itmann, Grace, and Robena Mines as a function of distance from noise source.

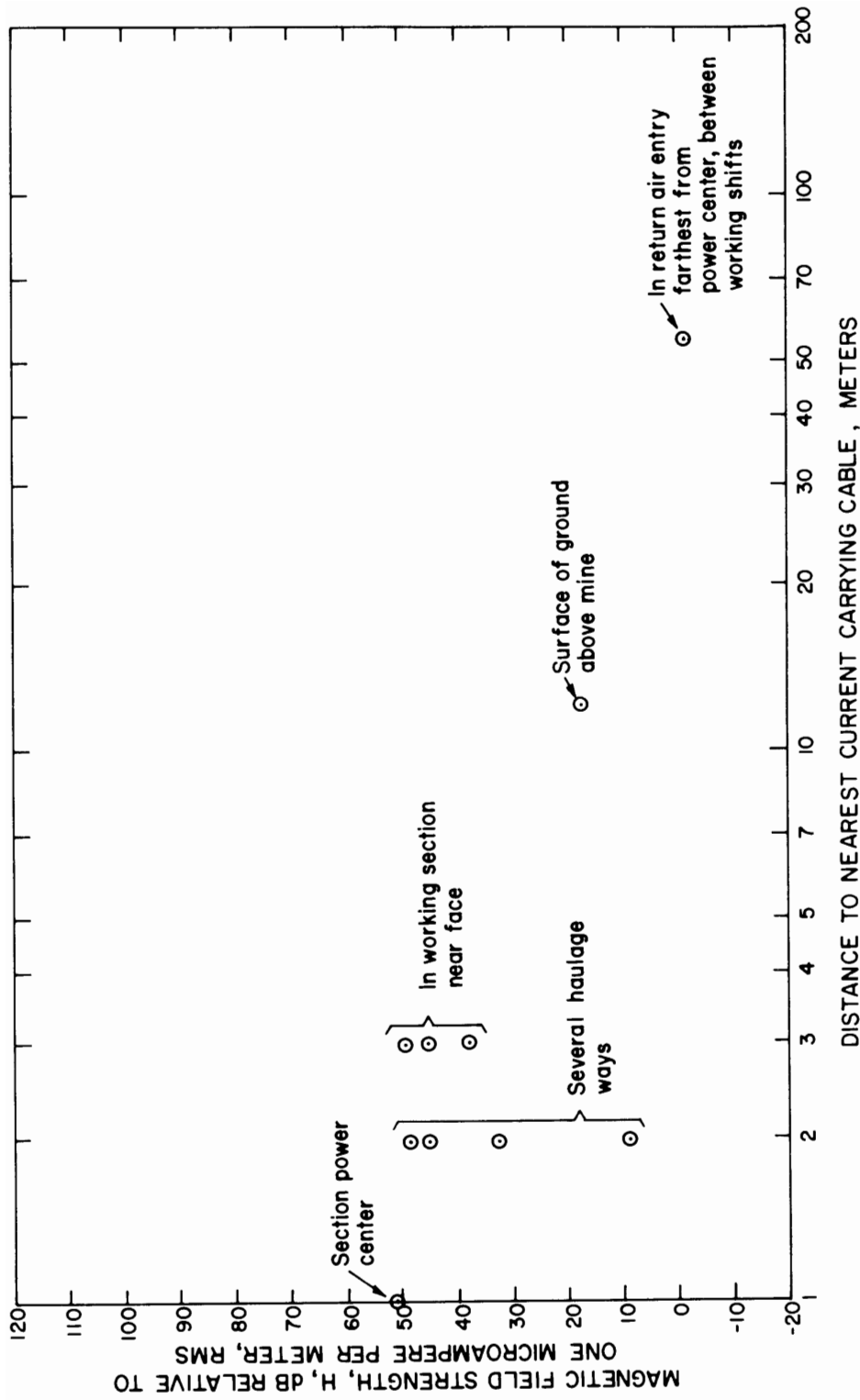

Figure 3-27 Logarithmic average magnetic field strength in McElroy Coal Mine in the frequency range 1080 Hz to 2880 Hz, produced usually by power line harmonics 3 through 8 of 360 Hz. Antenna sensitive axis orientation is vertical (up-down).

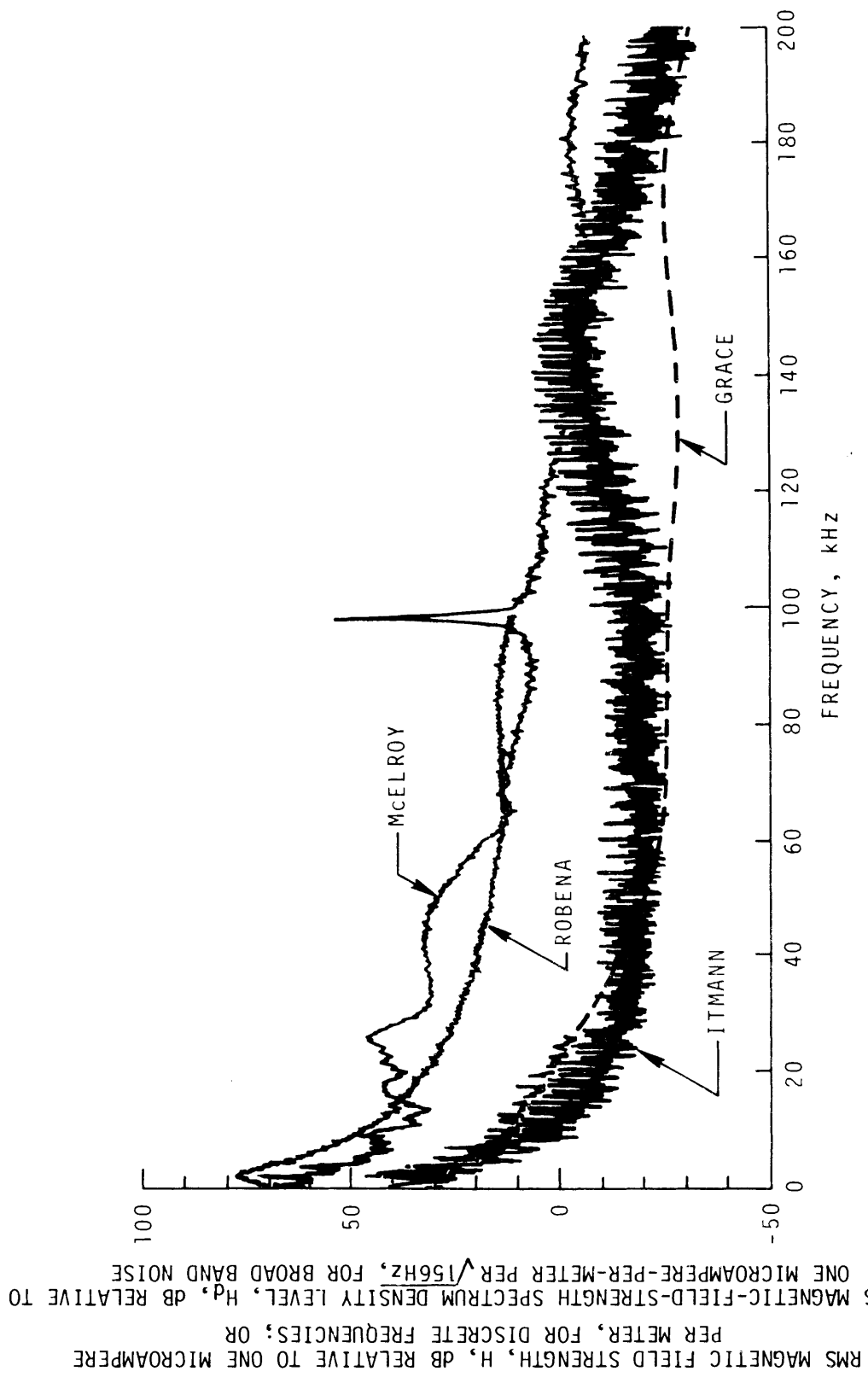

Figure 3-28 Comparison of E-M noise levels near operating machinery from four mines. Vertical magnetic-field components are shown. Broken sections of the curves represent system noise.

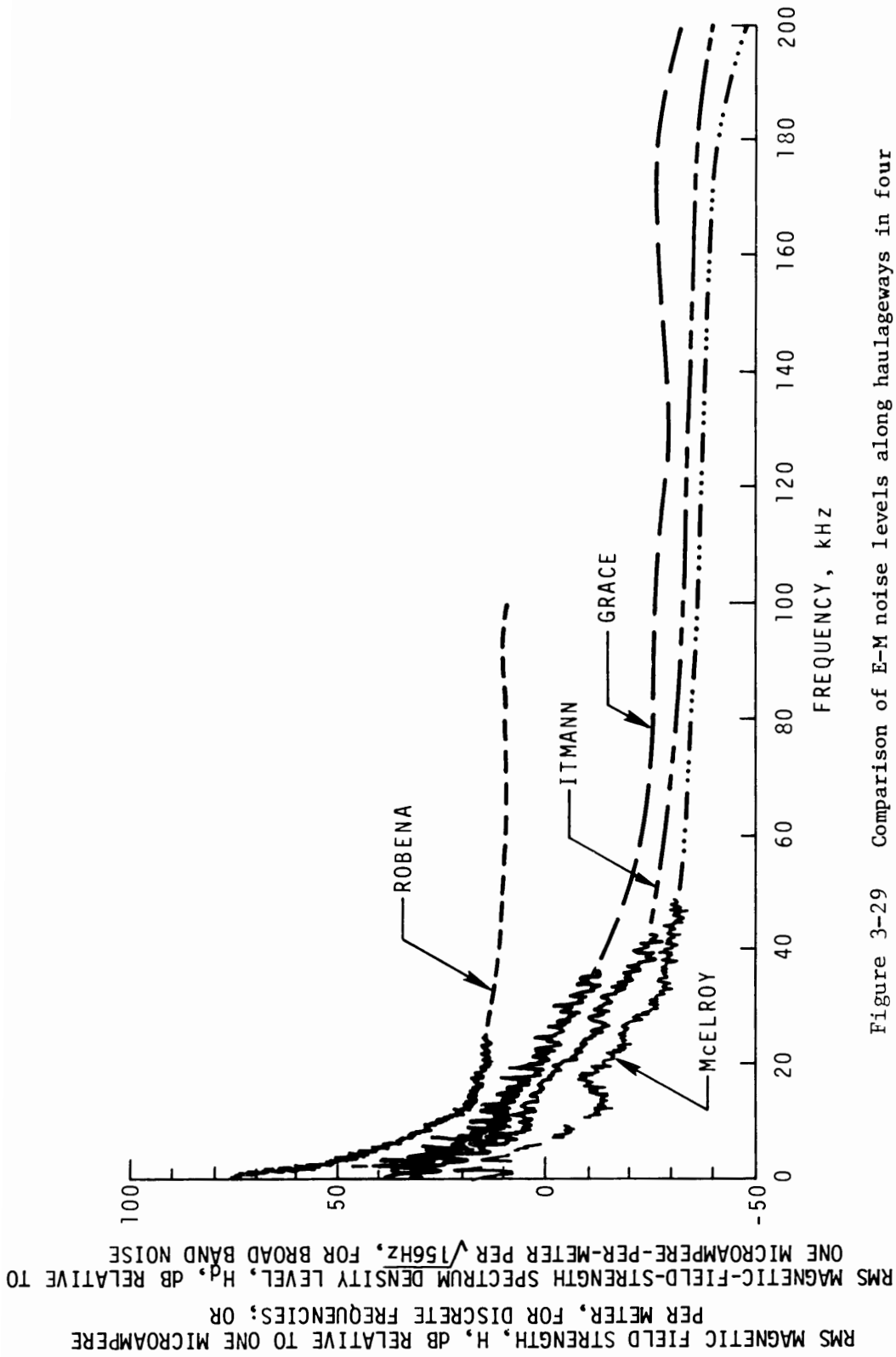

Figure 3-29 Comparison of E-M noise levels along haulageways in four mines. Vertical magnetic-field components are shown. Broken sections of the curves represent measurement-system noise levels.

4. AMPLITUDE PROBABILITY DISTRIBUTION MEASUREMENTS

4.1 Introduction and Uncertainties

Statistical representations are required since the variations of field strength are, in general, random. The amplitude probability distribution (APD) of the received noise envelope is one of the most useful statistical descriptions of the noise process for the design and evaluation of a telecommunications system operating in a noisy environment [5,6,8].

By plotting the cumulative APD on Rayleigh graph paper, one can show clearly the fraction of time that noise envelope exceeds various levels. Rayleigh graph paper is chosen with scales such that a Rayleigh distribution (i.e., envelope distribution of Gaussian noise) plots as a straight line with slope of $-1/2$. Noise with rapid large changes in amplitude (e.g., impulsive noise) then has a much steeper slope, typically -4 or -5 , depending on the impulsiveness of the noise and the receiver bandwidth.

With the exception of the roof-support bolt measurements, all APD measurements are reported in absolute quantities.

The estimated limits of error for the APD noise measurements are ± 5 dB. Several sources of error that are critical to the overall accuracy of our measurements are listed below:

1. Use of a discrete, digital level counter (levels are 6 dB apart) contributes ± 1 -dB quantization error limit. One-decibel step attenuators are used to achieve the \pm one decibel.
2. The system, i.e., recording, data transcribing, and data processing, has a calibration uncertainty of ± 0.5 dB [4].
3. The estimated uncertainty involved in using the portable and the laboratory tape recorders for record and playback is ± 0.5 dB due to harmonic distortion, flutter, dropout, cross-talk, etc.

4. The gain instability during measurements, gain changes between measurements and calibration, and the non-linearity of electromagnetic interference and field strength (EIFS) meters and mixers, all combined, contribute ± 0.5 dB uncertainty.

5. The gain instability and non-linearity of the digital level counter, the tuned frequency converter, the amplifier, and attenuators, all combined, contribute ± 0.5 dB uncertainty.

6. Connector losses and BNC cable losses, particularly at higher frequencies above 100 kHz, contribute ± 2.0 dB uncertainty.

Some additional uncertainty beyond the stated measurement system uncertainty is caused by the in-mine environment. Care was taken to provide at least one meter separation from metallic objects wherever possible. However, coal, rock, or earth was sometimes immediately adjacent to a loop antenna. In all observed cases, this had no effect at frequencies up to 1 MHz. Above 1 MHz, earth and other reflections did in some cases cause ± 1 dB variations, even with a shielded, balanced loop antenna. An estimate is that an additional ± 5 dB uncertainty might be advisable. However, due to the complexity of the shielded loop in the mine environment, this uncertainty cannot be rigorously bounded without substantial additional analysis.

4.2 Results

4.2.1 Introduction

APD measurements were made on April 17 and 19, 1973, during operation in the Itmann #3 Coal Mine located near Mullens, southwest of Beckley, West Virginia. Descriptions of this mine are given in section 1.2. APD measurements were

made at three locations. The first set of APD measurements was made on April 17, 1973, at Cabin Creek panel. Here, APD measurements were made both during the operation of the mine and during a period when the mining equipment was turned off. In addition, APD measurements between roof-support bolts were performed. The second set of APD measurements was made on April 17 at Farley panel, and the third set of measurements was made on April 19 at the headpiece for the main conveyor belt for Farley panel beside the mainline rail haulage. In these sets of APD measurements, only the vertical components of magnetic field were measured. In addition, APD measurements between roof-support bolts were performed at the Farley headpiece on April 19, 1973.

4.2.2 Measurement Results

Figures 4-1 through 4-12 show the APD's of the vertical component of the magnetic field noise measured during operation of the mine at Cabin Creek panel, location A, figure 3-1, on April 17, 1973. APD's measured during a period when mining equipment was not operating are shown in figures 4-13 through 4-19. In these "quiet" measurements (with levels that are sometimes higher than during normal operation), the vertical components of magnetic noise were measured at frequencies ranging from 10 kHz to 6 MHz. Above 100 kHz, the magnetic field strength levels are not substantially different during quiet time compared to normal operation. The harmonics of 88 kHz trolley phones extend to 8 MHz, and there are other higher frequency carriers, e.g., 202.5 kHz.

Figure 4-20 shows the roof-support bolt measurement made at Cabin Creek panel, location A in figure 3-1, on April 17, 1973. The separation between the two roof-support bolts was 1.5 meters, and the APD's were measured using non-shielded copper wire connected between the roof-support bolts and

the electromagnetic intensity and field strength (EIFS) meter. The dc resistance measured with a dc ohmmeter connected to these roof-support bolts was $30\text{k}\Omega$. The RF impedance measured at 10 kHz using a CW generator, RF voltmeter, and RF current meter was $8\text{ k}\Omega$. It is not easy to analyze what was measured through non-shielded copper wires. It is a combination of electric field coupled through a dipole with a lossy surrounding medium (i.e., coal) and of magnetic field through a lossy loop antenna, and of voltage induced by current flowing through the medium between the roof bolts. Therefore, relative voltage is the parameter given. The rms value is arbitrarily assigned the value 0 dB.

Figures 4-21 through 4-28 show APD measurements of the vertical component of magnetic field noise measured about 70 meters (230 ft.) from the longwall face in Farley panel on April 17, 1973. Figures 4-29 through 4-40 show APD's of the vertical component of magnetic field noise measured at the headpiece for Farley main conveyor belt on April 19, 1973. Generally, the levels at the headpiece are about 20 dB higher than the levels 70 meters from the face. The length of time for each APD measurement is nominally 20 minutes; for the relatively long work cycle in a longwall mine, 20 minutes is insufficient time to provide statistical validity. Also, along main haulageways, the time required may be much longer than 20 minutes.

Figure 4-41 shows the roof-support bolt measurements made at the Farley headpiece on April 19, 1973. The separation between the two roof-support bolts was one meter, the dc resistance between these roof bolts was $30\text{ k}\Omega$, whereas the RF impedance at 10 kHz was $5.5\text{ k}\Omega$. Again, the units are relative voltage, with the rms value arbitrarily assigned the value 0 dB.

4.2.3 RMS and Average Values

The APD's are integrated to give rms and average values of the field strength, according to the equations

$$H_{\text{avg}} = - \int_0^{\infty} H \, dp(H)$$

and

$$H_{\text{rms}} = \left(- \int_0^{\infty} H^2 \, dp(H) \right)^{\frac{1}{2}},$$

where H represents the magnetic field strength of the noise, and p is the probability that the measured field strength exceeds the value H. These quantities are also dependent on the measurement bandwidth, the length of the data run, and possibly other parameters. Finite series are actually used for the numerical integration. The rms and average values so arrived at are identified on each graph and are time averages (23 minutes) of these time-dependent parameters. If the tapes are played into ordinary rms-reading meters, the meter readings will vary 10 to 20 dB over fractions of a second. The rms value is directly relatable to noise power. With these wide variations of field strength with time, the most suitable presentations are statistical.

Excursions of field strength between 0.001 and 99 percent, as well as rms and average values, are summarized in figures 4-42 through 4-45. The predetection bandwidth for these APD measurements either is 1 kHz or is normalized to 1 kHz. Figure 4-42, vertical component, Cabin Creek, is the summary figure for curves shown in figures 4-1 through 4-12. Figure 4-43, vertical component, quiet time, Cabin Creek, is the summary figure for curves shown in figures 4-13 through 4-19. Figure 4-44, vertical component, Farley Panel, is the summary figure for curves shown in figures 4-21 through 4-28. Figure 4-45,

vertical component, Farley Headpiece, is the summary figure for curves shown in figures 4-27 through 4-40.

Magnetic field strength generally decreases monotonically with increasing frequency at 20 dB per decade. A significant exception occurred during "quiet" time. Possibly due to the heavy use of 88 kHz trolley phones (with their attendant harmonics), during this period, the levels from 100 kHz to 6 MHz were frequency independent, and higher than during normal operation at the higher frequencies.

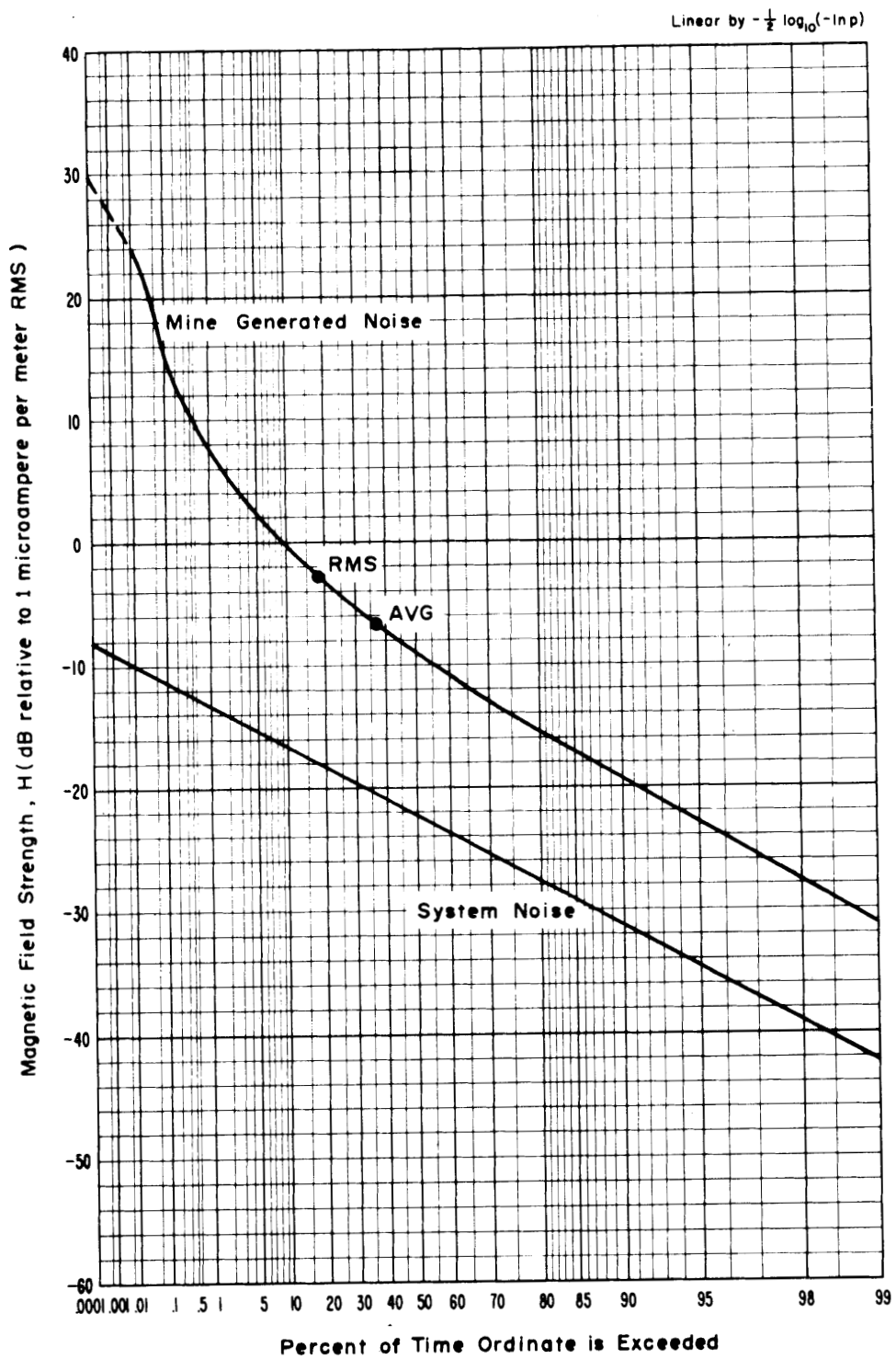

Figure 4-1 APD, 10 kHz, vertical component, 1.0 kHz predetection bandwidth, April 17, 1973, 11:40 a.m., Cabin Creek, Itmann #3.

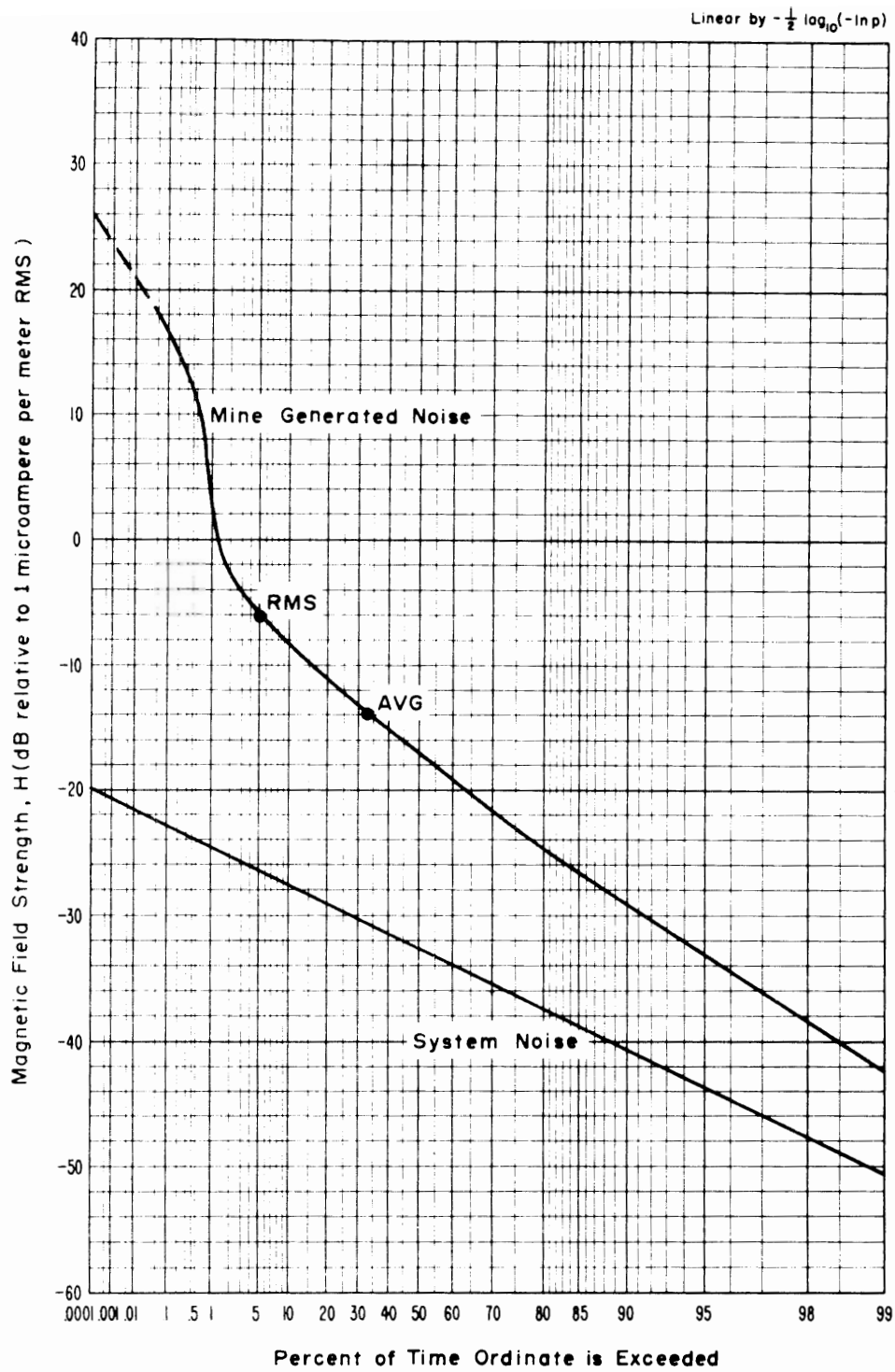

Figure 4-2 APD, 30 kHz, vertical component, 1.0 kHz predetection bandwidth, April 17, 1973, 12:20 p.m., Cabin Creek, Itmann #3.

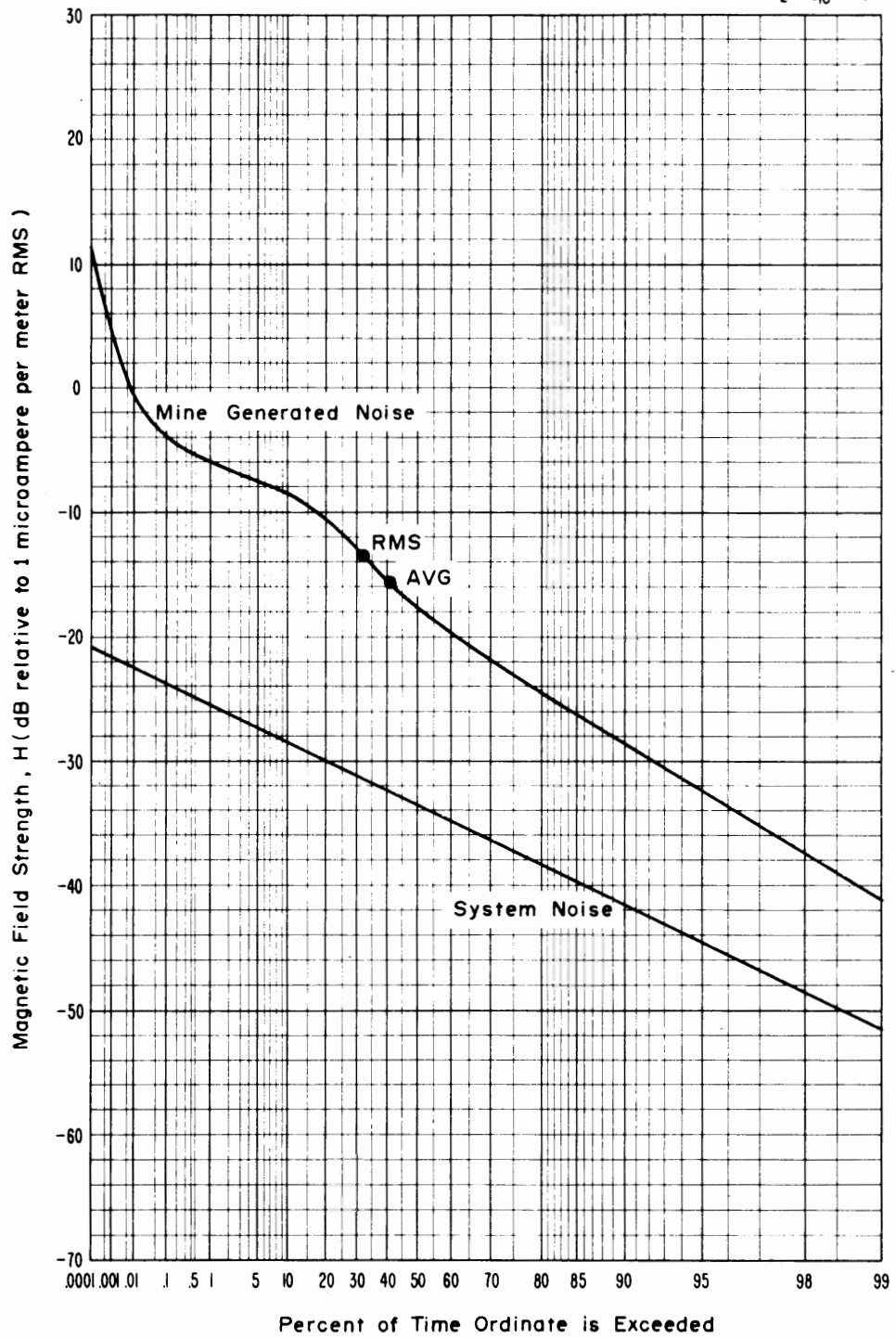

Figure 4-3 APD, 70 kHz, vertical component, 1.0 kHz predetection bandwidth, April 17, 1973, 12:50 p.m., Cabin Creek, Itmann #3.

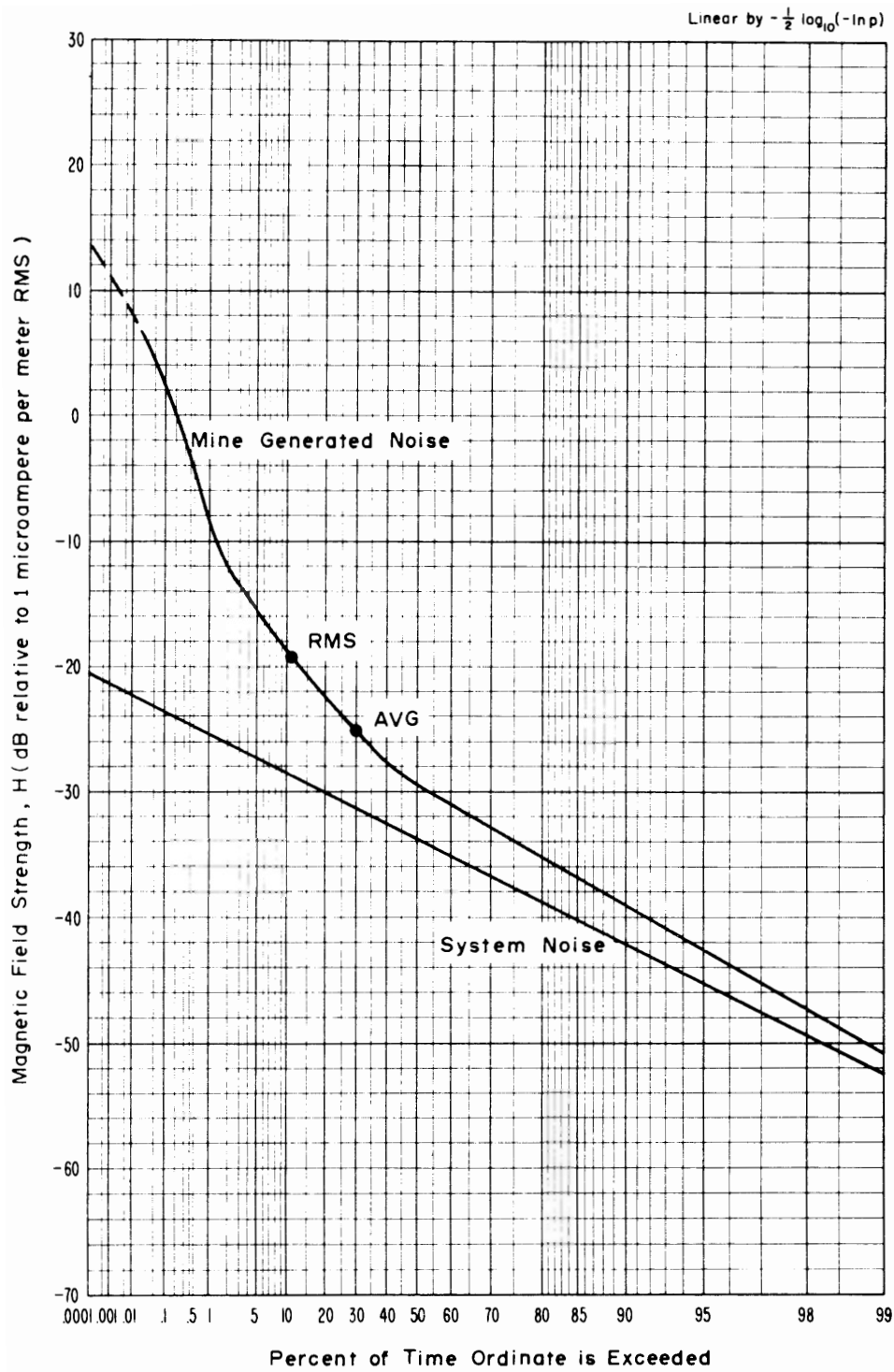

Figure 4-4 APD, 130 kHz, vertical component, 1.0 kHz predetection bandwidth, April 17, 1973, 1:30 p.m., Cabin Creek, Itmann #3.

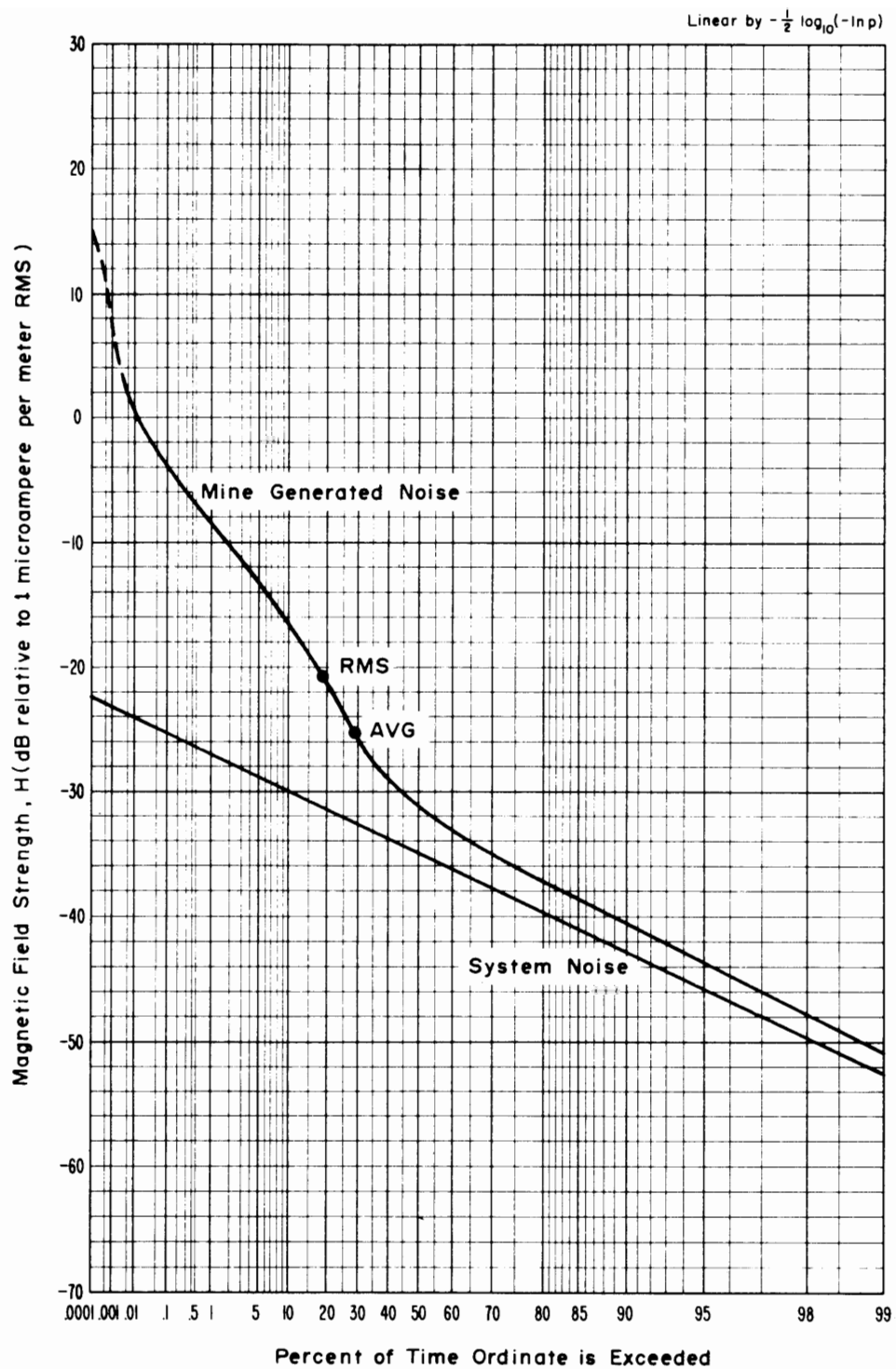

Figure 4-5 APD, 160 kHz, vertical component, 1.0 kHz predetection bandwidth, April 17, 1973, 2:20 p.m., Cabin Creek, Itmann #3.

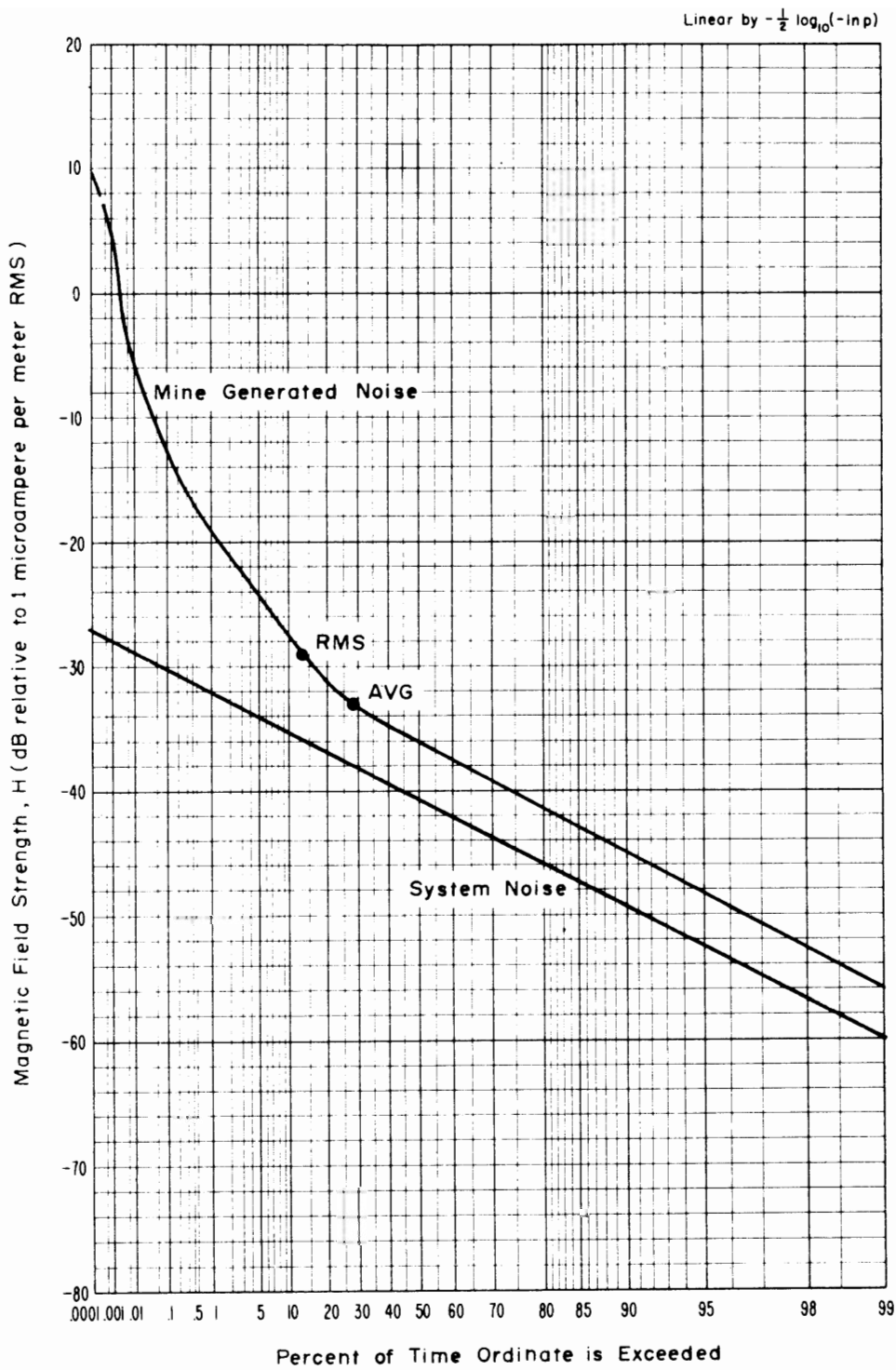

Figure 4-6 APD, 250 kHz, vertical component, 1.0 kHz predetection bandwidth, April 17, 1973, 3:00 p.m., Cabin Creek, Itmann #3.

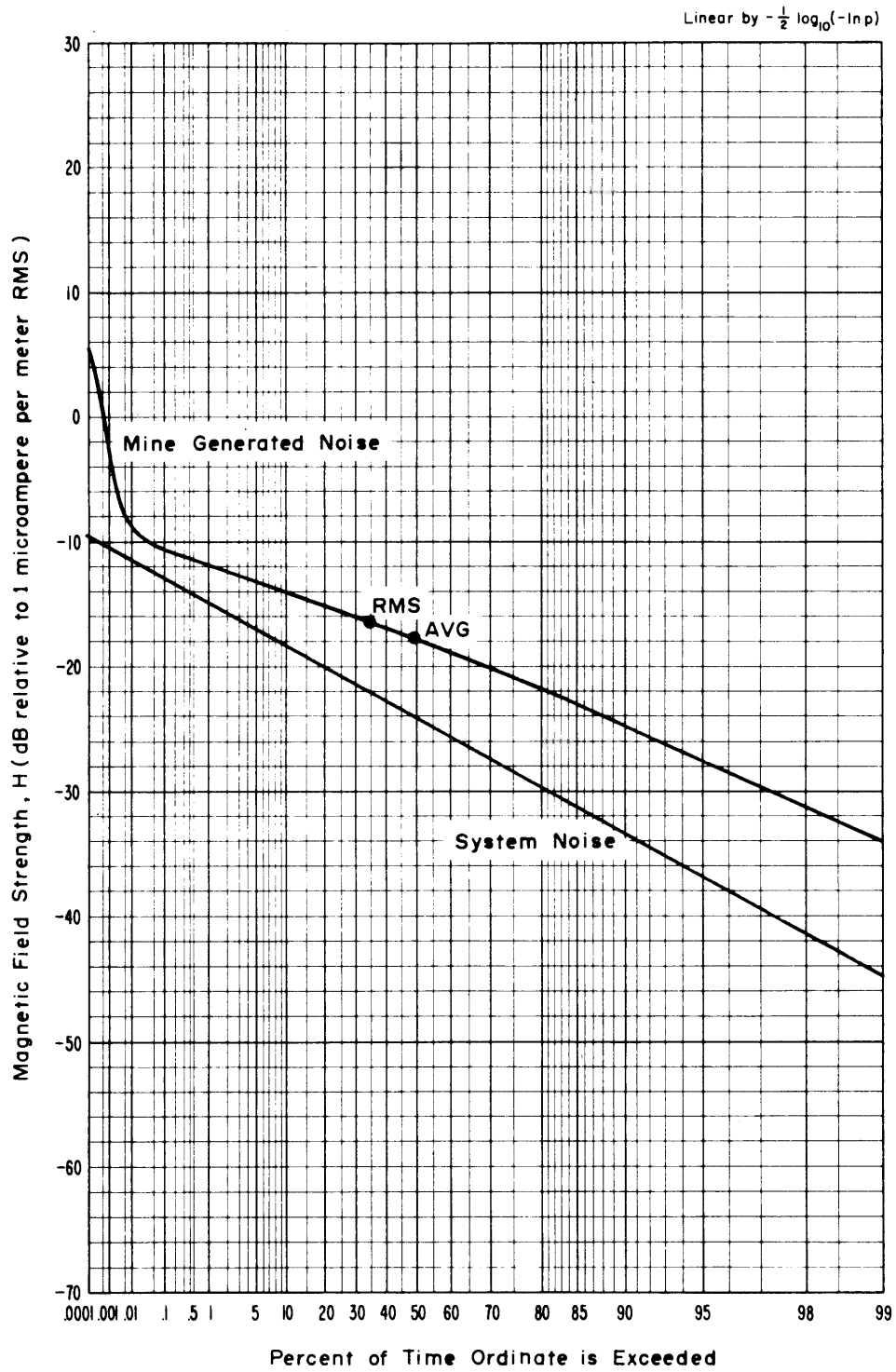

Figure 4-7 APD, 500 kHz, vertical component, 1.2 kHz predetection bandwidth, April 17, 1973, 11:40 a.m., Cabin Creek, Itmann #3.

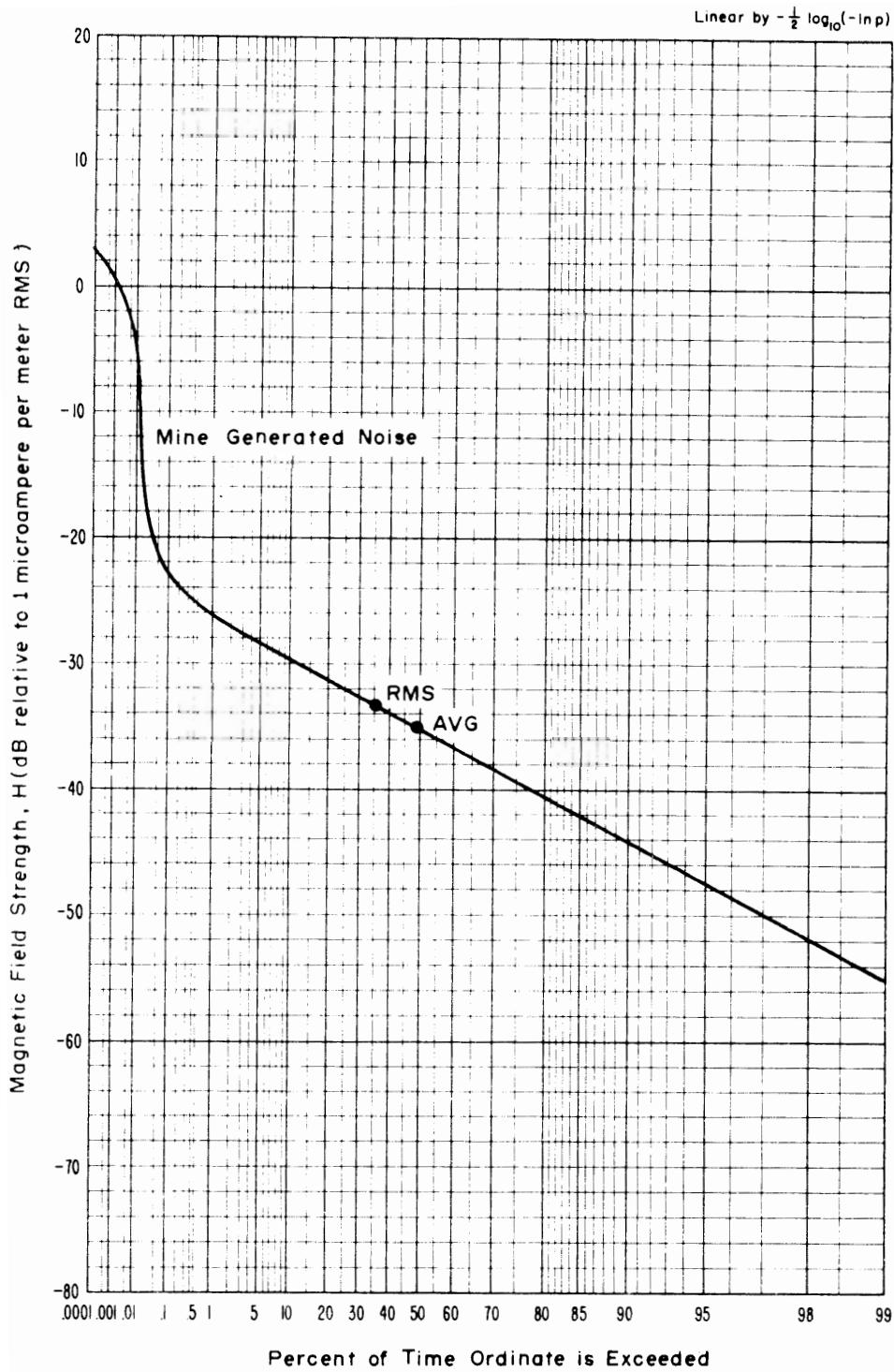

Figure 4-8 APD, 1 MHz, vertical component, 1.2 kHz predetection bandwidth, April 17, 1973, 12:20 p.m., Cabin Creek, Itmann #3.

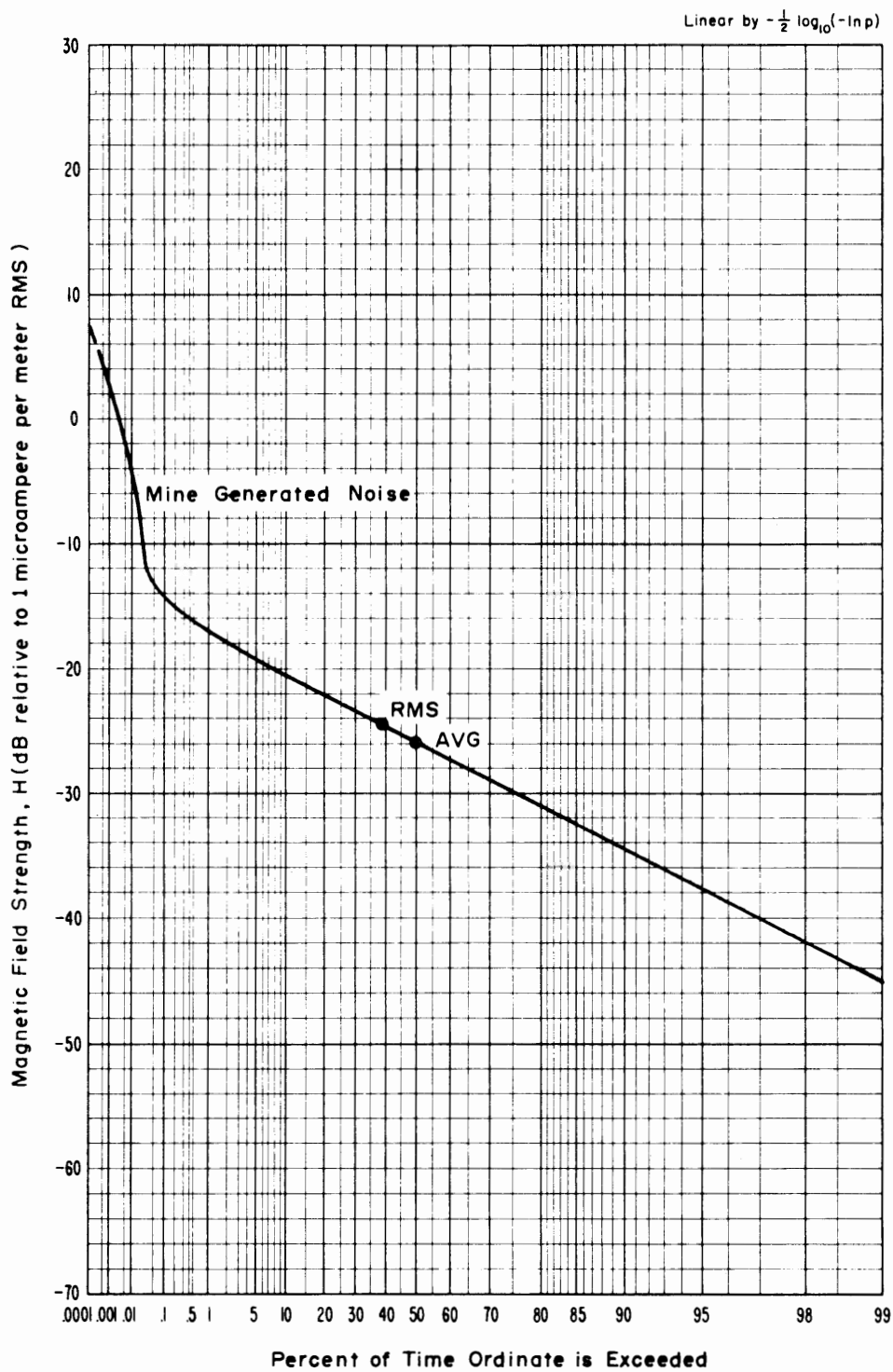

Figure 4-9 APD, 2 MHz, vertical component, 1.2 kHz predetection bandwidth, April 17, 1973, 12:50 p.m., Cabin Creek, Itmann #3.

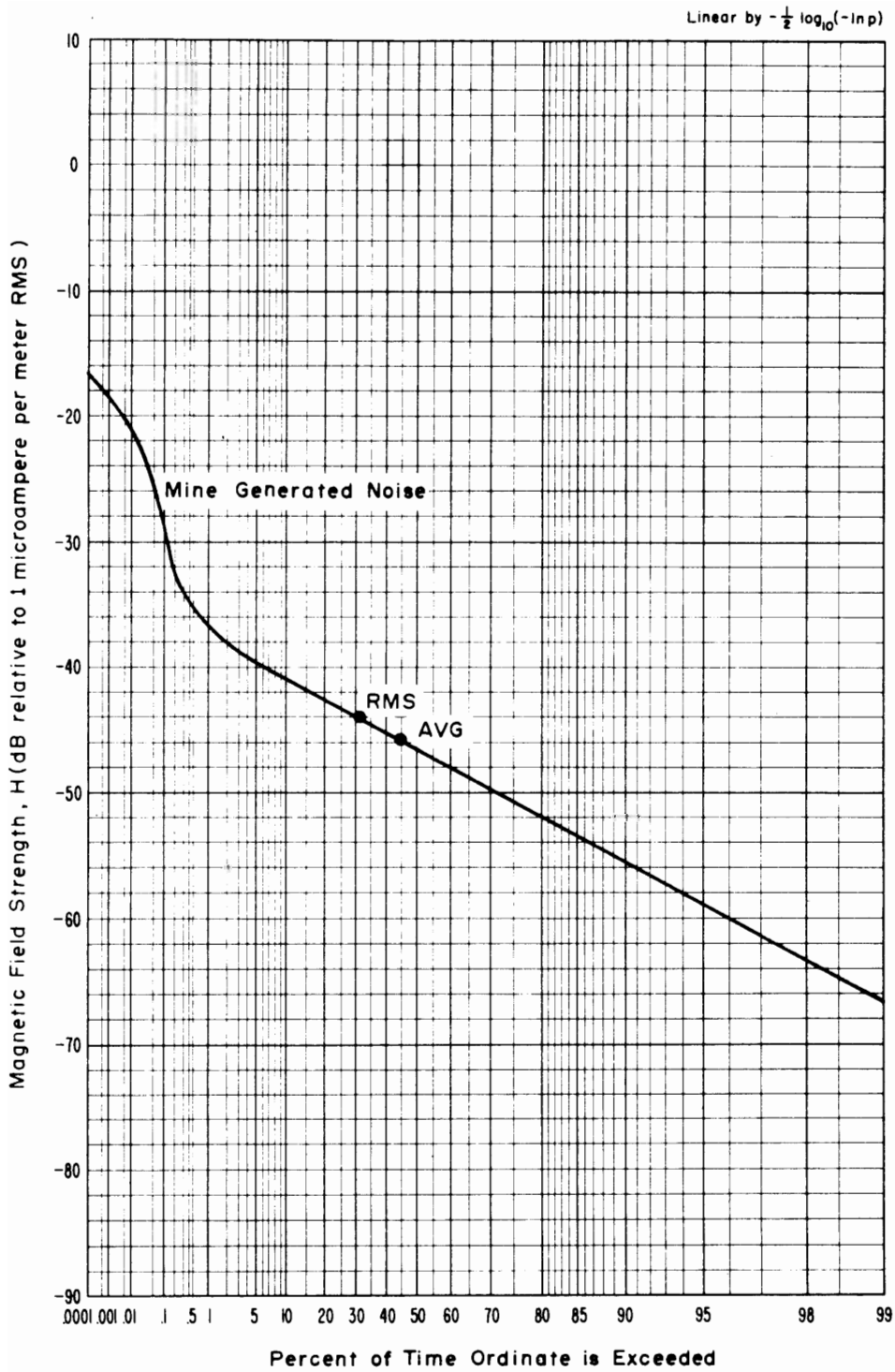

Figure 4-10 APD, 6 MHz, vertical component, 1.2 kHz predetection bandwidth, April 17, 1973, 1:30 p.m., Cabin Creek, Itmann #3.

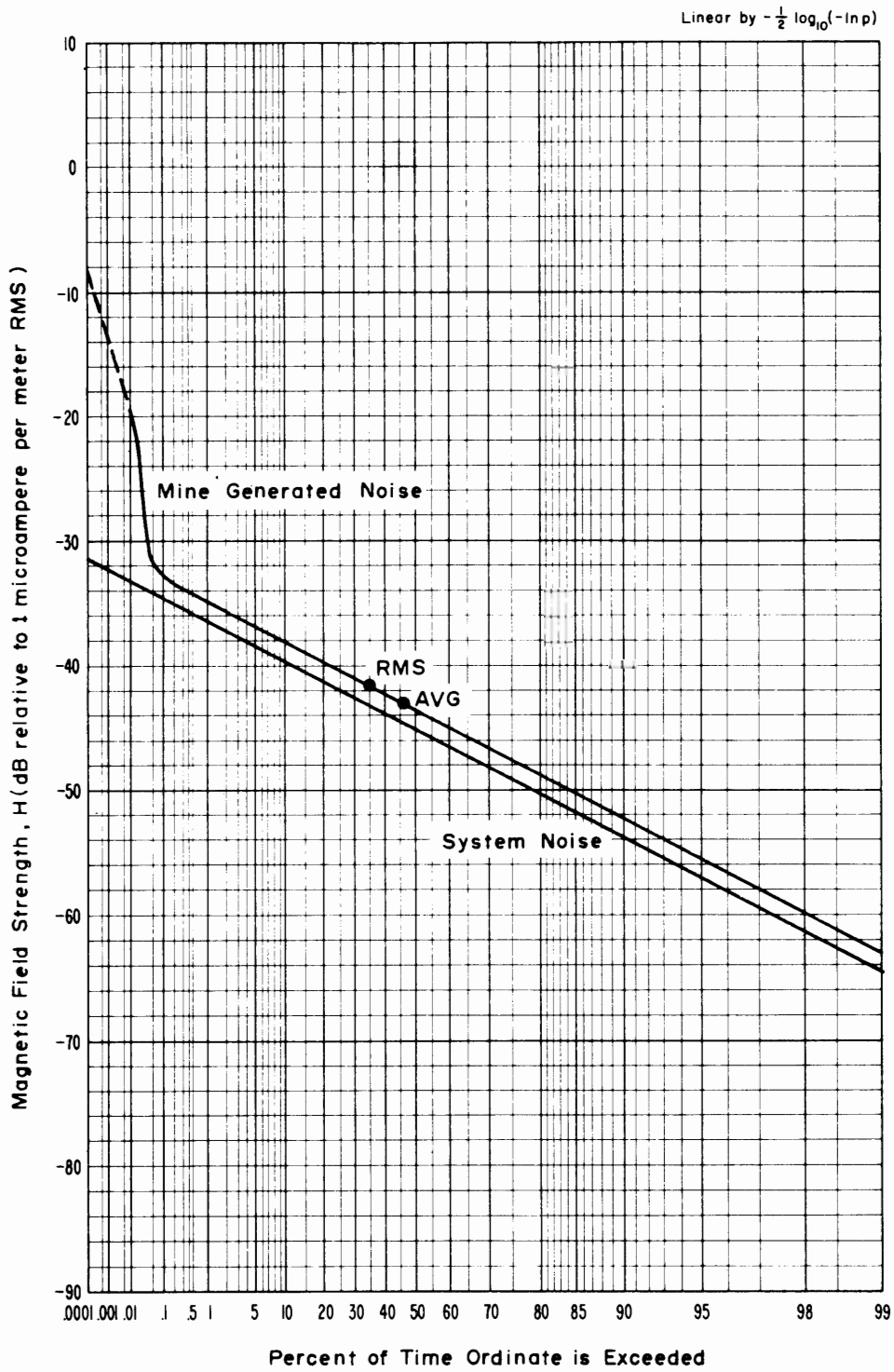

Figure 4-11 APD, 14 MHz, vertical component, 1.2 kHz predetection bandwidth, April 17, 1973, 2:20 p.m., Cabin Creek, Itmann #3.

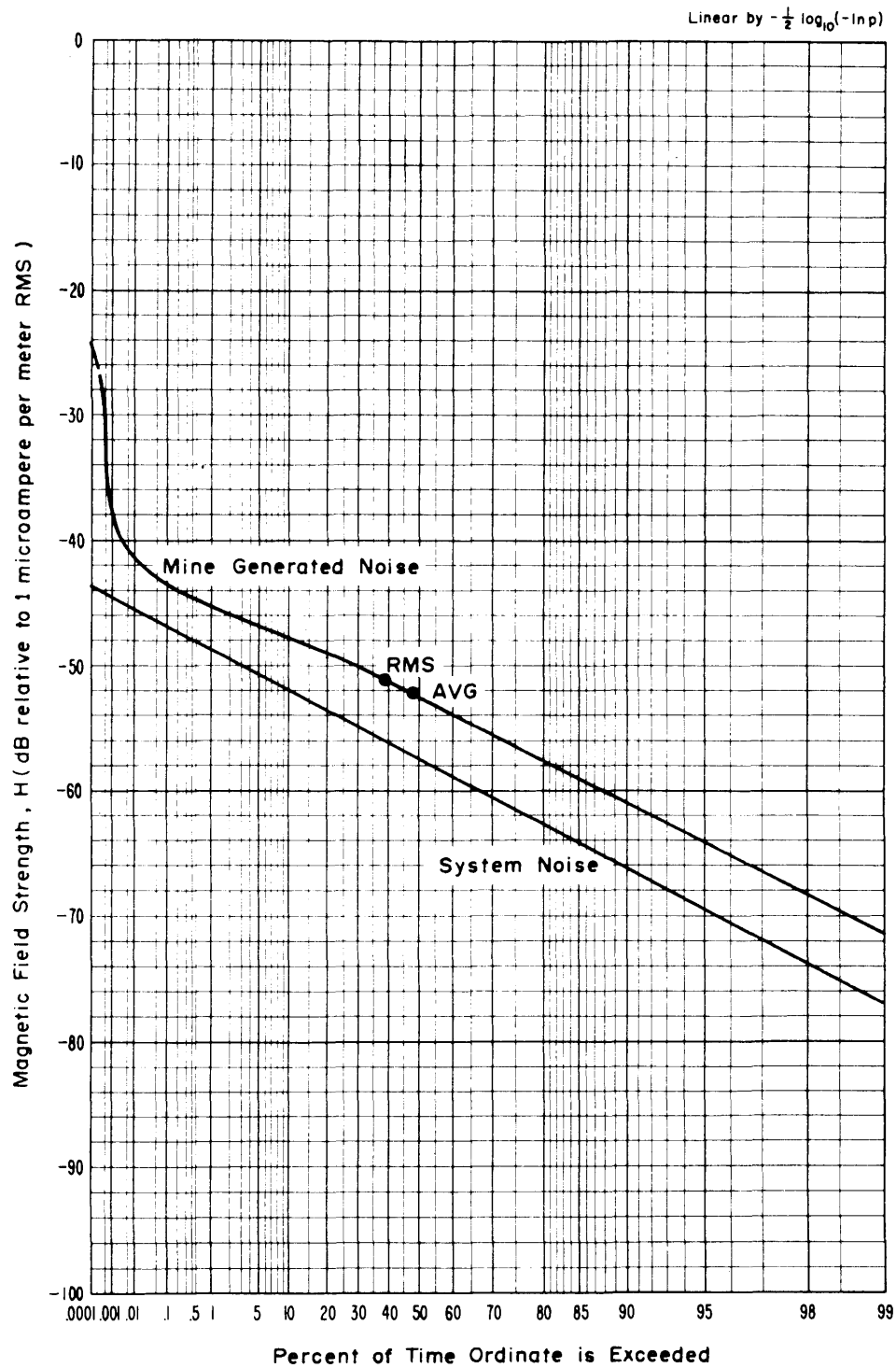

Figure 4-12 APD, 32 MHz, vertical component, 1.2 kHz predetection bandwidth, April 17, 1973, 3:00 p.m., Cabin Creek, Itmann #3.

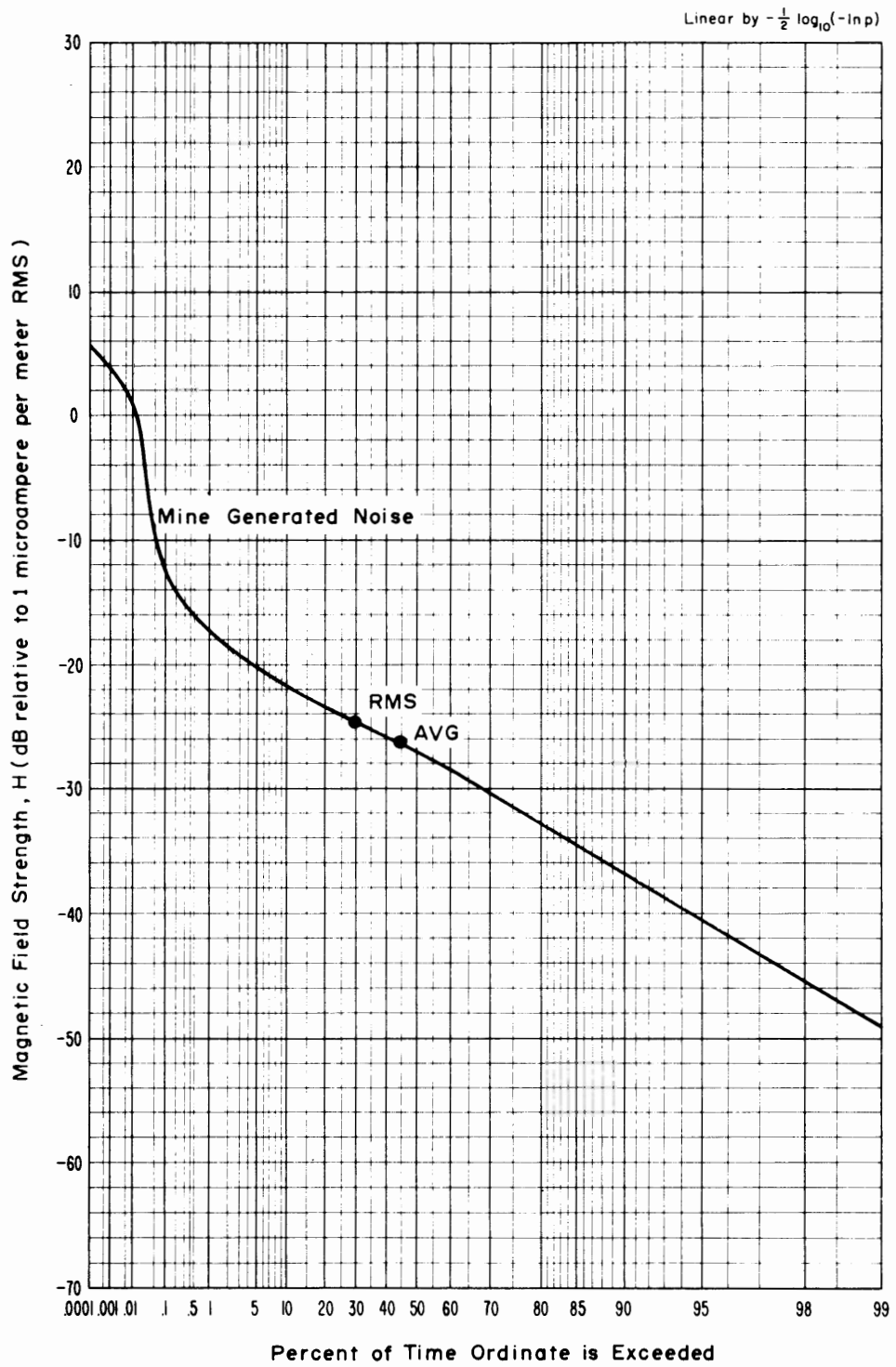

Figure 4-13 APD, 10 kHz, vertical component, 1.0 kHz predetection bandwidth, April 17, 1973, 3:40 p.m., Quiet Time Measurement, Cabin Creek, Itmann #3.

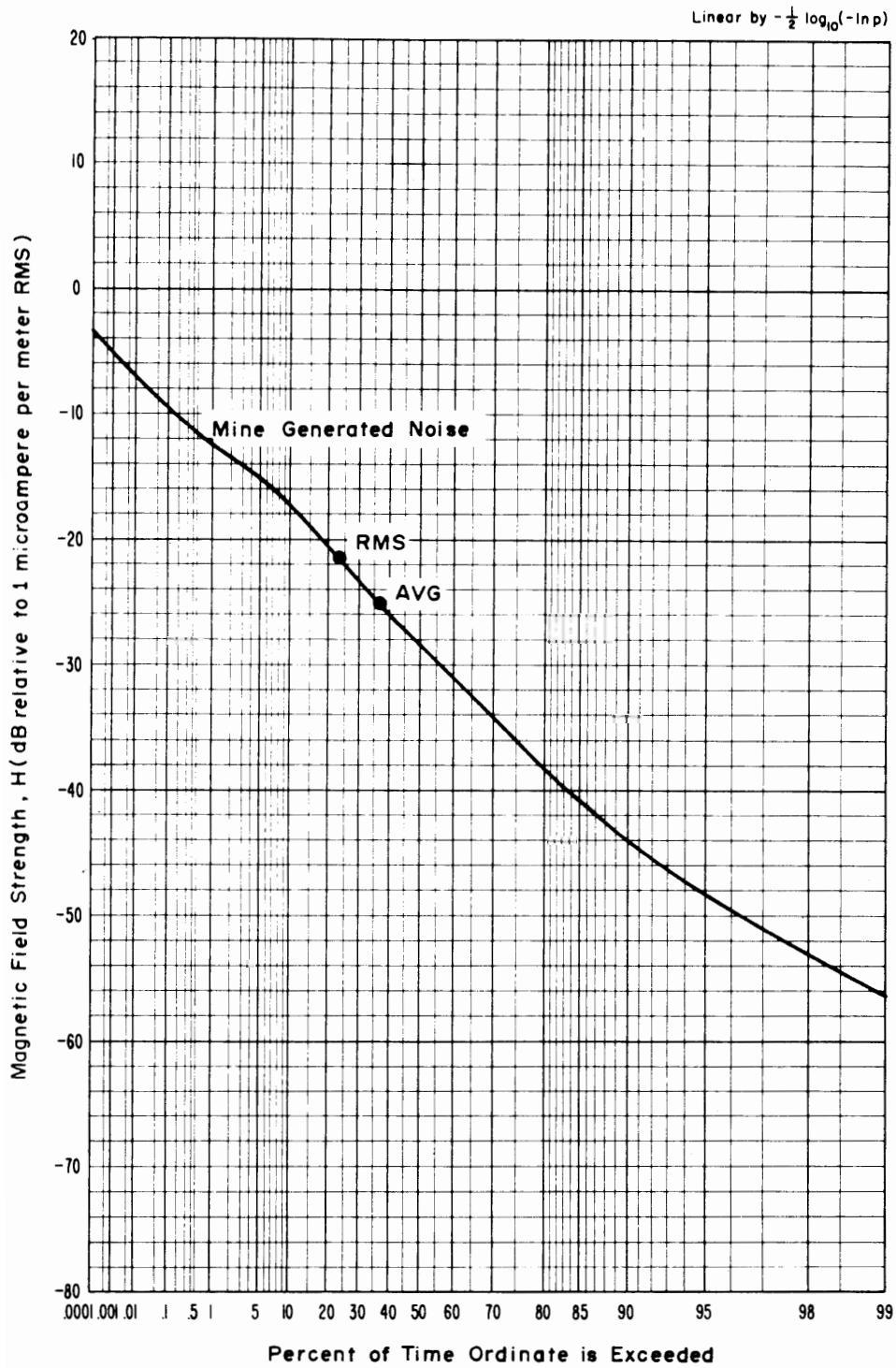

Figure 4-14 APD, 30 kHz, vertical component, 1.0 kHz predetection bandwidth, April 17, 1973, 3:50 p.m., Quiet Time Measurement, Cabin Creek, Itmann #3.

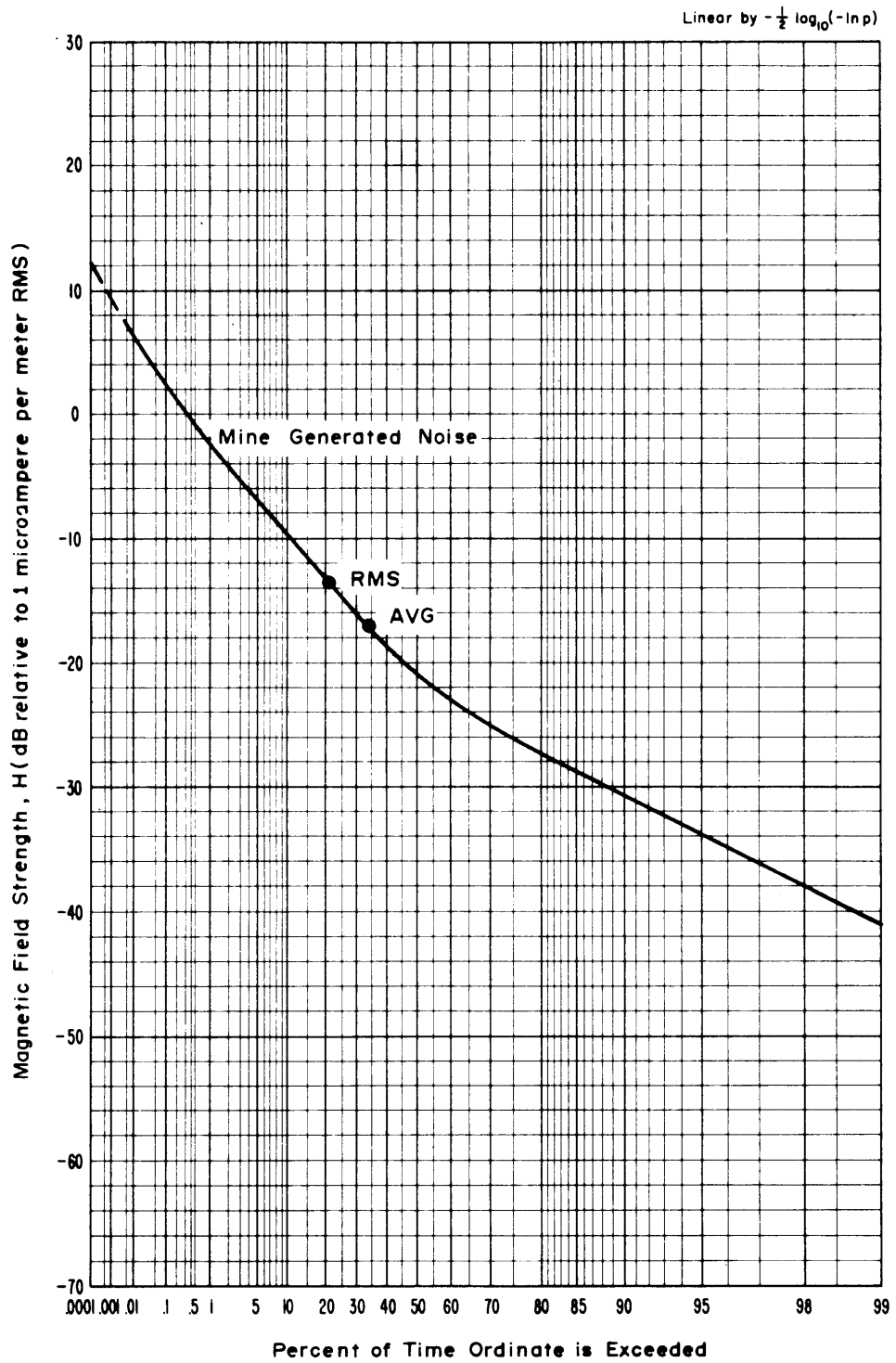

Figure 4-15 APD, 130 kHz, vertical component, 1.0 kHz predetection bandwidth, April 17, 1973, 4:05 p.m., Quiet Time Measurement, Cabin Creek, Itmann #3.

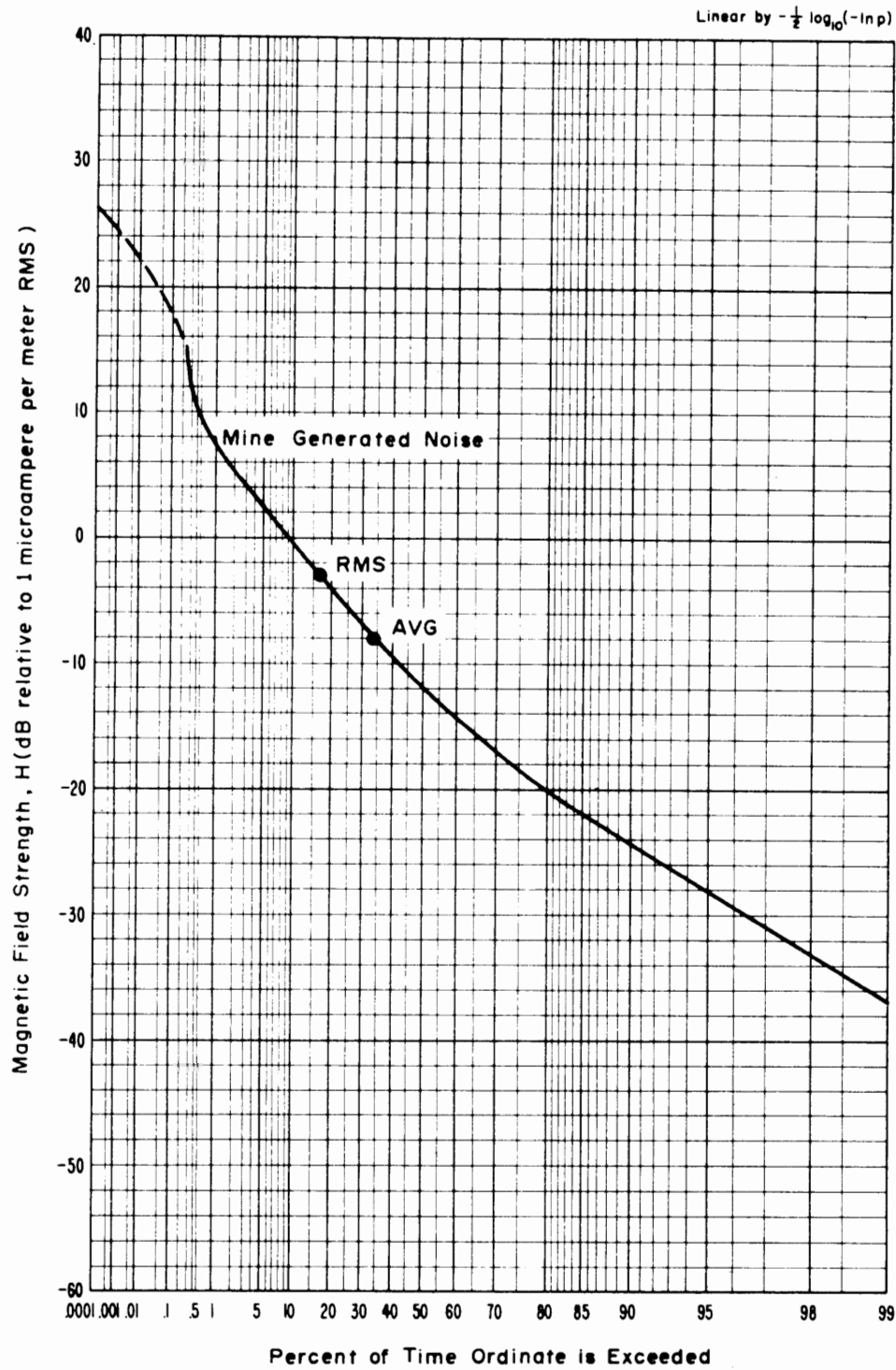

Figure 4-16 APD, 500 kHz, vertical component, 1.2 kHz predetection bandwidth, April 17, 1973, 3:40 p.m., Quiet Time Measurement, Cabin Creek, Itmann #3.

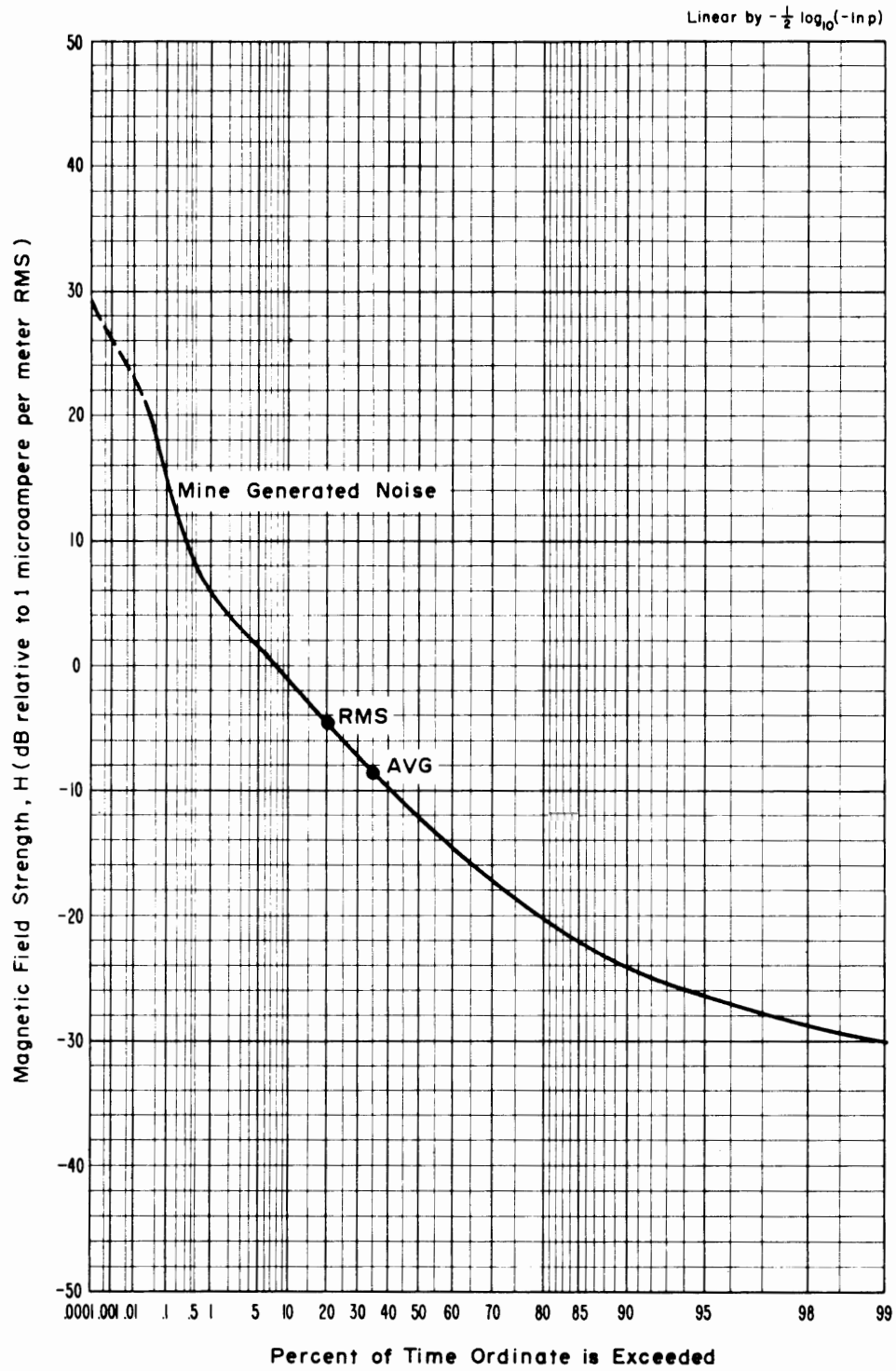

Figure 4-17 APD, 1 MHz, vertical component, 1.2 kHz predetection bandwidth, April 17, 1973, 3:50 p.m., Quiet Time Measurement, Cabin Creek, Itmann #3.

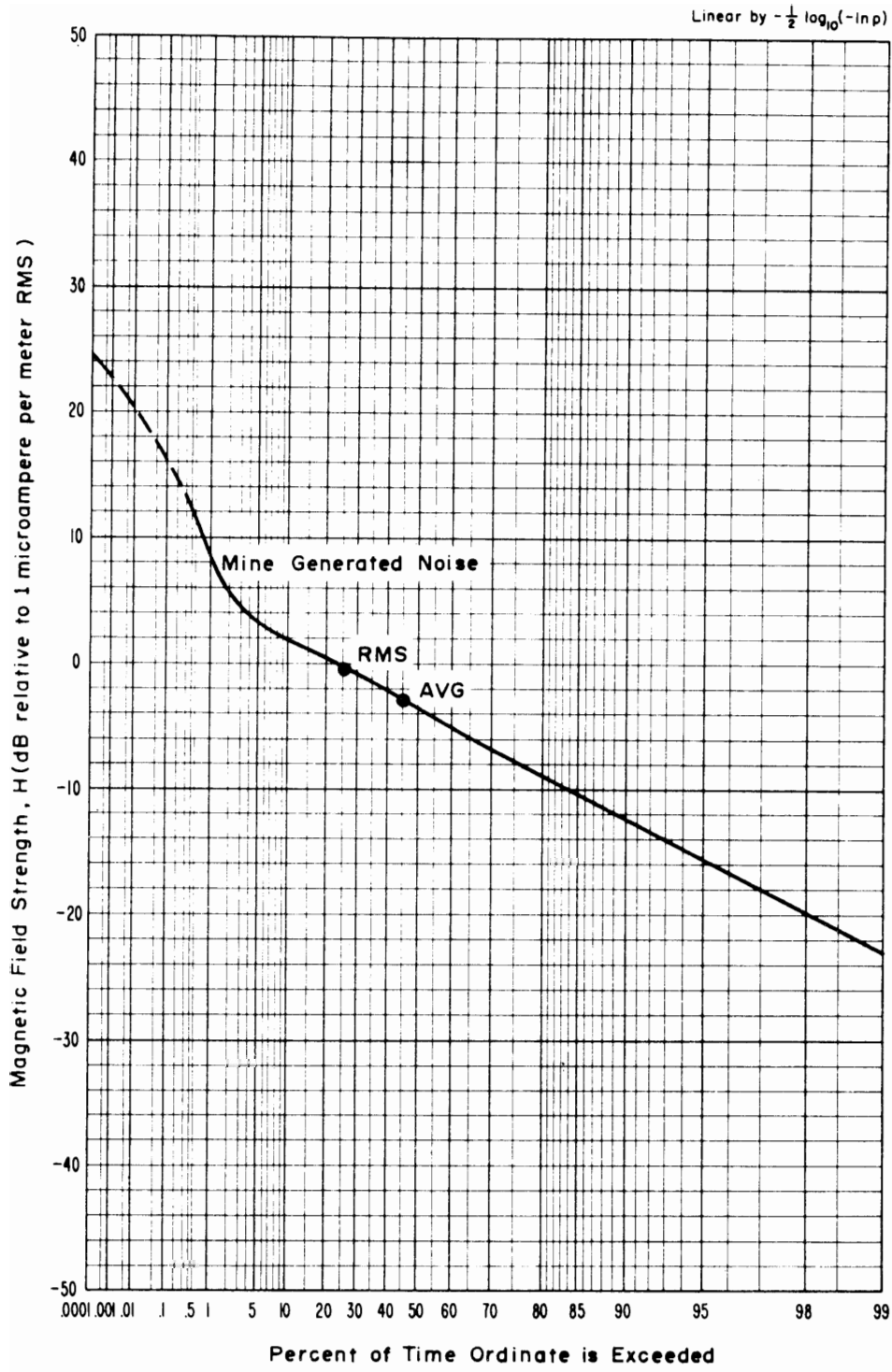

Figure 4-18 APD, 2 MHz, vertical component, 1.2 kHz predetection bandwidth, April 17, 1973, 4:00 p.m., Quiet Time Measurement, Cabin Creek, Itmann #3.

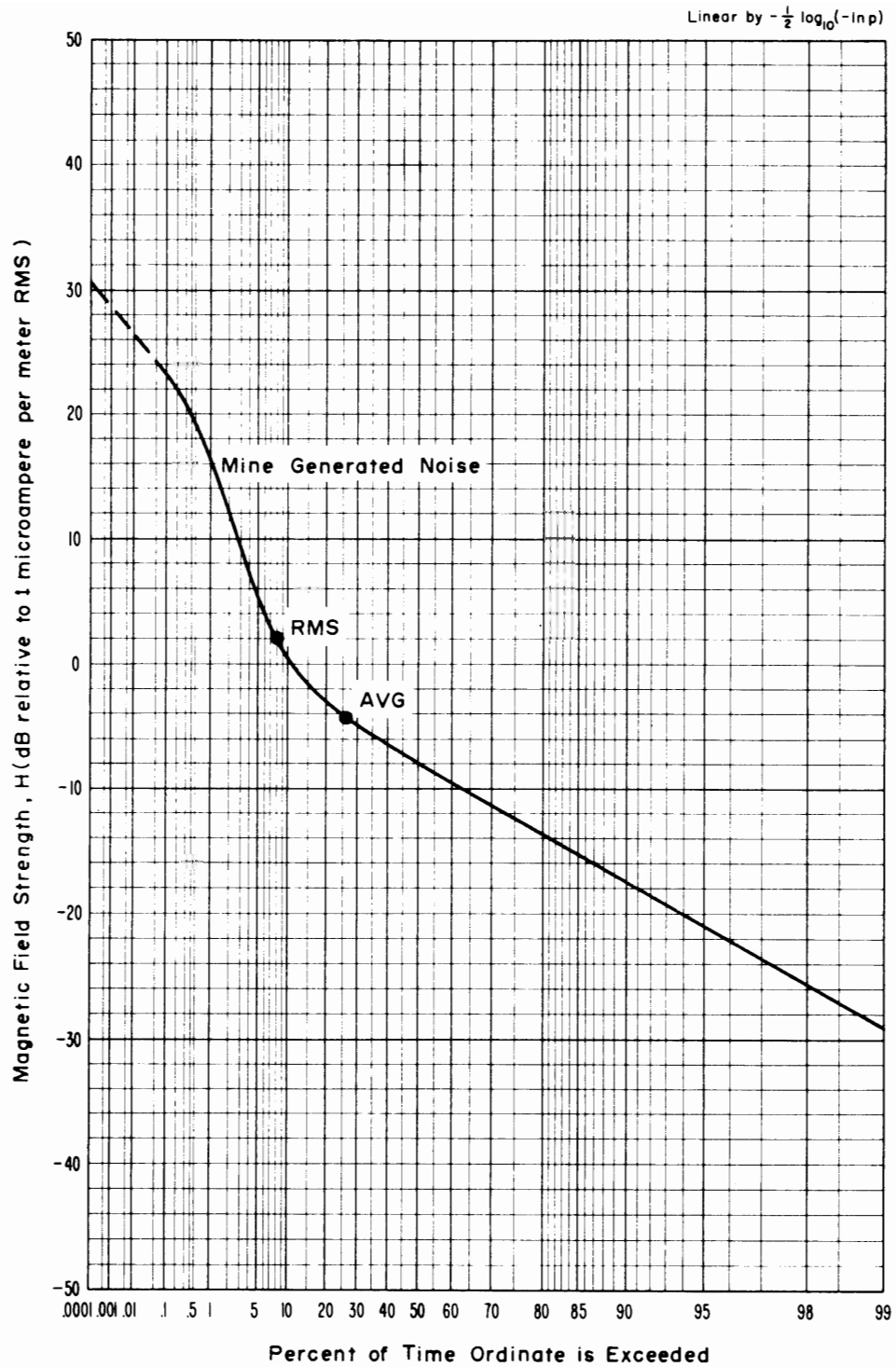

Figure 4-19 APD, 6 MHz, vertical component, 1.2 kHz predetection bandwidth, April 17, 1973, 4:05 p.m., Quiet Time Measurement, Cabin Creek, Itmann #3.

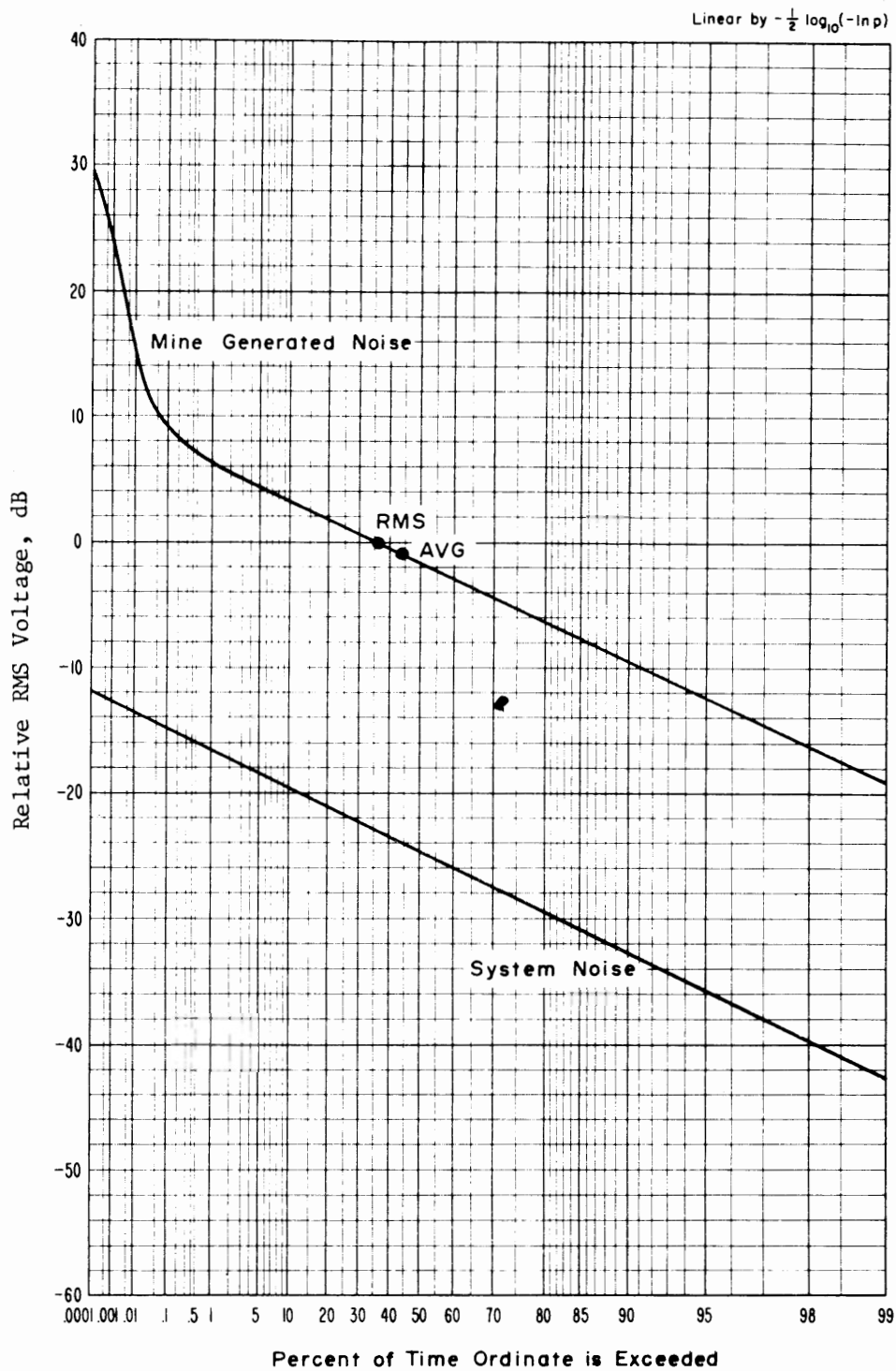

Figure 4-20 APD, 10 kHz, roof bolt measurement, 1.0 kHz predetection bandwidth, April 17, 1973, 5:00 p.m., Cabin Creek, Itmann #3.

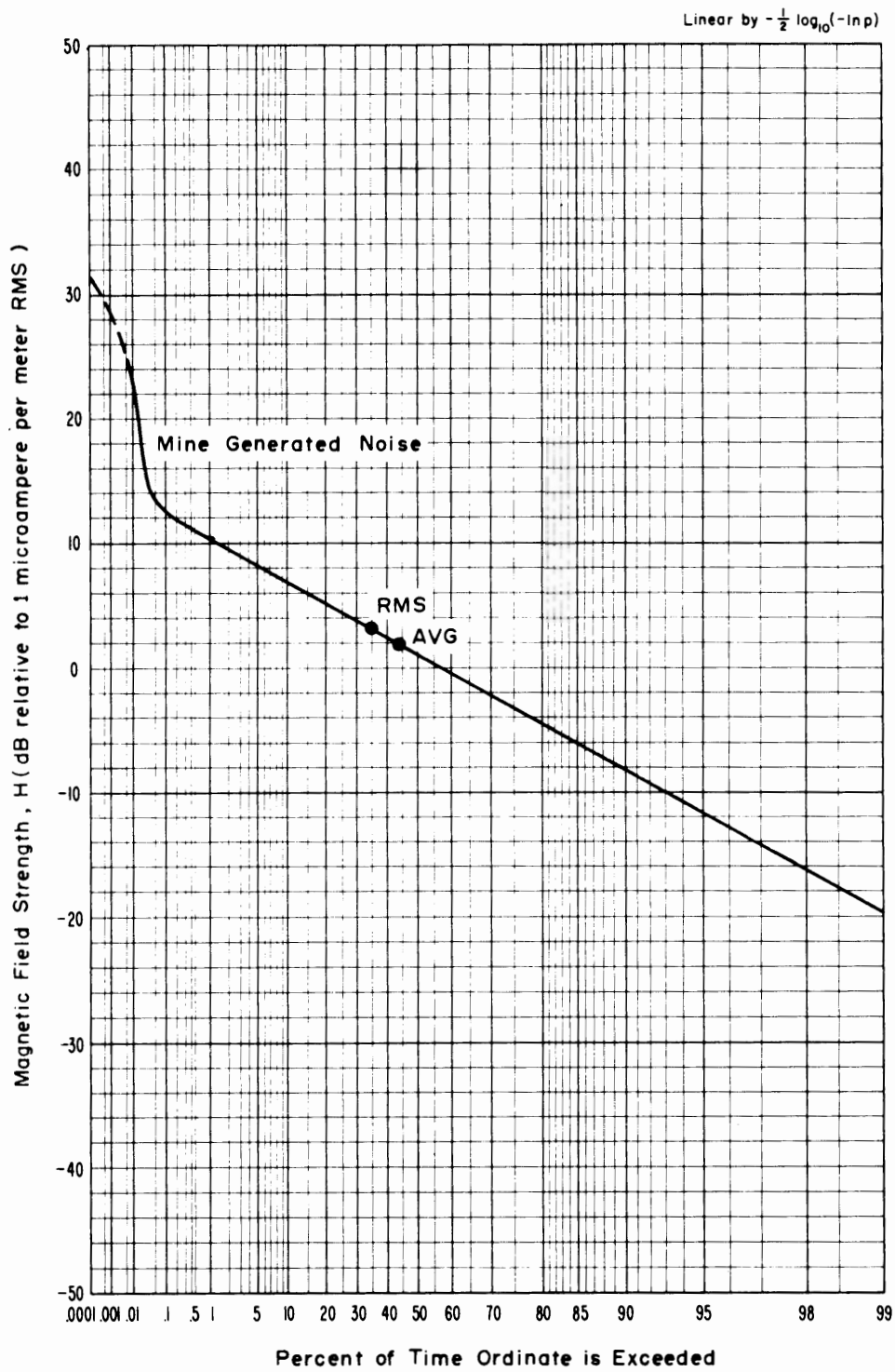

Figure 4-21 APD, 10 kHz, vertical component, 1.0 kHz predetection bandwidth, April 17, 1973, 12:30 p.m., Farley Panel, Itmann #3.

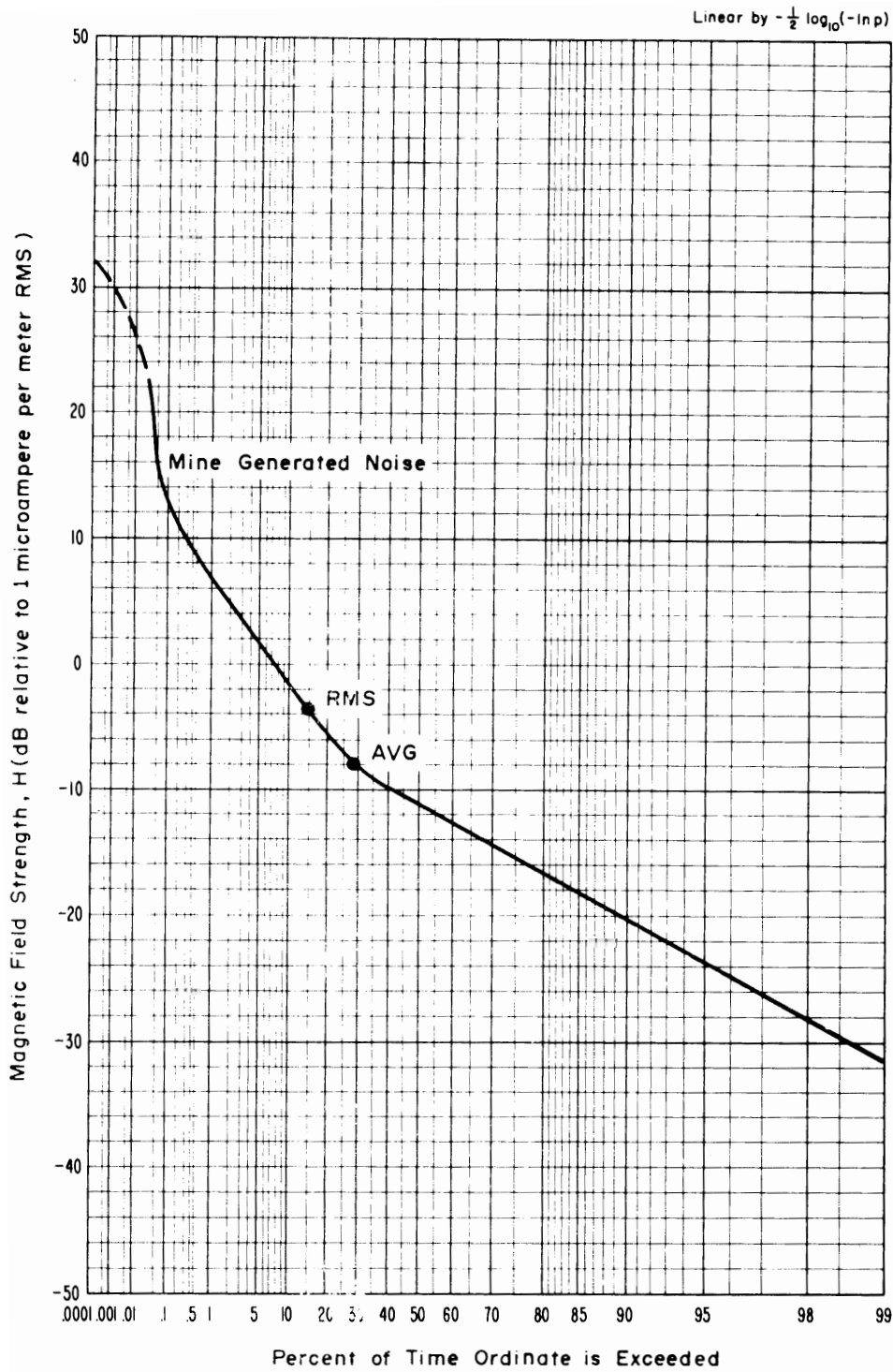

Figure 4-22 APD, 30 kHz, vertical component, 1.0 kHz predetection bandwidth, April 17, 1973, 1:15 p.m., Farley Panel, Itmann #3.

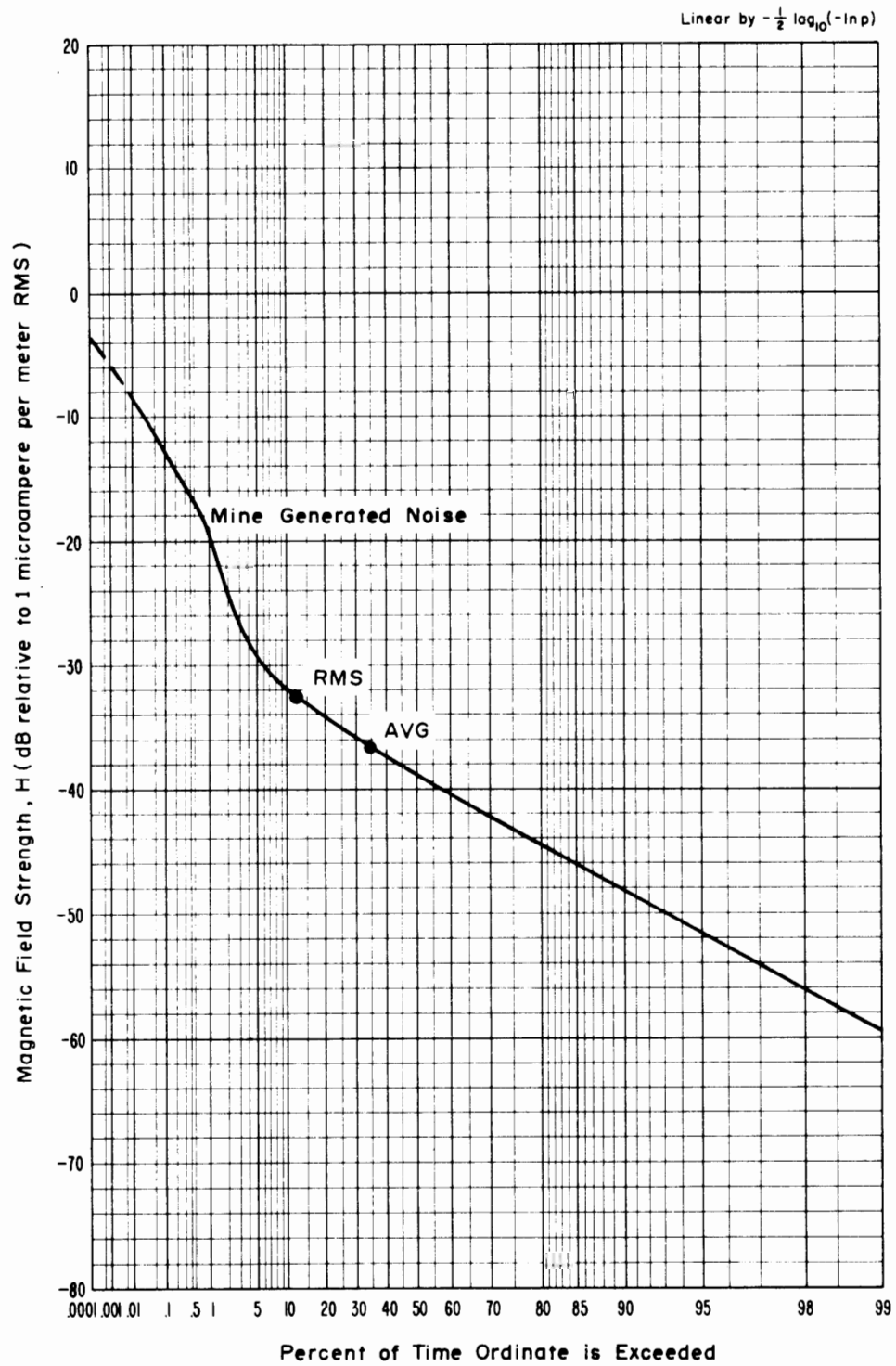

Figure 4-23 APD, 70 kHz, vertical component, 1.0 kHz predetection bandwidth, April 17, 1973, 2:00 p.m., Farley Panel, Itmann #3.

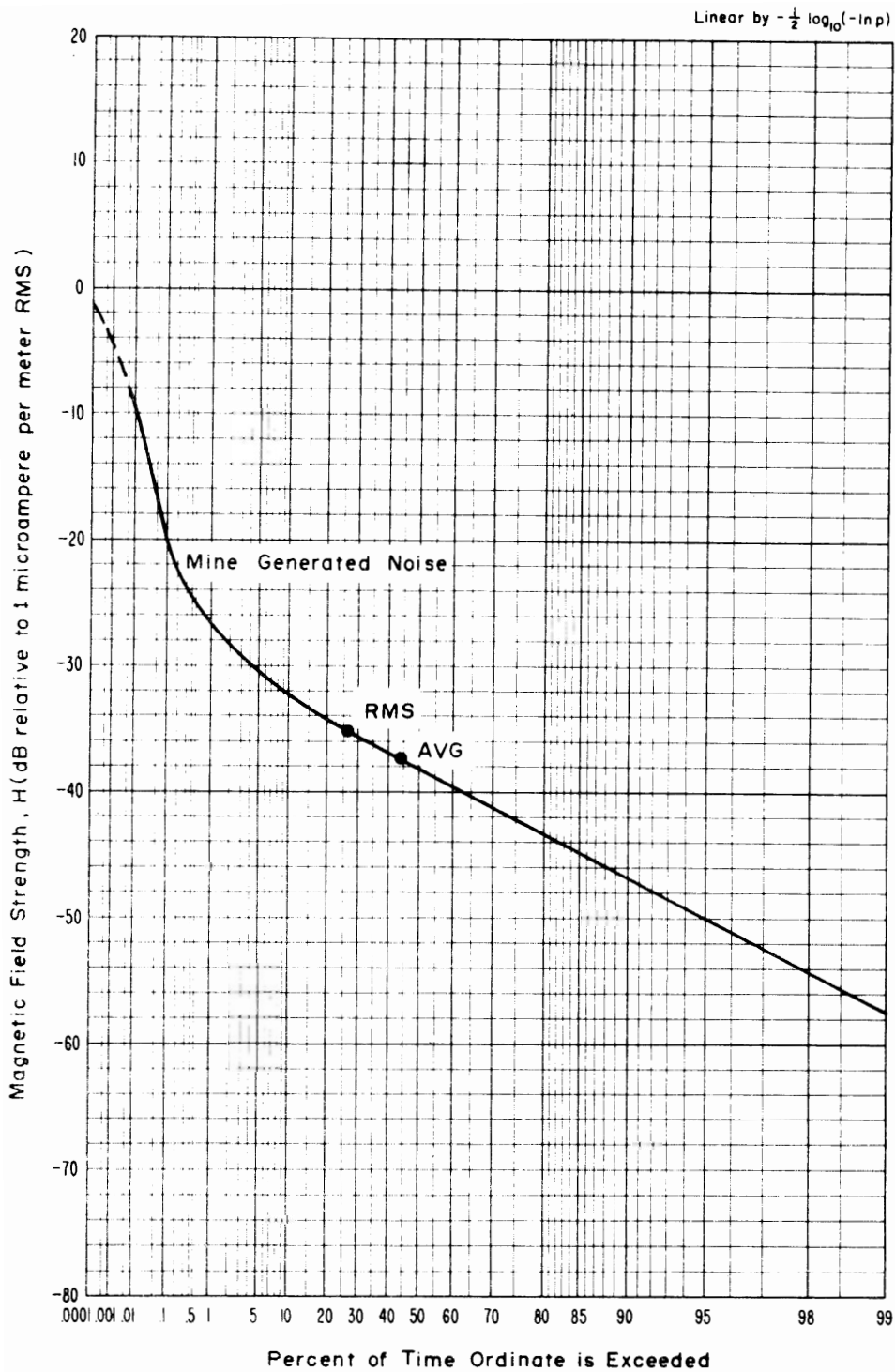

Figure 4-24 APD, 130 kHz, vertical component, 1.0 kHz predetection bandwidth, April 17, 1973, 2:45 p.m., Farley Panel, Itmann #3.

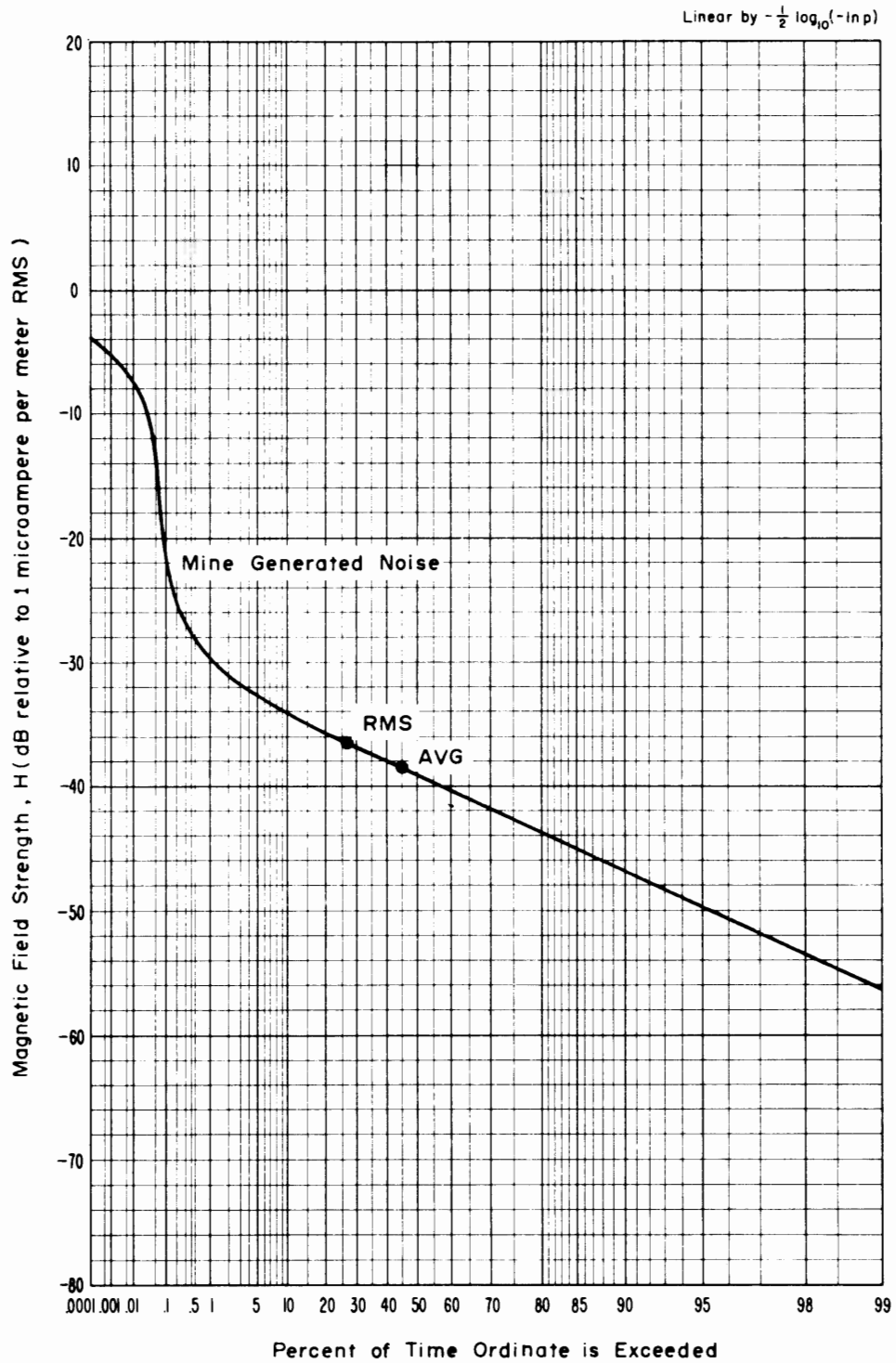

Figure 4-25 APD, 250 kHz, vertical component, 1.2 kHz predetection bandwidth, April 17, 1973, 12:30 p.m., Farley Panel, Itmann #3.

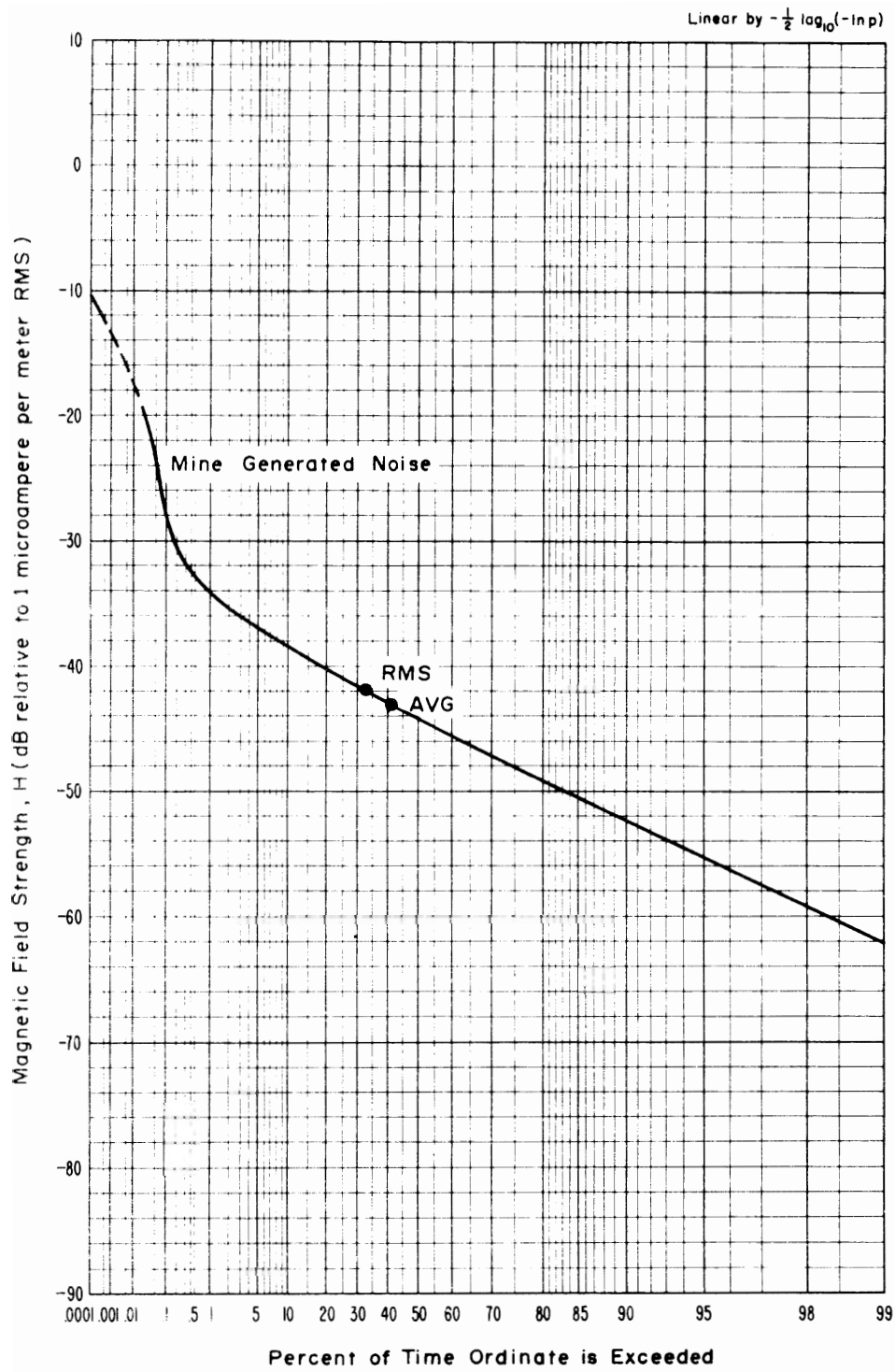

Figure 4-26 APD, 500 kHz, vertical component, 1.2 kHz predetection bandwidth, April 17, 1973, 1:15 p.m., Farley Panel, Itmann #3.

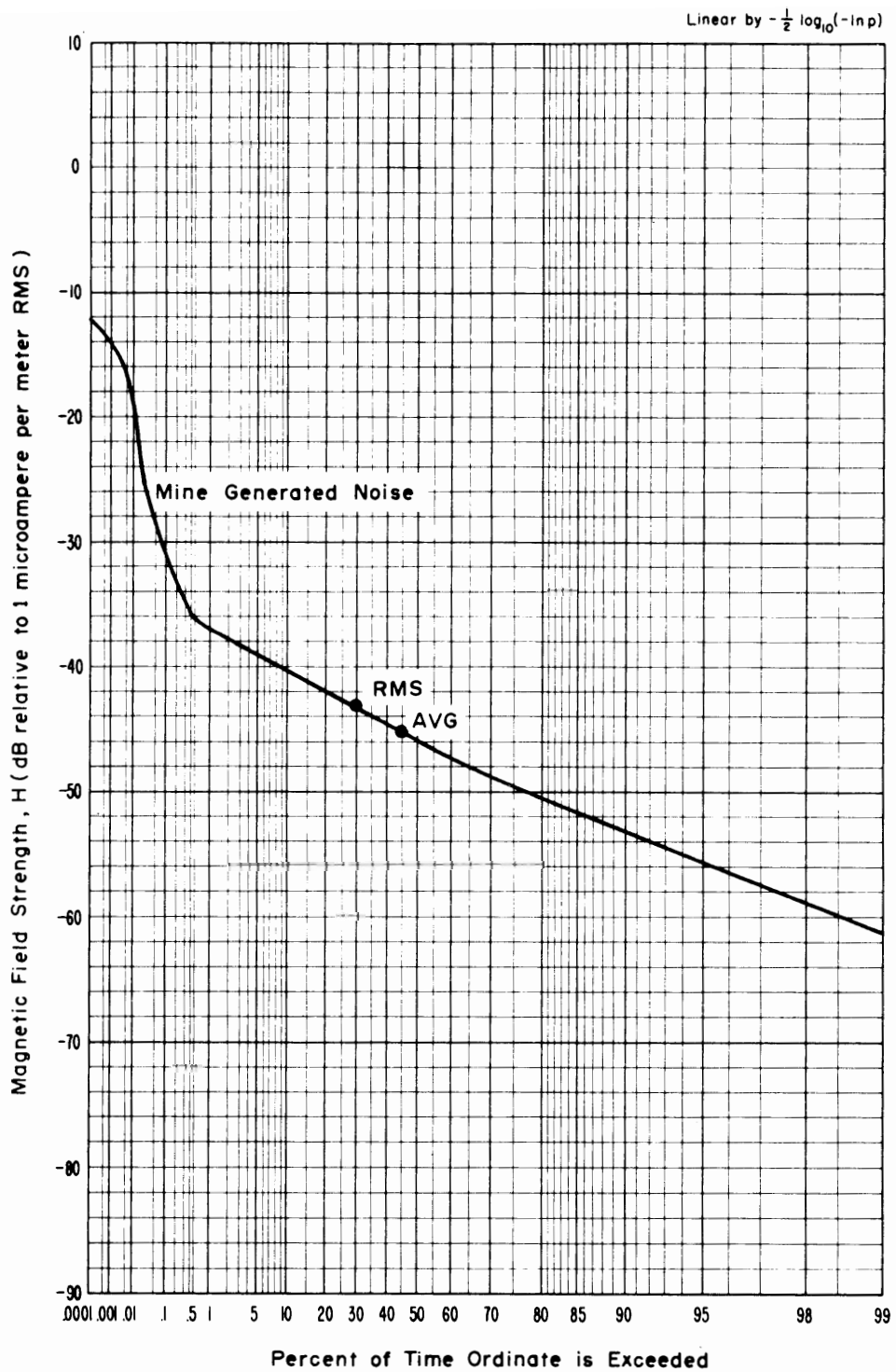

Figure 4-27 APD, 1 MHz, vertical component, 1.2 kHz predetection bandwidth, April 17, 1973, 2:00 p.m., Farley Panel, Itmann #3.

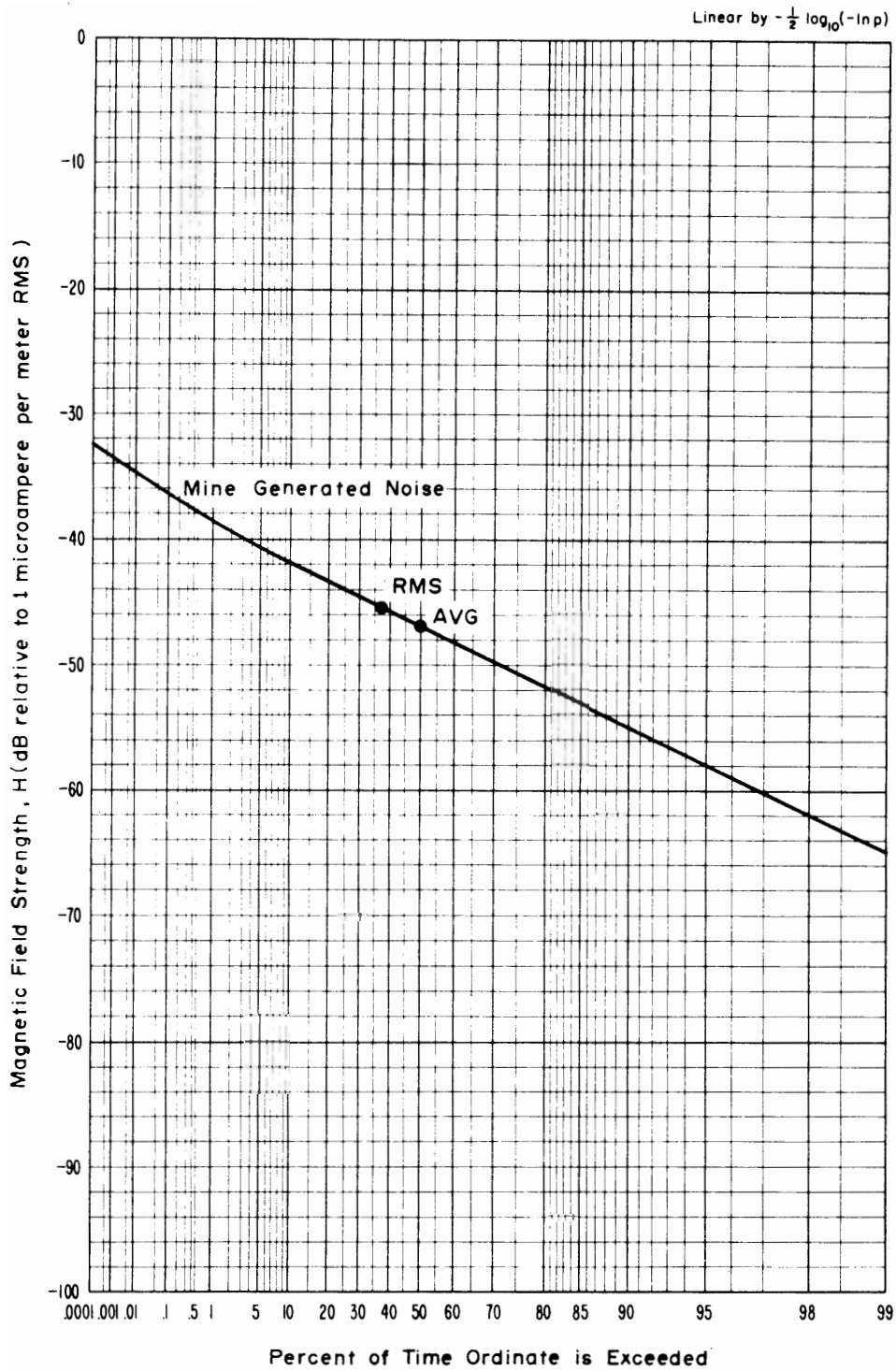

Figure 4-28 APD, 2 MHz, vertical component, 1.2 kHz predetection bandwidth, April 17, 1973, 2:45 p.m., Farley Panel, Itmann #3.

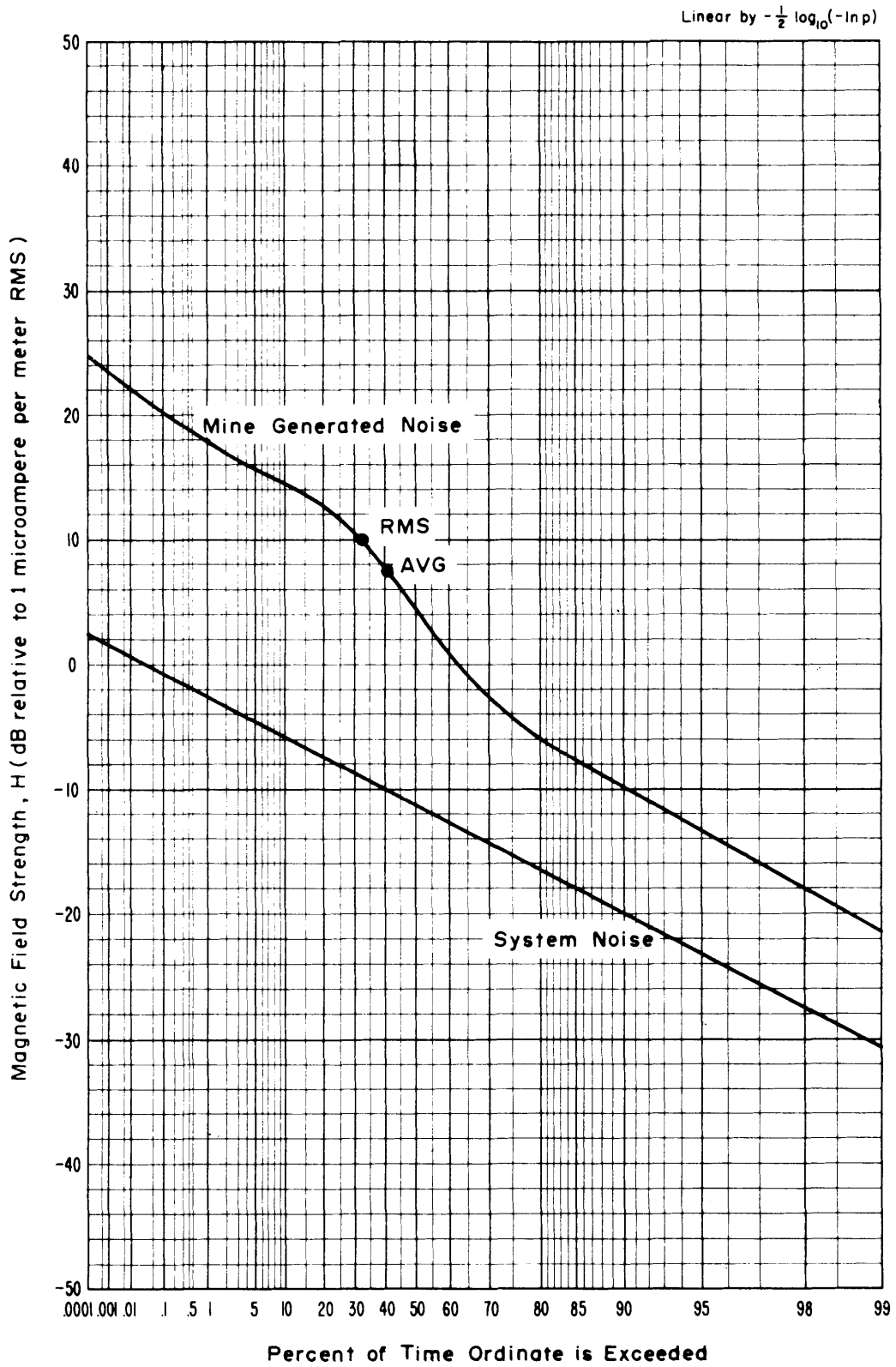

Figure 4-29 APD, 10 kHz, vertical component, 1.0 kHz predetection bandwidth, April 19, 1973, 10:20 a.m., Farley Headpiece, Itmann #3.

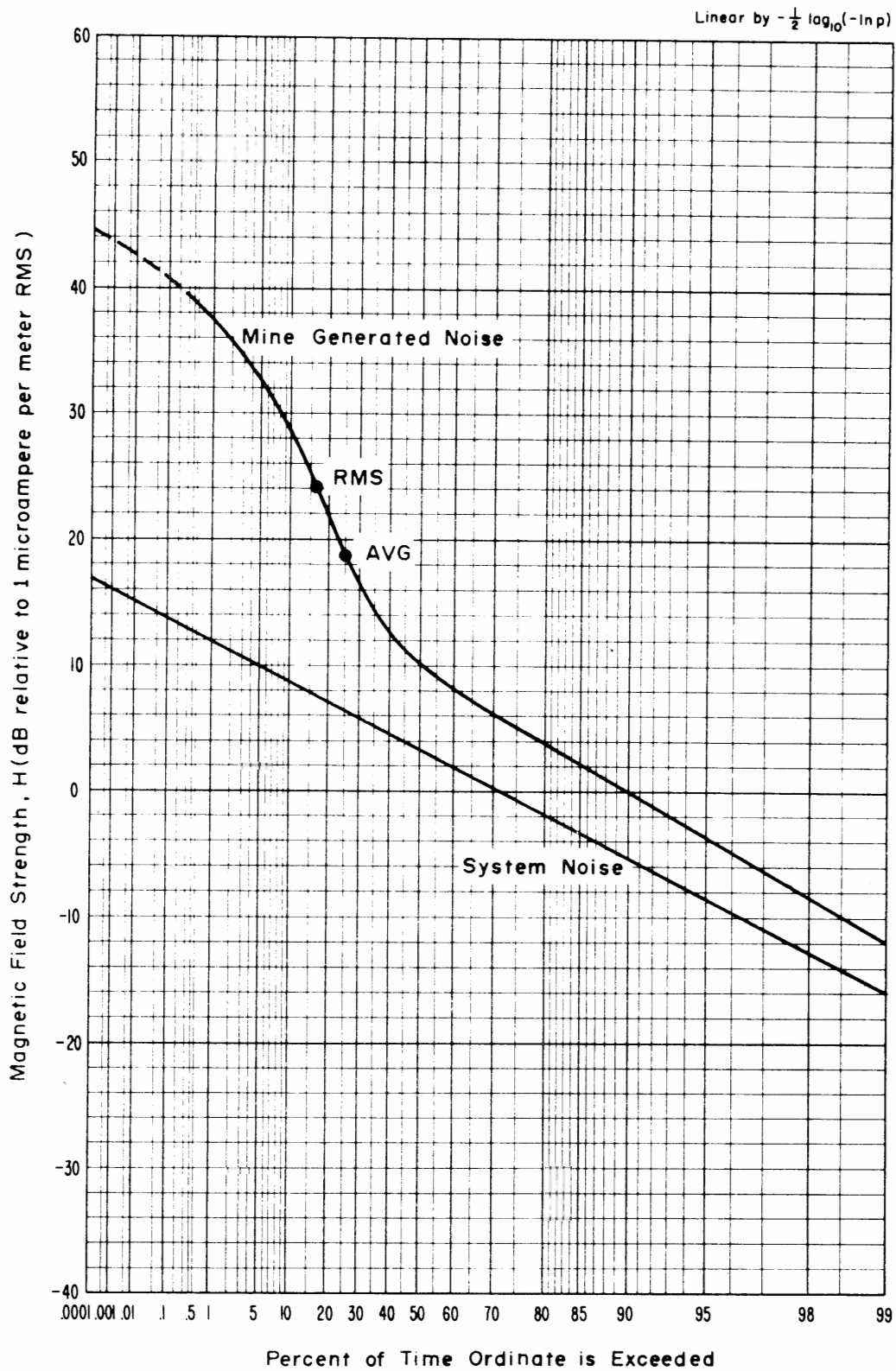

Figure 4-30 APD, 30 kHz, vertical component, 1.0 kHz predetection bandwidth, April 19, 1973, 10:50 a.m., Farley Headpiece, Itmann #3.

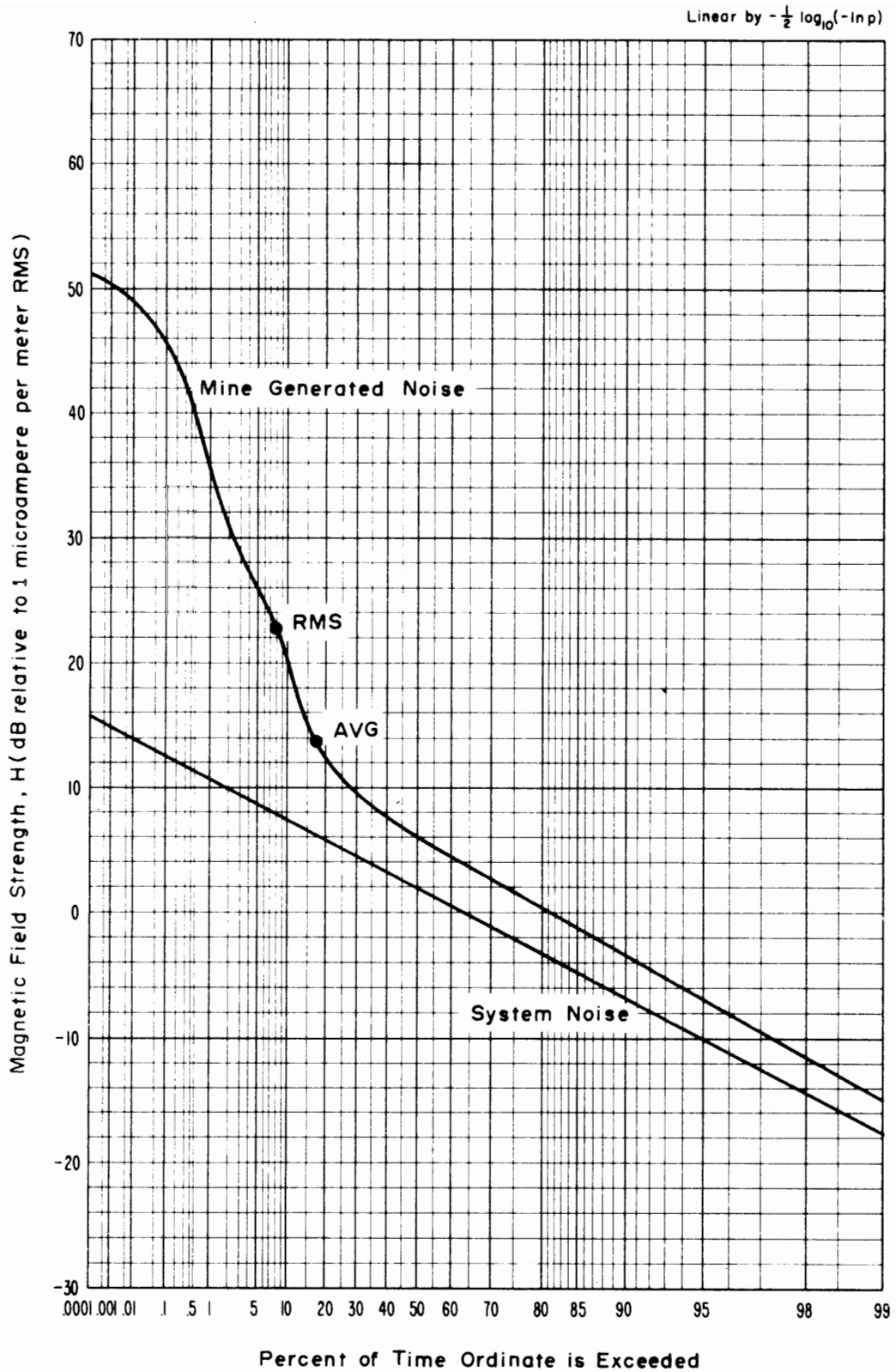

Figure 4-31 APD, 70 kHz, vertical component, 1.0 kHz predetection bandwidth, April 19, 1973, 11:25 a.m., Farley Headpiece, Itmann #3.

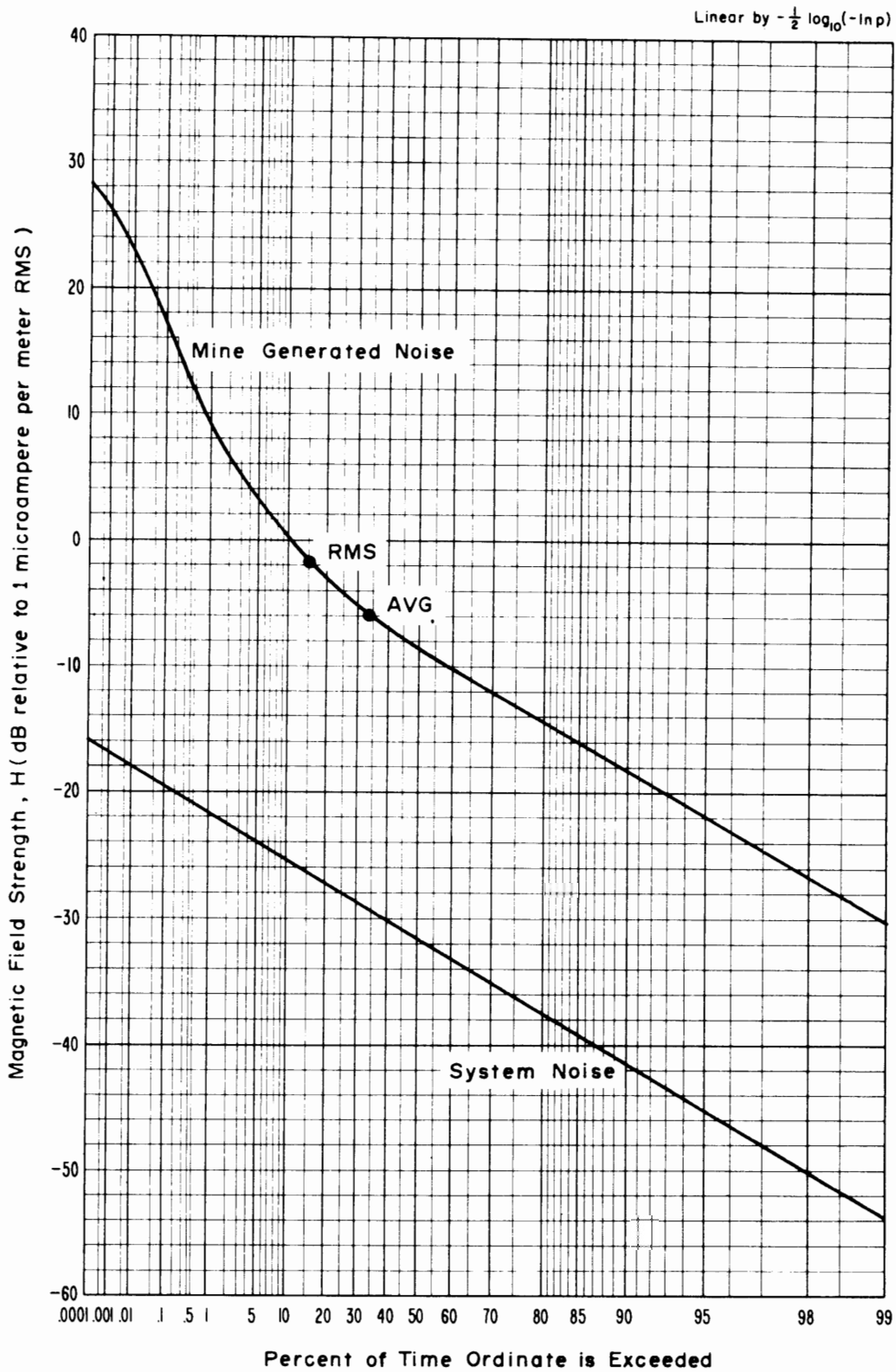

Figure 4-32 APD, 130 kHz, vertical component, 1.0 kHz predetection bandwidth, April 19, 1973, 12:00 p.m., Farley Headpiece, Itmann #3.

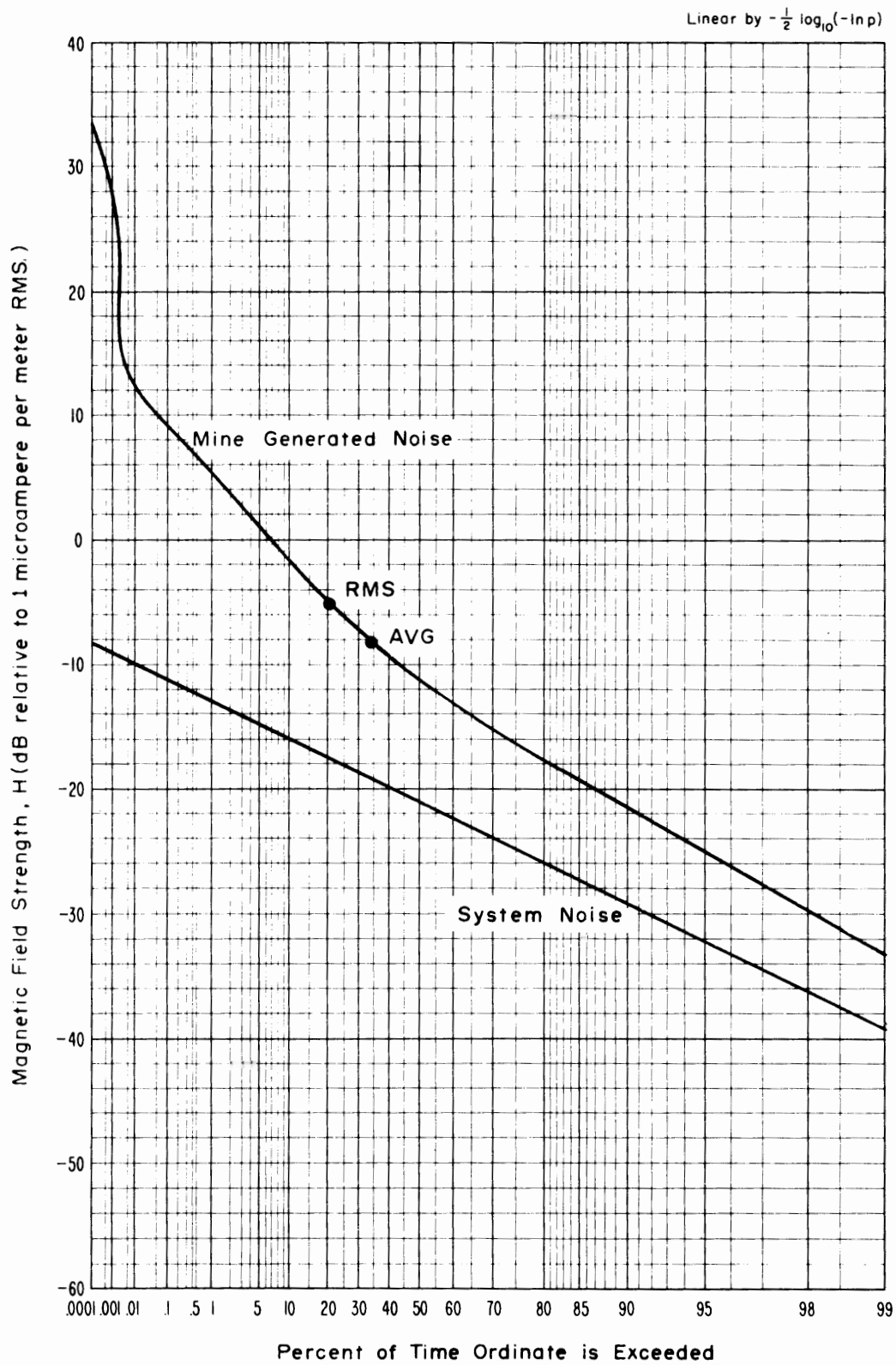

Figure 4-33 APD, 160 kHz, vertical component, 1.0 kHz predetection bandwidth, April 19, 1973, 12:30 p.m., Farley Headpiece, Itmann #3.

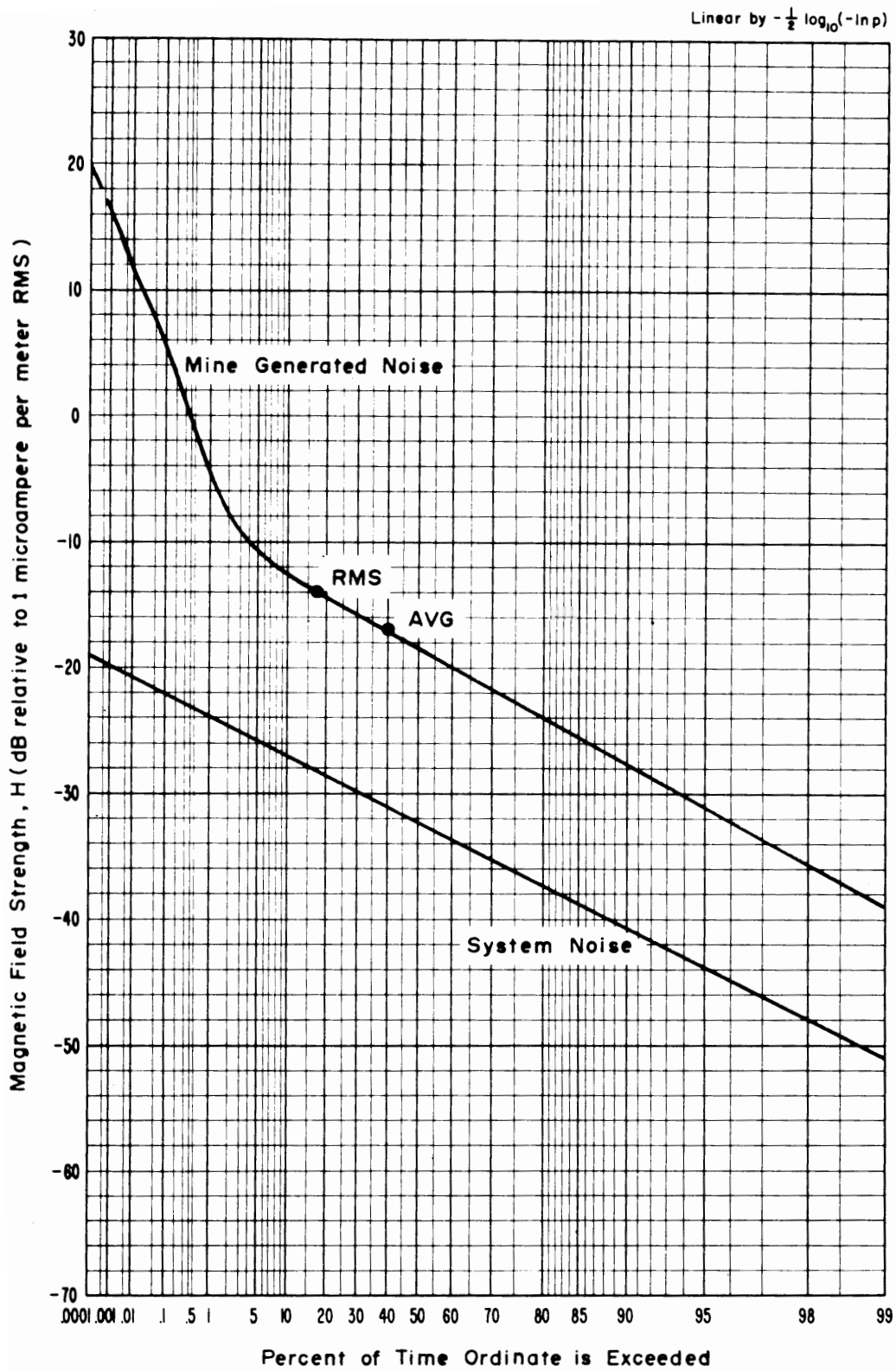

Figure 4-34 APD, 250 kHz, vertical component, 1.0 kHz predetection bandwidth, April 19, 1973, 1:00 p.m., Farley Headpiece, Itmann #3.

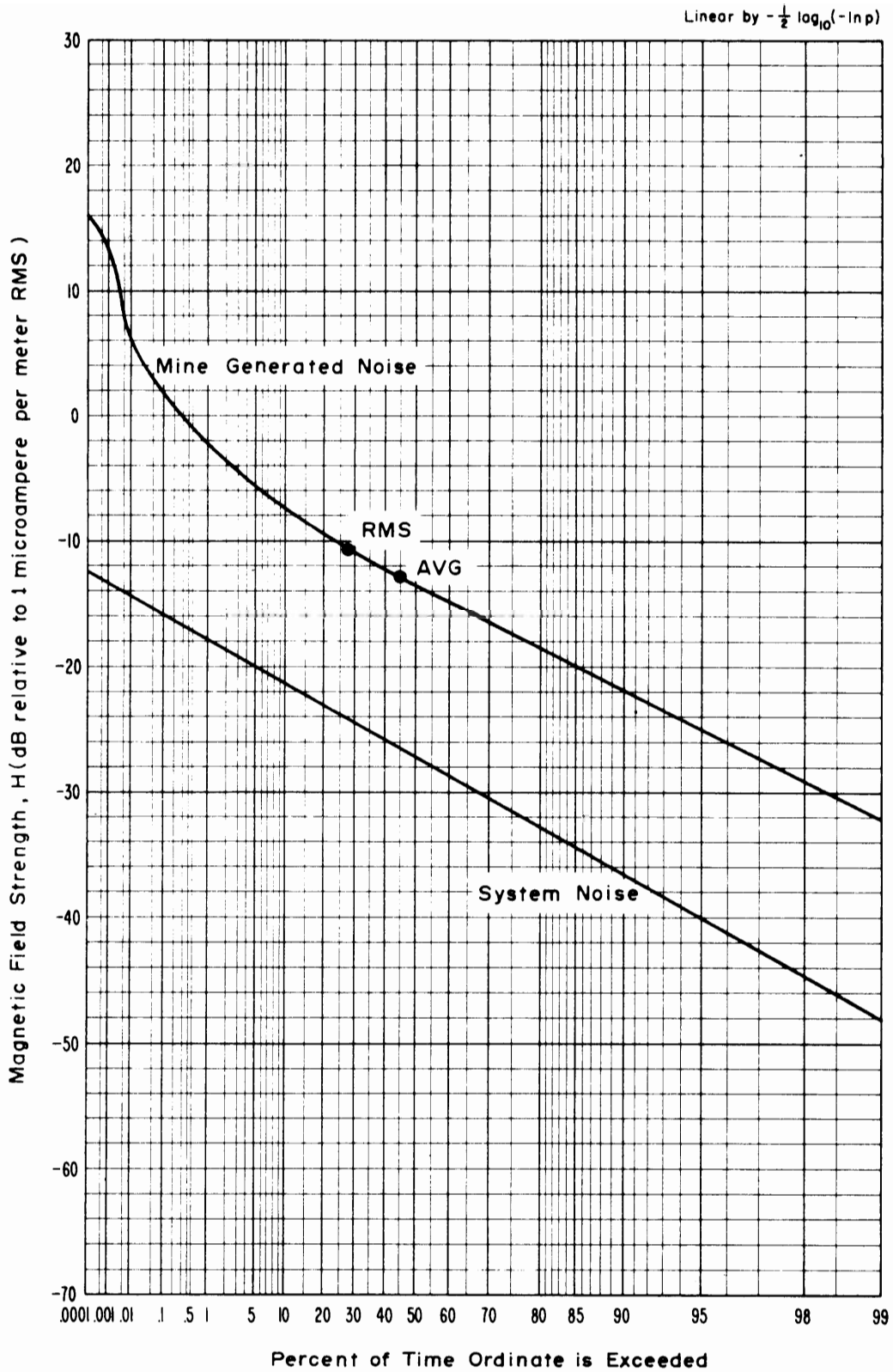

Figure 4-35 APD, 500 kHz, vertical component, 1.2 kHz predetection bandwidth, April 19, 1973, 10:20 a.m., Farley Headpiece, Itmann #3.

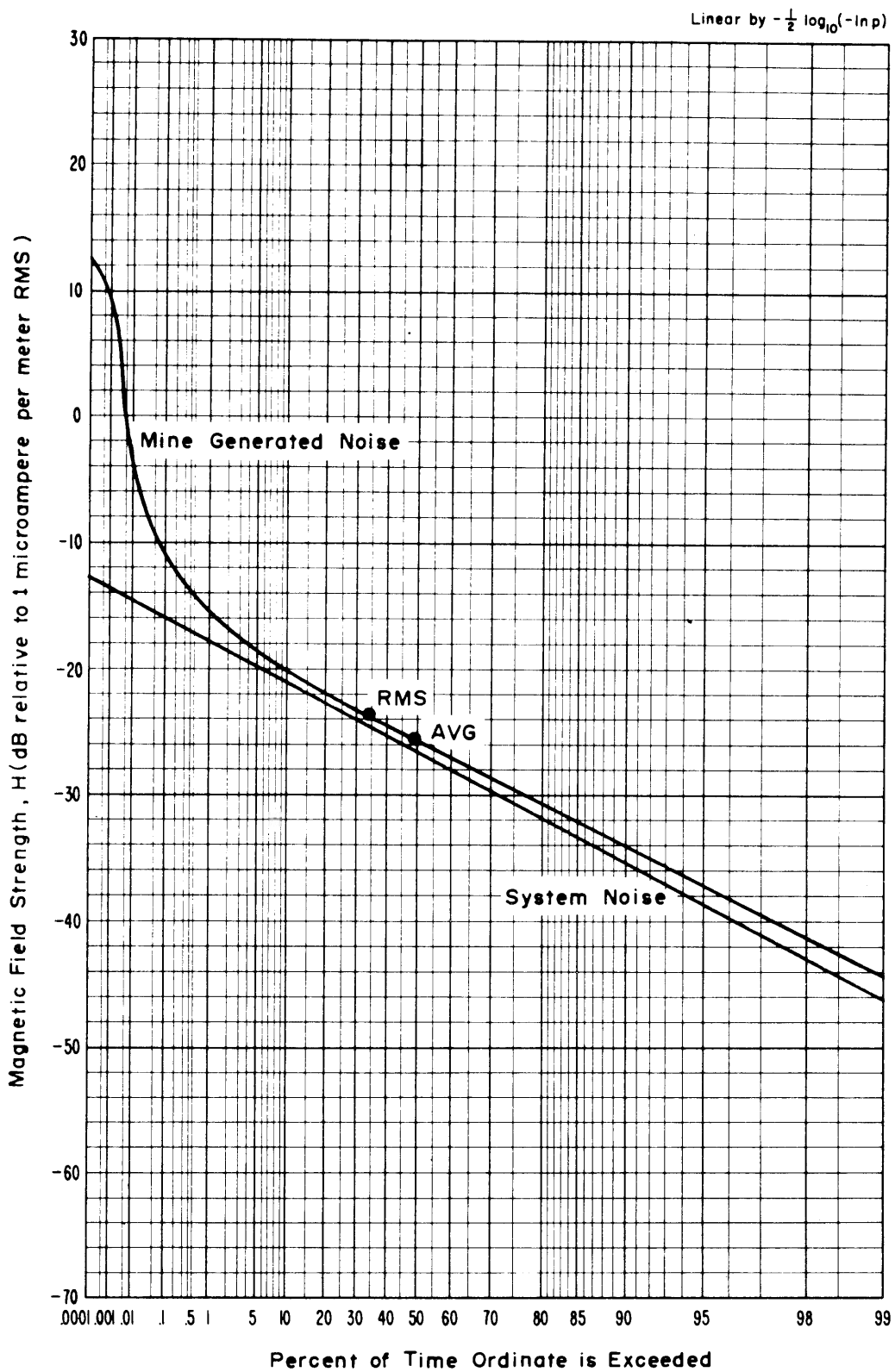

Figure 4-36 APD, 1 MHz, vertical component, 1.2 kHz predetection bandwidth, April 19, 1973, 10:50 a.m., Farley Headpiece, Itmann #3.

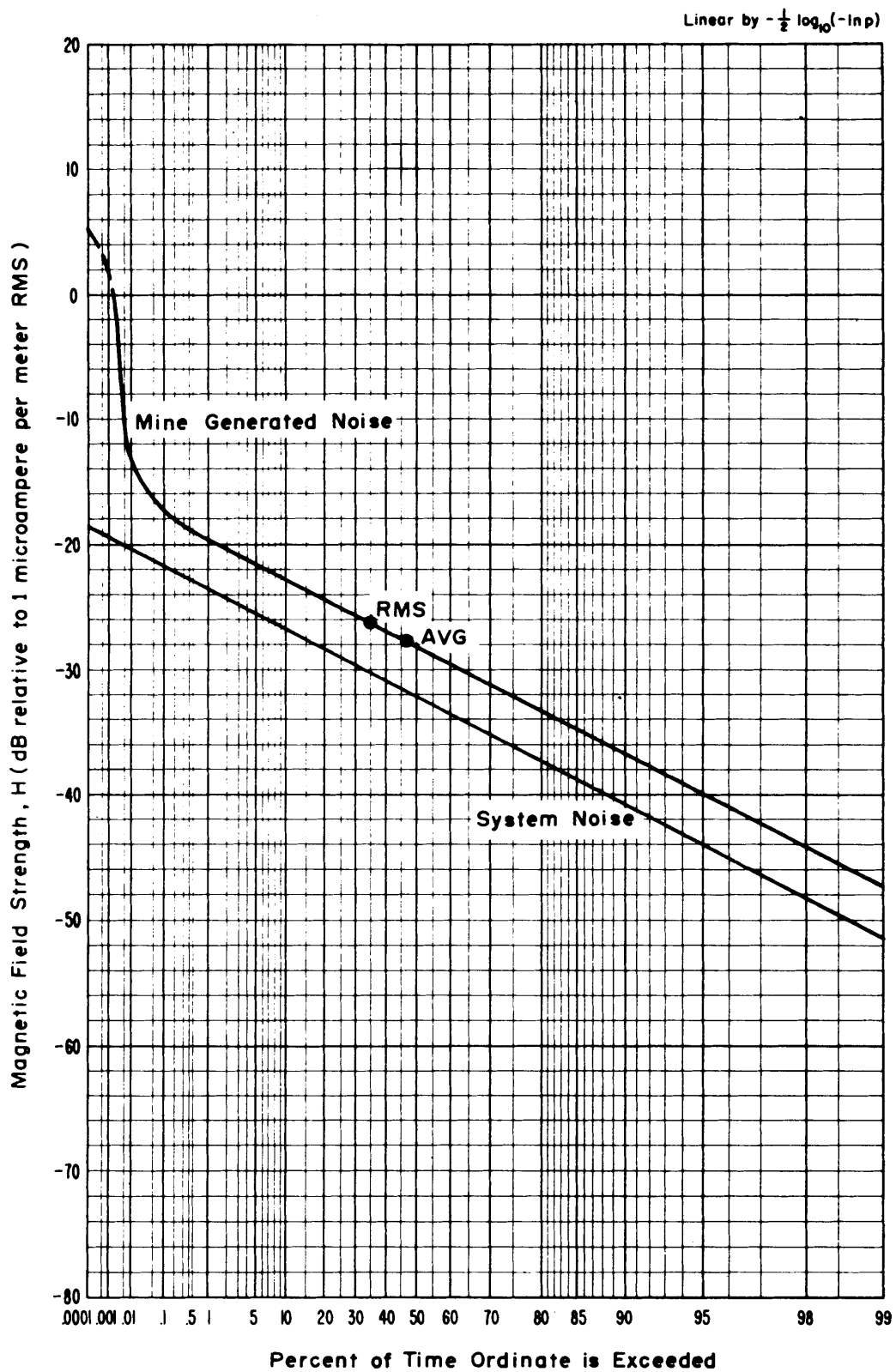

Figure 4-37 APD, 2 MHz, vertical component, 1.2 kHz predetection bandwidth, April 19, 1973, 11:25 a.m., Farley Headpiece, Itmann #3.

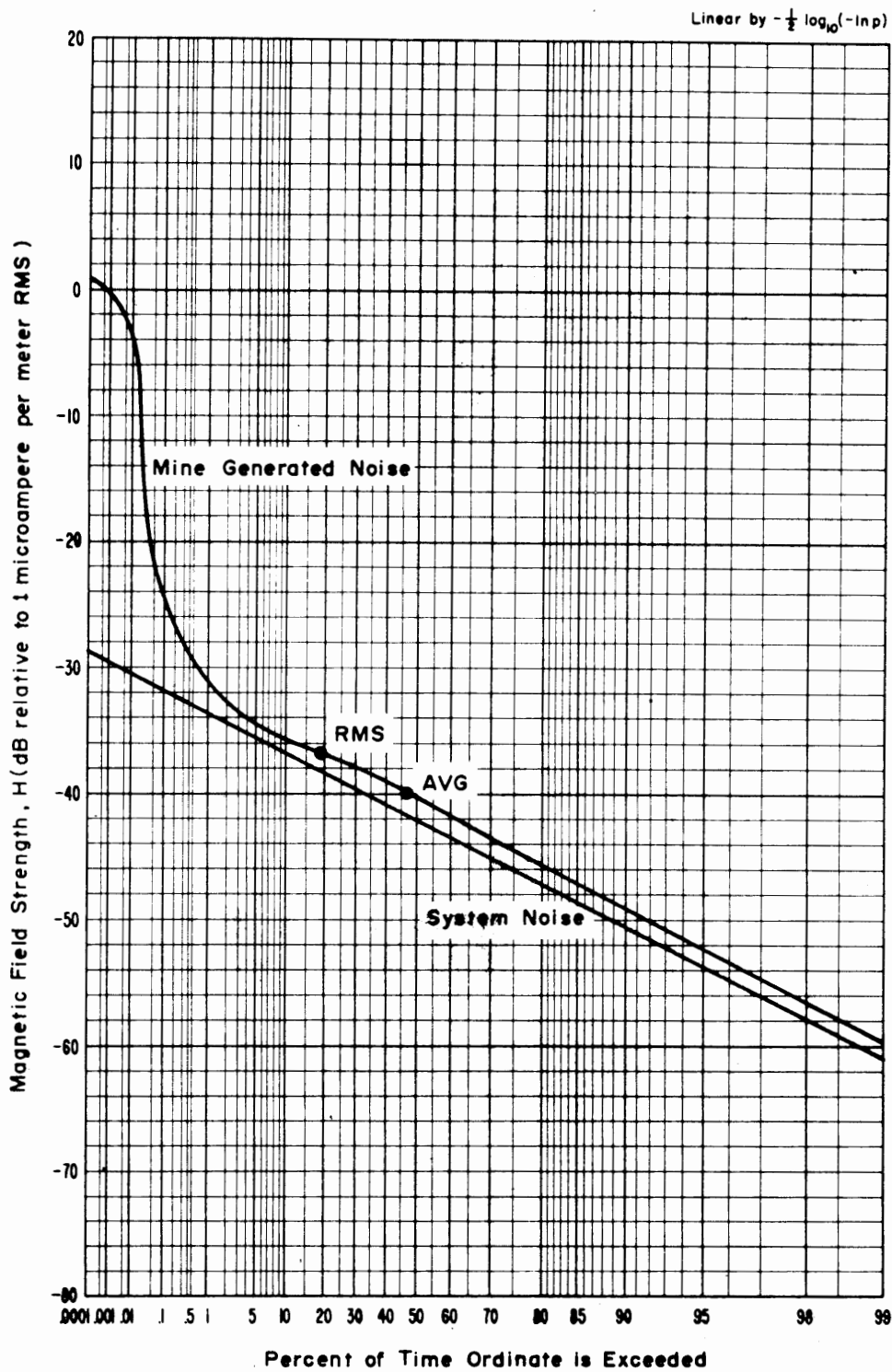

Figure 4-38 APD, 6 MHz, vertical component, 1.2 kHz predetection bandwidth, April 19, 1973, 12:00 p.m., Farley Headpiece, Itmann #3.

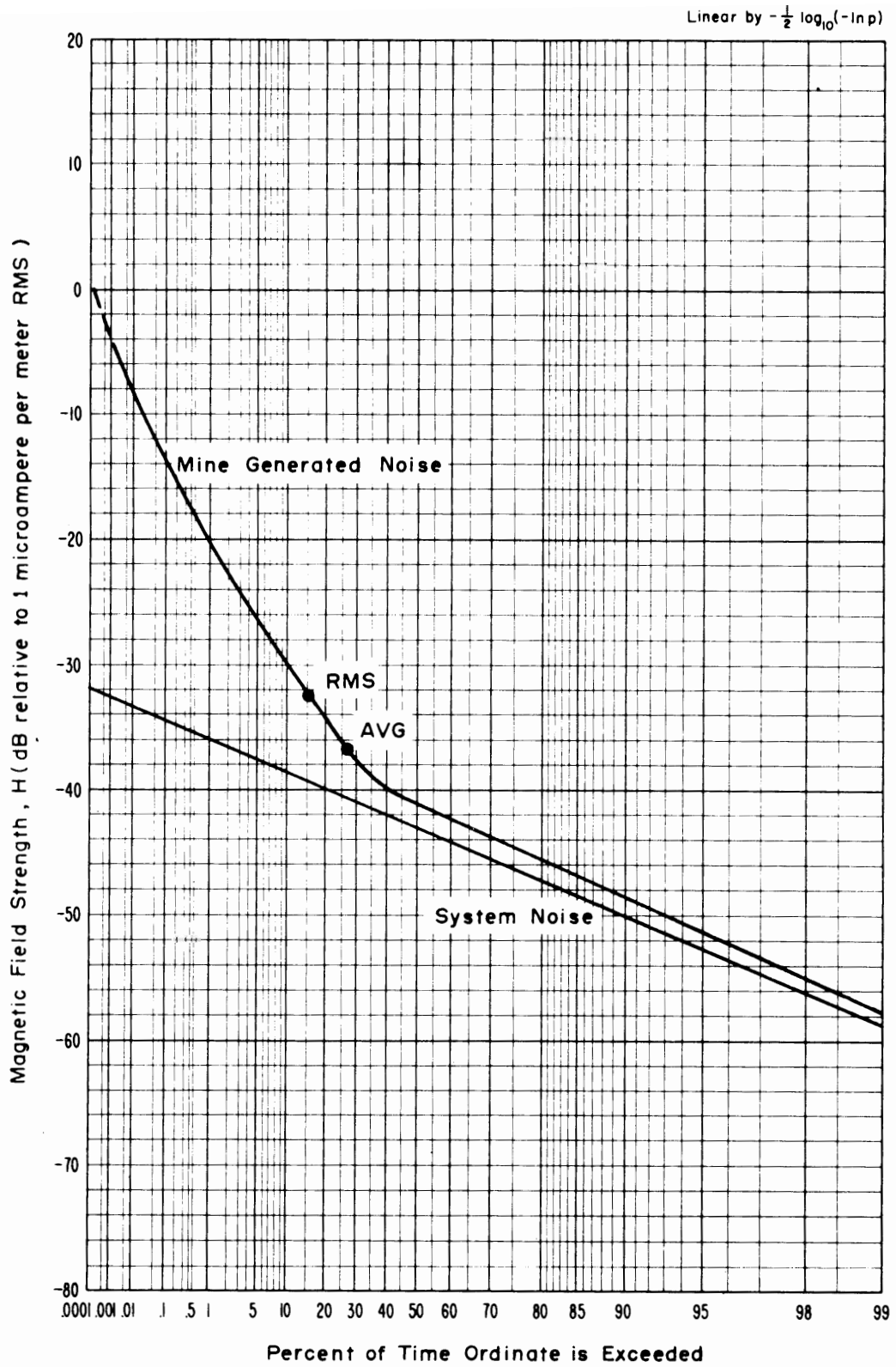

Figure 4-39 APD, 14 MHz, vertical component, 1.2 kHz predetection bandwidth, April 19, 1973, 12:30 p.m., Farley Headpiece, Itmann #3.

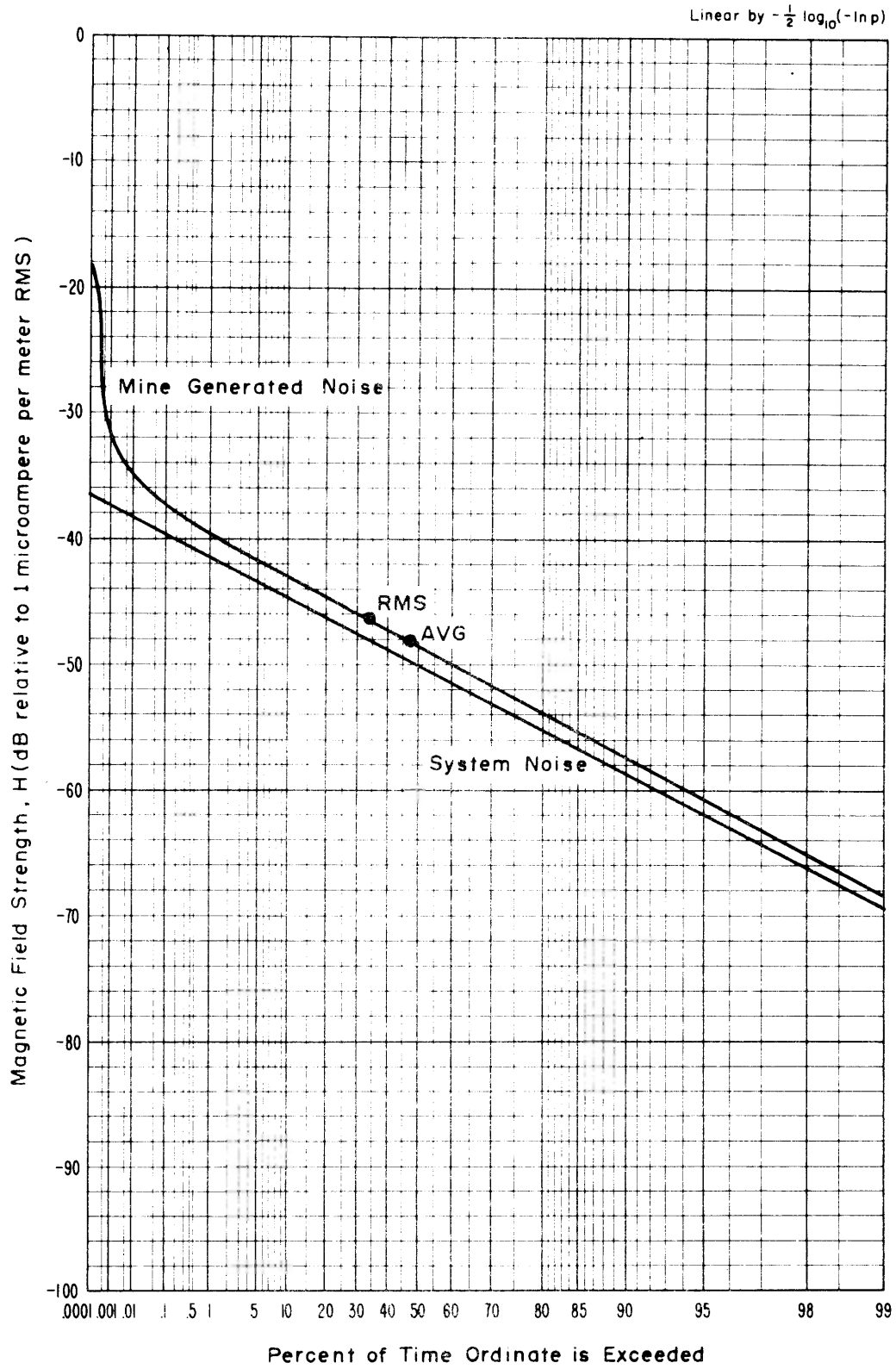

Figure 4-40 APD, 32 MHz, vertical component, 1.2 kHz predetection bandwidth, April 19, 1973, 1:00 p.m., Farley Headpiece, Itmann #3.

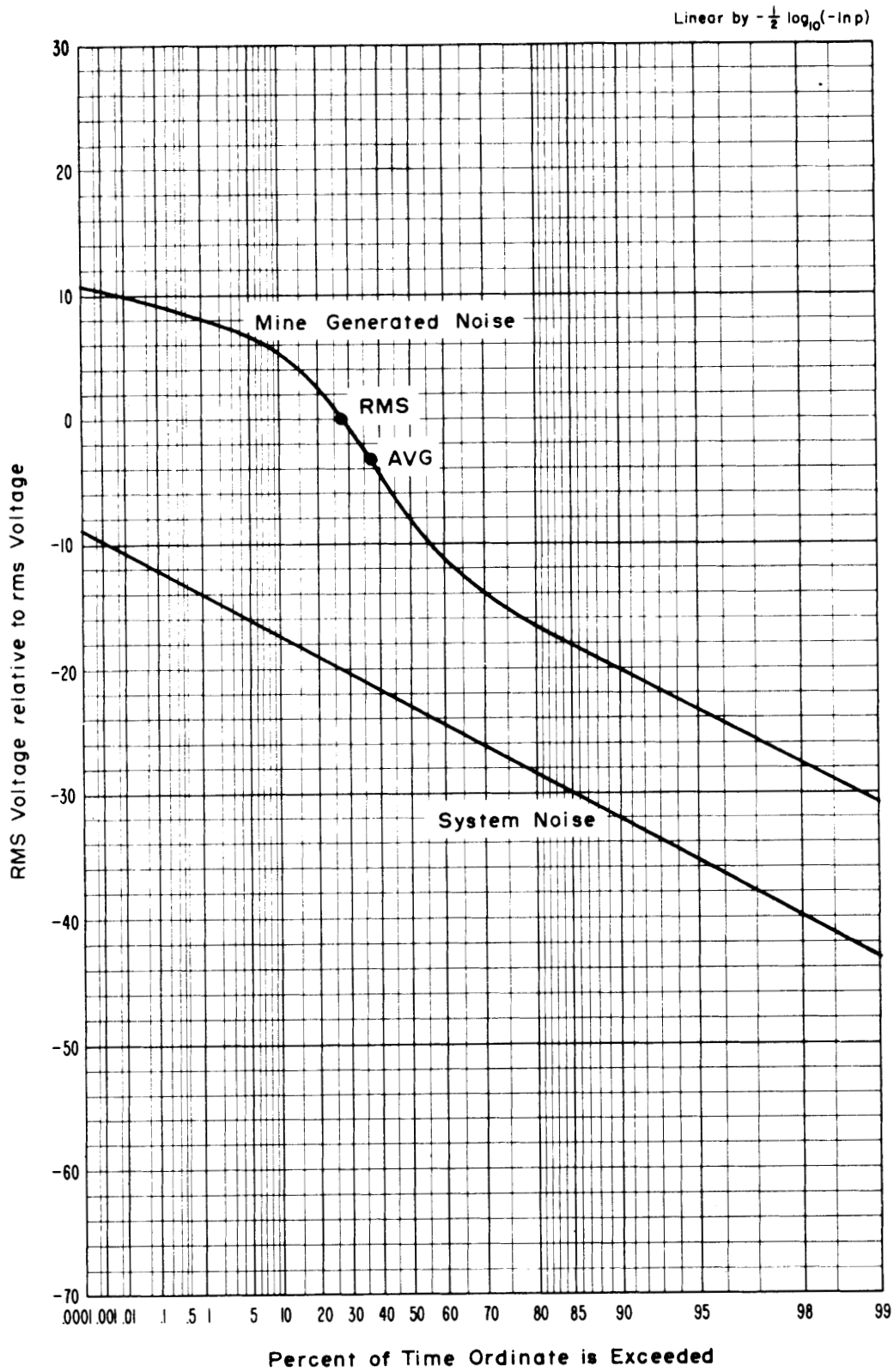

Figure 4-41 APD, 10 kHz, roof bolt measurement, 1.0 kHz predetection bandwidth, April 19, 1973, 1:30 p.m., Farley Headpiece, Itmann #3.

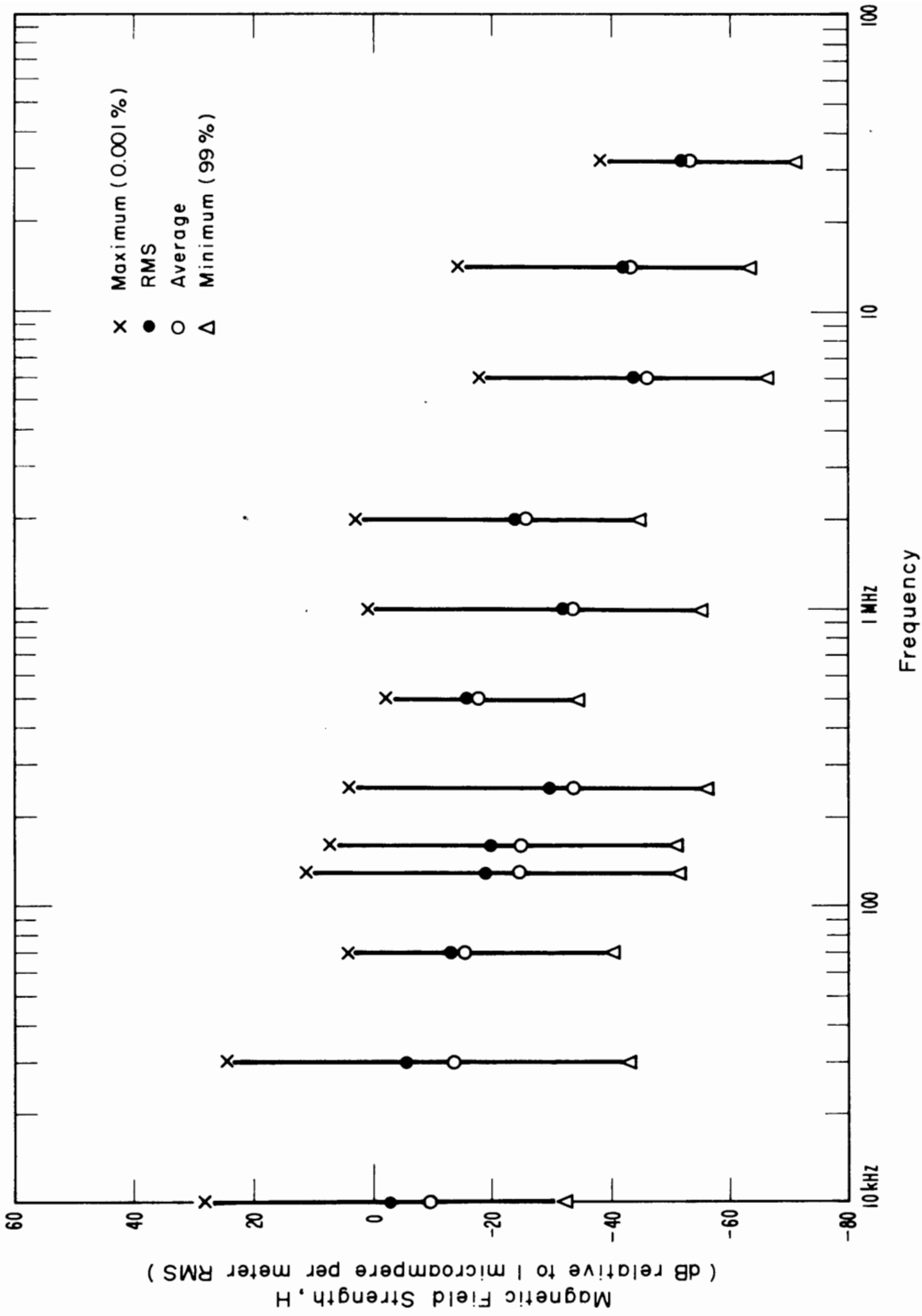

Figure 4-42 Field strength excursions between 0.001% and 99% of the time as a function of frequency, vertical component, Cabin Creek.

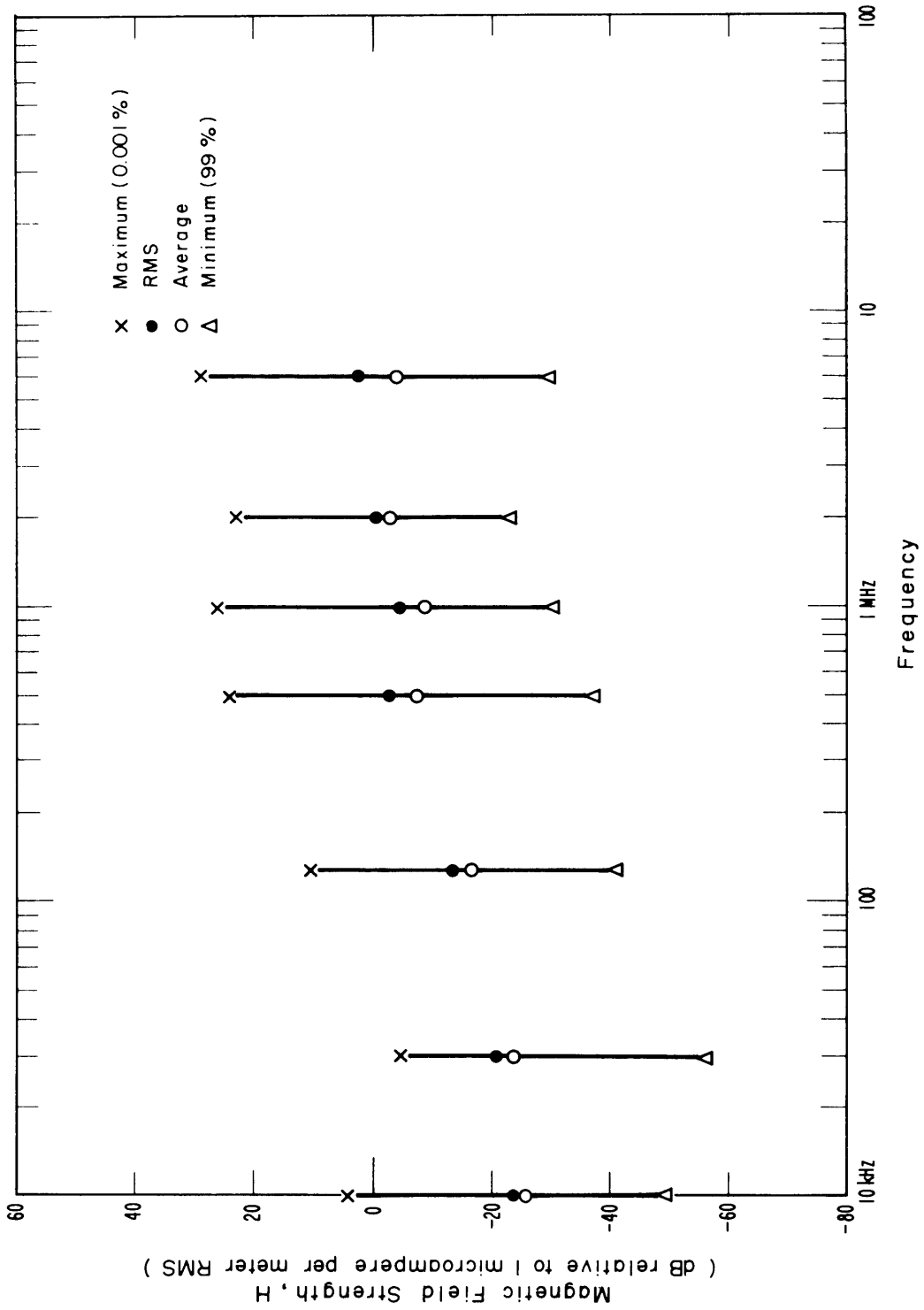

Figure 4-43 Field strength excursions between 0.001% and 99% of the time as a function of frequency, vertical component, quiet time, Cabin Creek.

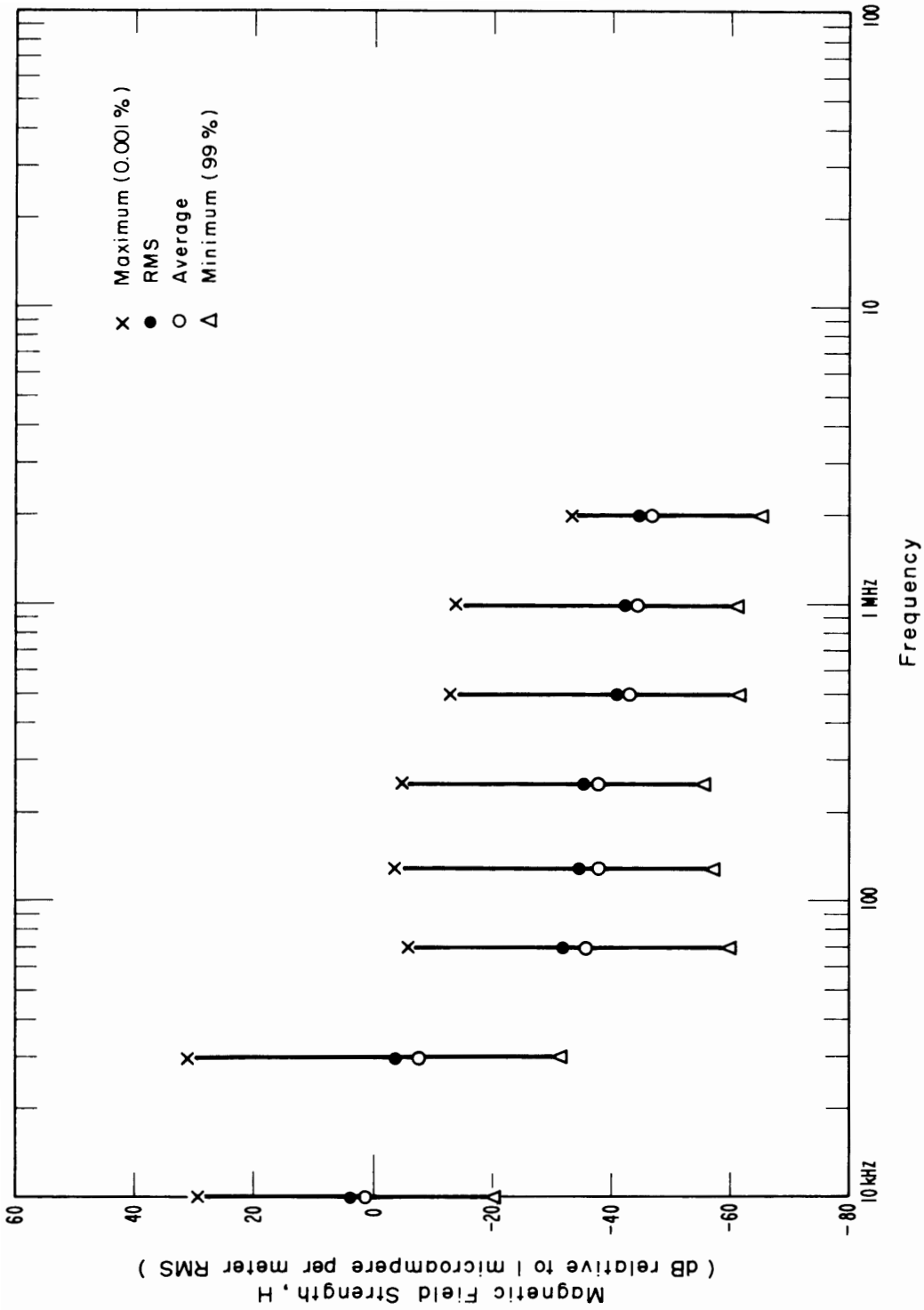

Figure 4-44 Field strength excursions between 0.001% and 99% of the time as a function of frequency, vertical component, Farley panel, April 17, 1973.

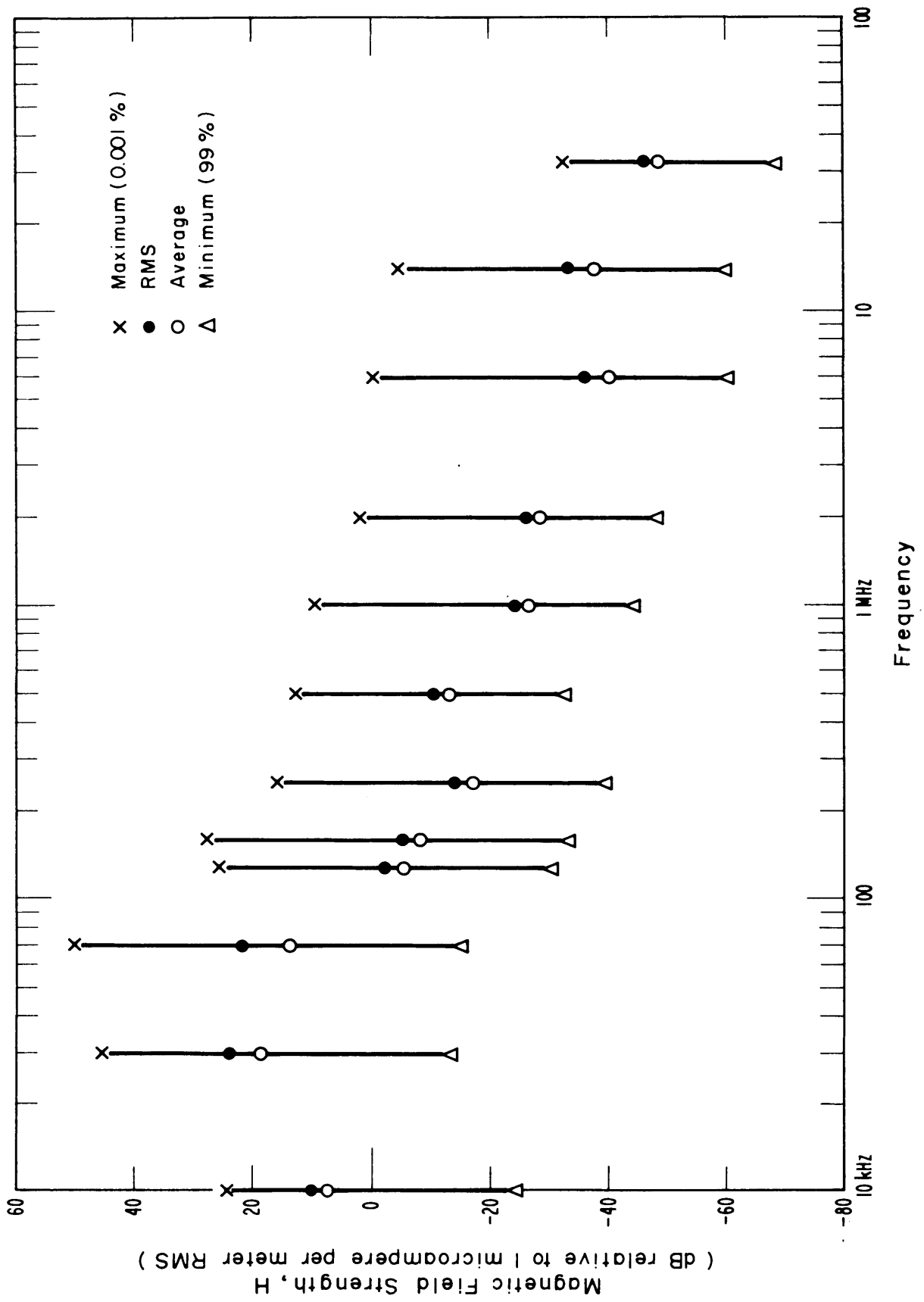

Figure 4-45 Field strength excursions between 0.001% and 99% of the time as a function of frequency, vertical component, Farley panel1, April 19, 1975.

5. CONCLUSIONS

In Itmann, we found that the haulageways usually had higher EM noise levels than exist near the face area. This was different from other mines; usually the face equipment is the prime source of noise. At higher frequencies, above 100 kHz, Itmann was noisier than other mines. So called "quiet" periods have low noise levels only at low frequencies, and only at considerable distances from rail haulageways.

The 88 kHz trolley phones in Itmann No. 3 may not have worse harmonic output than exists in other mines, but relatively high levels of harmonic signals were observed to 8 MHz in this mine on a spectrum analyzer. This was not true in one other mine, Grace Mine, but this measurement was not made in most mines visited.

There were also carriers present on an intermittent basis at frequencies other than the 88 kHz of the trolley phone. A strong one was at 202 kHz. In general dc machinery is noisier than ac machinery.

6. RECOMMENDATIONS

In Itmann, in addition to the lower than usual power-line-harmonic noise and the average impulsive noise, there are more intermittent cw carriers and harmonics of these carriers than in any other mine visited. Therefore, longer intervals of interference may be present at more discrete frequencies, and design of communication equipment should take this into account.

7. ACKNOWLEDGMENTS

Those making significant contributions to this program are as follows: laboratory development and field use of measurement equipment, Ed Neisen, Doug Schulze, and Tom Bremer; data processing, Anne Rumpfelt, Nancy Tomoeda, Winston Scott, Frank Cowley, and David Stearns. Those making valuable but less time-consuming contributions were Gerry Reeve, Bob Matheson, Don Spaulding, John Chukoski, Lorne Matheson, Dave Lewis, and Sharon Foote.

Winston Scott provided much assistance in proofreading, while Sharon Foote and Janet Becker typed tirelessly through many versions. Jocelyn Spencer and Barbara Bolton provided drafting assistance.

Finally, none of this would have been possible without the excellent cooperation of John Burr of Lee Engineering Company and of Bill Starling, Wes McDonald, John Henry Johnson, Hamp Clark, Thurman Tilley, and Jack Holt of Consolidation Coal Company.

8. REFERENCES

- [1] Bensema, W.D., Kanda, M., Adams, J.W., Electromagnetic Noise in Robena No. 4 Coal Mine, NBS Tech. Note 654, April 1974.
- [2] Adams, J.W., Bensema, W.D., Kanda, M., Electromagnetic Noise in Grace Hardrock Mine, NBSIR 74-388, June 1974.
- [3] The Institute of Electrical and Electronic Engineers, Inc., IEEE Dictionary of Electrical and Electronic Terms, Std. 100, 1972.
- [4] Taggart, H.E. and Workman, J.L., Calibration Principles and Procedures for Field Strength Meters (30 Hz to 1 GHz), NBS Tech. Note 370, March 1969.
- [5] Crichlow, W.Q., et al., Amplitude-probability distributions for atmospheric radio noise, NBS Monograph 23 (1960b).
- [6] Thompson, W.I., III, Bibliography of ground vehicle communications and control. AKWIC index, Report No. DOT-TSC-UMTA-71-3, July 1971.
- [7] Kanda, Motohisa, Adams, J.W., Bensema, W.D., Electromagnetic Noise in McElroy Coal Mine, NBSIR 74-389.
- [8] Spaulding, A.D., and Disney, R.T., Man-Made Radio Noise, Part I: Estimates for Business, Residential, and Rural Areas, OT Report 74-38, June 1974.

9. APPENDIX
Decoding of Spectrum Captions

Spectrum captions are generally organized into the following format:

First line: MP NDT NZS NDA NPO RC DF date, time, frame, serial, where

- MP = Two's power of length of Fourier transform, example, 2^{MP} where MP = 12
- NDT = Detrending option, example, 0 (dc removed)
- NZS = Restart spectral average after output, example, 0 (restarted)
- NDA = Data segment advance increment, example, 2048
- NPO = Number of spectra averaged between output calls, example, 20
- RC = Integration time in seconds per spectra, example, 0.168
- DF = Resolution bandwidth, spectral estimate spacing in hertz, example, 62.5
- Date = Date of computer processing, example, 03/21/73
- Time = Time of computer processing, example, 15:06:34
- Frame = Frame set number, example, 10
- Serial = Film frame serial number, example, 42.

Second line: DTA DA(1) DA(2) DA(3) NSA NRP NPP, where

- DTA = Detrending filter parameter α , example, 0.00195
- DA(1) = Detrending filter average, K=1, example, 59.4
- DA(2) = Detrending filter average, K=2, example, 0
- DA(3) = Detrending filter average, K=3, example, 0
- NSA = Number of periodograms averaged, example, 20
- NRP = Number of data points processed since spectrum initialization, example, 43008
- NPP = Number of data points processed since data initialization, example, 43008.

Third line: RUN, SESSION, DAY, MONTH, YEAR Gain corr., rec. =
tot. constr. =, where

Run and Session = the title of the portrayed frame identifying
the digitizing session and run number,
example, 21-83

Month, Day, Year = date data were recorded in the mine,
example, 8 25 73

Gain corr. rec. = receiver gain correction, example, 0

tot. const. = constant gain correction of entire system,
example, 46.4

Fourth line: C =, RG =, DG =, FG =, AG =, where

C = correction curve used with data, example, 25

RG = receiver gain and accompanying correction in dB added to
the data, example, 200 (-6 dB)

DG = digitizer gain, example, 0

FG = filter gain in dB, often rounded to nearest single digit,
example, 0

AG = absolute gain correction added to data, example, 52

Fifth line: Top of Scale, Standard Error, Spectral Peak, where

Top of Scale = largest scale marking for computer drawn
graph, example, 1.000+004 (1.0×10^4)

Standard Error = standard error of curve, example, 0.3162

Spectral Peak = largest spectral peak observed, example,
4.108+003 (4.108×10^3)

U.S. DEPT. OF COMM. BIBLIOGRAPHIC DATA SHEET		1. PUBLICATION OR REPORT NO. NBSIR 74-390	2. Gov't Accession No.	3. Recipient's Accession No.
4. TITLE AND SUBTITLE Electromagnetic Noise in Itmann Mine			5. Publication Date June 1974	
			6. Performing Organization Code	
7. AUTHOR(S) William D. Bensema, Motohisa Kanda, and John W. Adams			8. Performing Organ. Report No.	
9. PERFORMING ORGANIZATION NAME AND ADDRESS NATIONAL BUREAU OF STANDARDS, Boulder Labs DEPARTMENT OF COMMERCE Washington, D.C. 20234			10. Project/Task/Work Unit No. 2768412	
			11. Contract/Grant No.	
12. Sponsoring Organization Name and Complete Address (Street, City, State, ZIP) U. S. Bureau of Mines Pittsburgh Mining & Safety Research Center 4800 Forbes Avenue Pittsburgh, Pennsylvania 15213			13. Type of Report & Period Covered Report to Sponsor	
			14. Sponsoring Agency Code	
15. SUPPLEMENTARY NOTES				
16. ABSTRACT (A 200-word or less factual summary of most significant information. If document includes a significant bibliography or literature survey, mention it here.) Two different techniques were used to make measurements of the absolute value of electromagnetic noise in an operating coal mine, Itmann No. 3 Mine, located near Mullens, West Virginia. The electromagnetic environment created by 250-volt-dc and 550- and 950-volt-ac machinery in two longwall panels was measured and is reported. One technique measures noise over the entire electromagnetic spectrum of interest for brief time periods. It is recorded using broadband analog magnetic tape, and the noise data is later transformed to give spectral plots. The other technique records noise amplitudes at several discrete frequencies for a sufficient amount of time to provide amplitude probability distributions. The specific, measured results are given in a number of spectral plots and amplitude probability distribution plots.				
17. KEY WORDS (six to twelve entries; alphabetical order; capitalize only the first letter of the first key word unless a proper name; separated by semicolons) Amplitude probability distribution; coal mine noise, digital electromagnetic communications; electromagnetic interference; electromagnetic noise; Fast Fourier Transform; Gaussian distribution; impulsive noise; magnetic field strength; measurement instrumentation; spectral density; time-dependent spectral density.				
18. AVAILABILITY <input checked="" type="checkbox"/> Unlimited <input type="checkbox"/> For Official Distribution. Do Not Release to NTIS <input type="checkbox"/> Order From Sup. of Doc., U.S. Government Printing Office Washington, D.C. 20402, SD Cat. No. C13 <input type="checkbox"/> Order From National Technical Information Service (NTIS) Springfield, Virginia 22151			19. SECURITY CLASS (THIS REPORT) UNCLASSIFIED	
			20. SECURITY CLASS (THIS PAGE) UNCLASSIFIED	
			21. NO. OF PAGES	
			22. Price	