

# Ladder Safety App User's Manual (iOS)

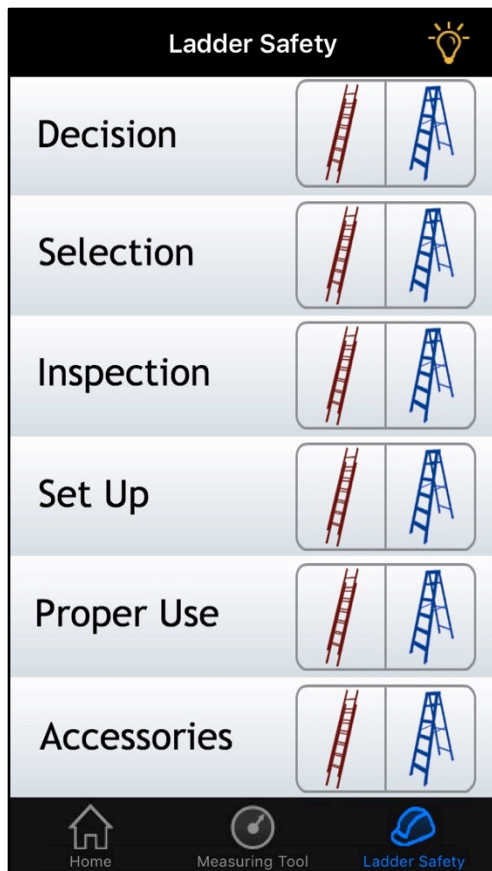

*National Institute for  
Occupational Safety and  
Health (NIOSH)*



**DSFederal**  
CONNECTING THE DOTS  
*Produced by DSFederal Inc.*

---

# Table of Contents

I. <a href="#">iOS App Installation</a>	3
II. <a href="#">Home Screen: Ladder Application</a>	4
A. <a href="#">Measuring Tool</a>	5
B. <a href="#">Ladder Safety</a>	8
a) <a href="#">1: Decision</a>	9
b) <a href="#">2: Selection</a>	11
c) <a href="#">3: Inspection</a>	19
d) <a href="#">4: Set Up</a>	23
e) <a href="#">5: Proper Use</a>	31
f) <a href="#">6: Accessories</a>	35
III. <a href="#">Accessibility Features</a>	39
IV. <a href="#">End-User License Agreement</a>	76

# iOS App Installation

## Instructions for loading the NIOSH Ladder Safety iOS App:\*

- Go to the [Apple iTunes Market](http://www.itunes.com/appstore), <<http://www.itunes.com/appstore>>, on your iPhone, iPod Touch or iPad
- Tap the Search icon (magnifying glass)
- Type 'Ladder Safety' in the search field
- Select the App by tapping the  Ladder Safety App icon
- Select INSTALL to download App to tablet or phone
- Once completely downloaded and installed, the App is ready to use
- Launch the Ladder Safety iOS App

*\*iOS 8.0 or higher is required for using the iOS App. To view and use the app in Spanish, select Spanish as the main language on your device.*

# Home Screen: Ladder Application



The light blub toggles between high-contrast mode and normal mode.

Refer to the [Accessibility Features](#) section for more information.

This button shows the disclaimer.

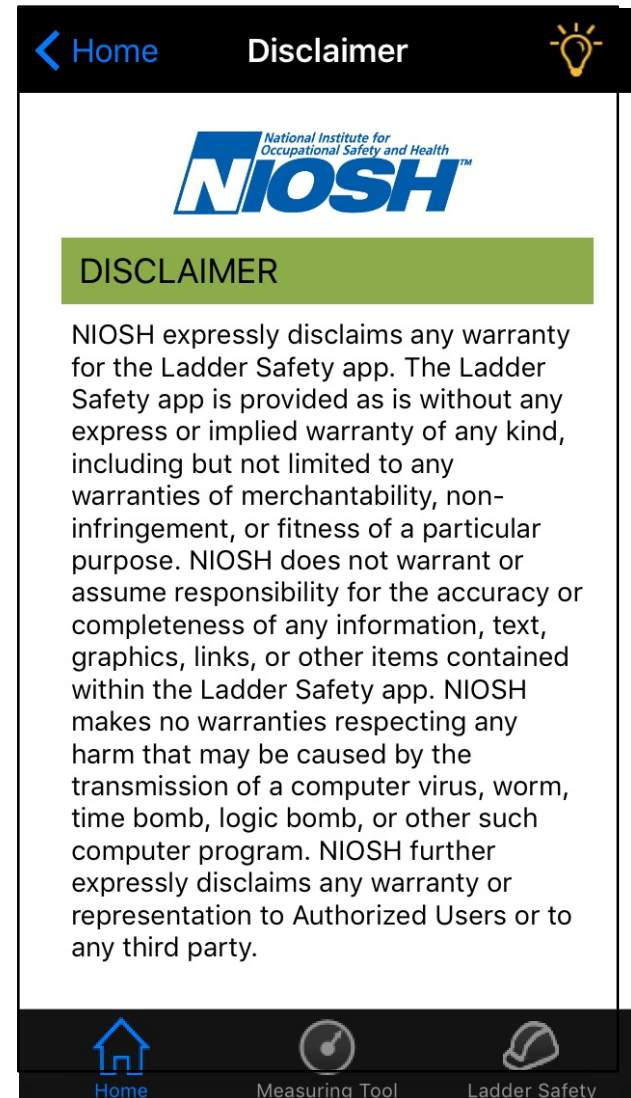

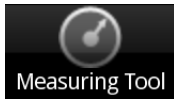

# Measuring Tool

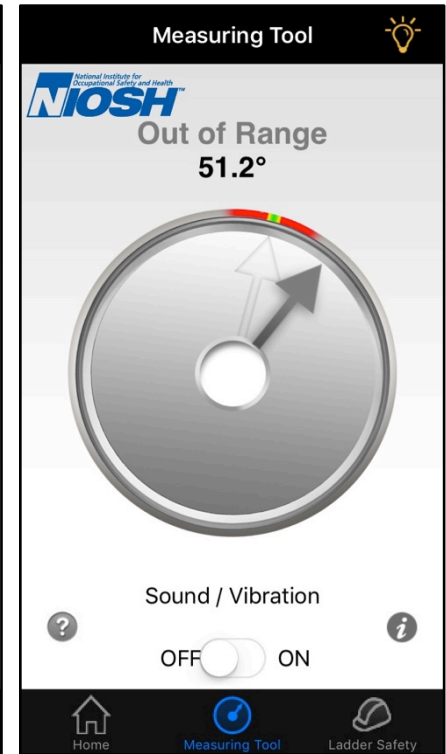
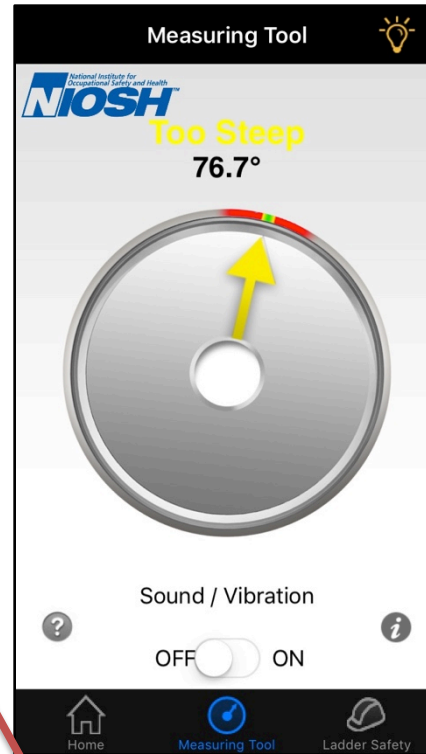
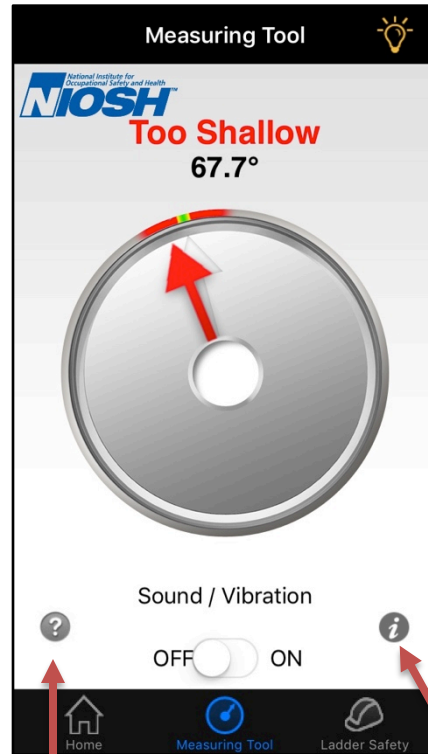
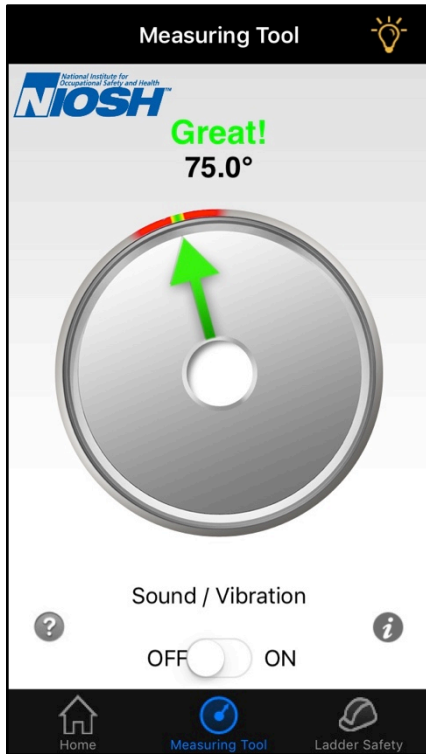

The help page will show after tapping this icon.

The home page will show after tapping this icon.

There will be a visual indication on the screen (red arrow) outside the range of  $\pm 1$  degrees from 75 degrees, indicating the ladder is not yet at the proper angle.

If the user has enabled vibration and sound, there will be an audible, constant tone, a vibration, and a visual indication (green arrow) on the screen in the range of  $\pm 1$  degrees from 75 degrees indicating a "great" type of notice.

# Measuring Tool: Verticality

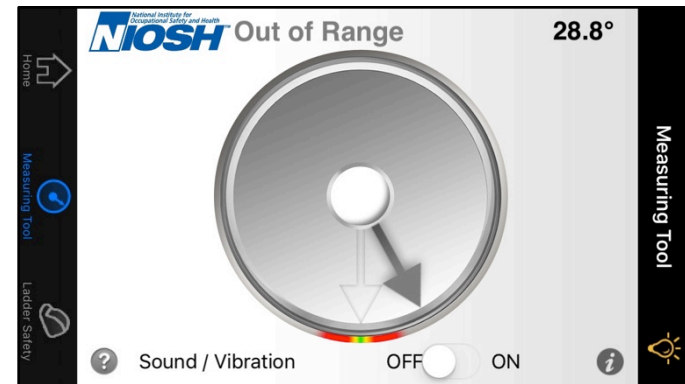
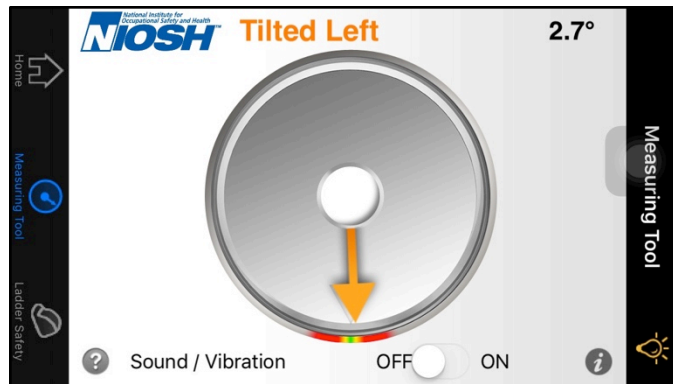
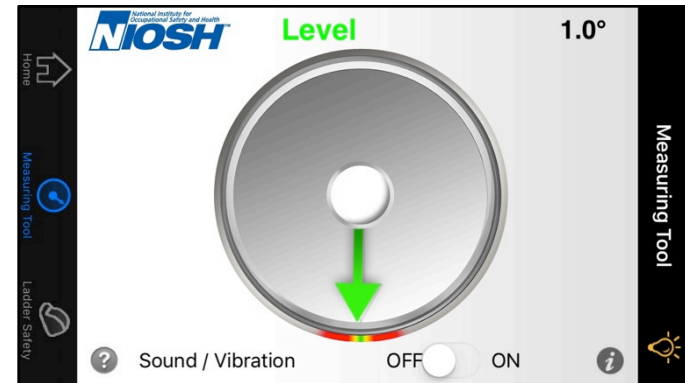
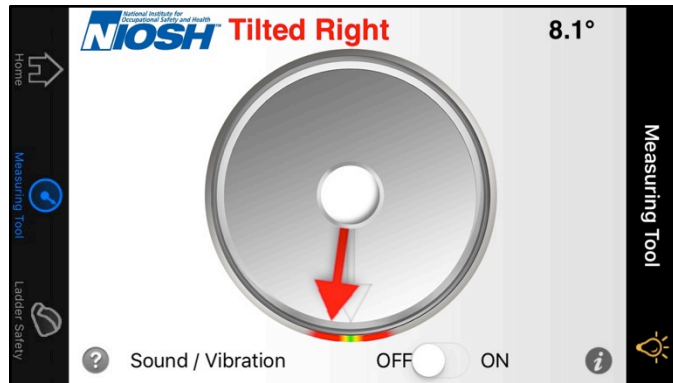

If the user tilts the device 90 degrees (landscape mode), verticality mode is enabled.

There will be a visual indication on the screen (red arrow) outside the range of  $\pm 1.5$  degrees from 0 degrees, indicating the ladder is not yet at the proper angle.

If the user has enabled vibration and sound, there will be an audible, constant tone, a vibration, and a visual indication (green arrow) on the screen in the range of  $\pm 1.5$  degrees from 0 degrees indicating a "level" type of notice.

# Measuring Tool

## Help

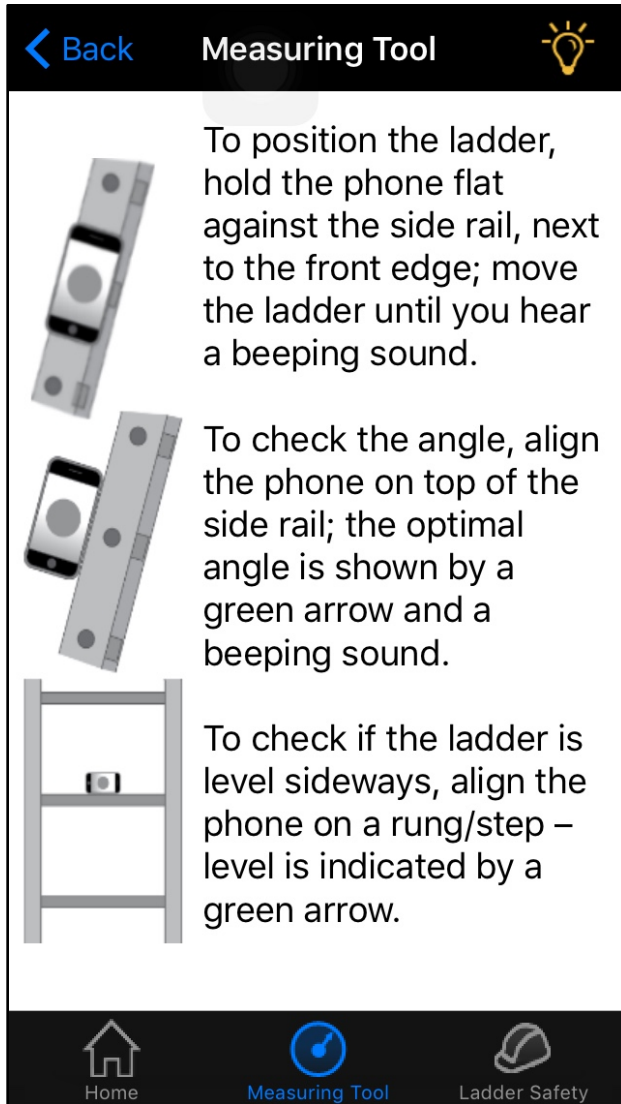

The screenshot shows the 'Measuring Tool' app interface. At the top, there is a 'Back' button with a left arrow and a 'Measuring Tool' title next to a lightbulb icon. The main content area contains three instructions, each with an illustration and a text block. The first instruction shows a phone on a ladder side rail. The second shows a phone on top of a side rail. The third shows a phone on a ladder rung. At the bottom, there is a navigation bar with three icons: a house for 'Home', a blue circle with a white arrow for 'Measuring Tool', and a hard hat for 'Ladder Safety'.

[← Back](#)   Measuring Tool   

 To position the ladder, hold the phone flat against the side rail, next to the front edge; move the ladder until you hear a beeping sound.

 To check the angle, align the phone on top of the side rail; the optimal angle is shown by a green arrow and a beeping sound.

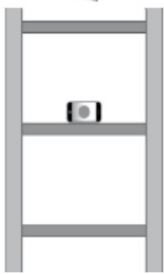
 To check if the ladder is level sideways, align the phone on a rung/step – level is indicated by a green arrow.

Home   Measuring Tool   Ladder Safety

The Measuring Tool **Help** button  opens [Setup Ladder Angle – Measuring Tool](#) page.



# Ladder Safety

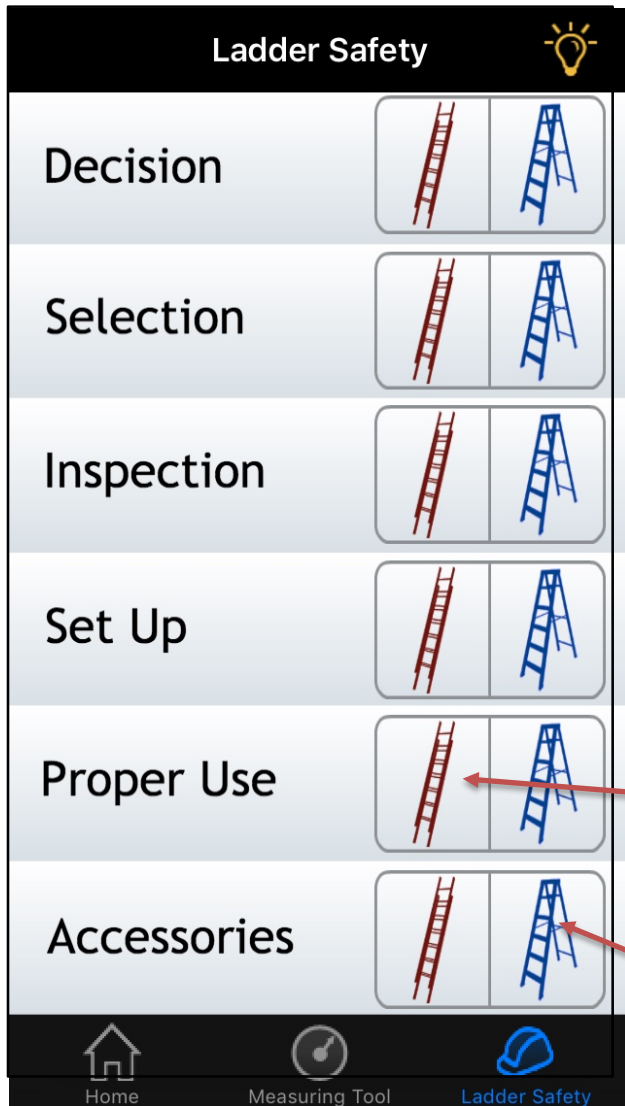

When the user taps the **Ladder Safety** button, a window will appear with options to go to the following screens:

- 1: Decision
- 2: Selection
- 3: Inspection
- 4: Set Up
- 5: Proper Use
- 6: Accessories

With the new unified menu, the user can select either the extension ladder or step ladder screens by touching the respective button.

Touch the extension ladder icon to go to the extension ladder version of the screen.

Ex) Touching the extension ladder on the Proper use row will lead to the Proper use for extension ladders.

Touch the step ladder icon to go to the step ladder version of the screen.

Ex) Touching the step ladder on the Accessories row will lead to the Accessories for step ladders



# 1: Extension Ladder-Decision

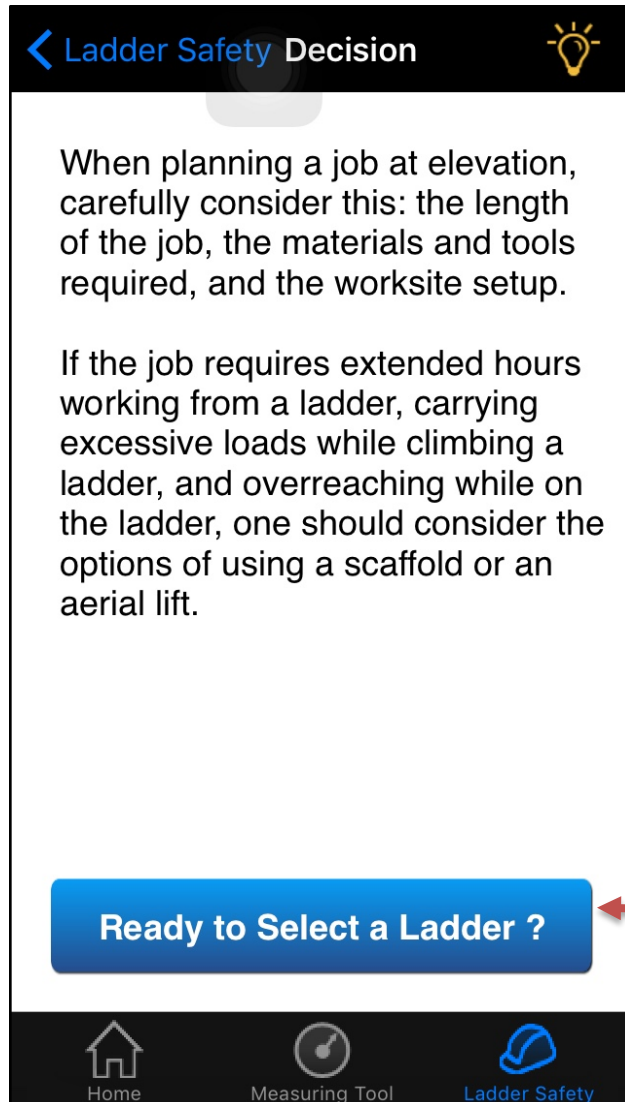

## Decision:

A series of suggestions will be presented:

- When planning a job at elevation, carefully consider:
  - The length of the job
  - The materials and tools required
  - The worksite setup
- Consider using a scaffold or an aerial lift if the job requires:
  - Extended hours working from a ladder
  - Carrying excessive loads while climbing a ladder
  - Overreaching while on the ladder

← The Selection screen appears after tapping this button.

# 1: Step Ladder-Decision

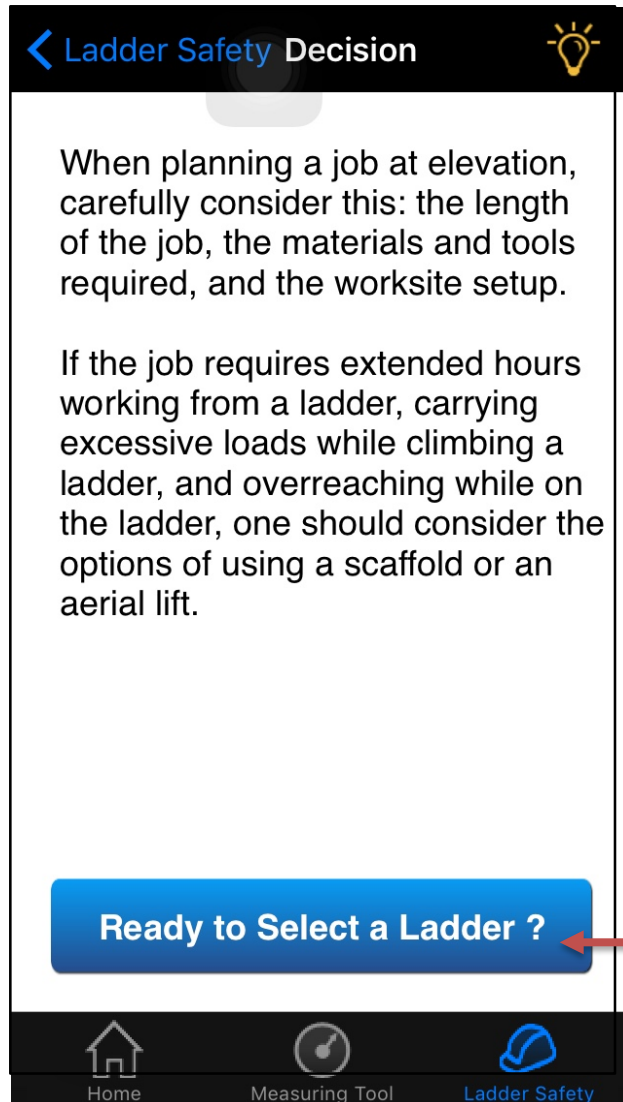

## Decision:

**\*This screen is identical to the Decision screen for the extension ladder, as the decisions are relevant to both extension and step ladders.**

A series of suggestions will be presented:

- When planning a job at elevation, carefully consider:
  - The length of the job
  - The materials and tools required
  - The worksite setup
- Consider using a scaffold or an aerial lift if the job requires:
  - Extended hours working from a ladder
  - Carrying excessive loads while climbing a ladder
  - Overreaching while on the ladder

The Selection screen appears after tapping this button.

# 2: Extension Ladder-Selection Home Screen

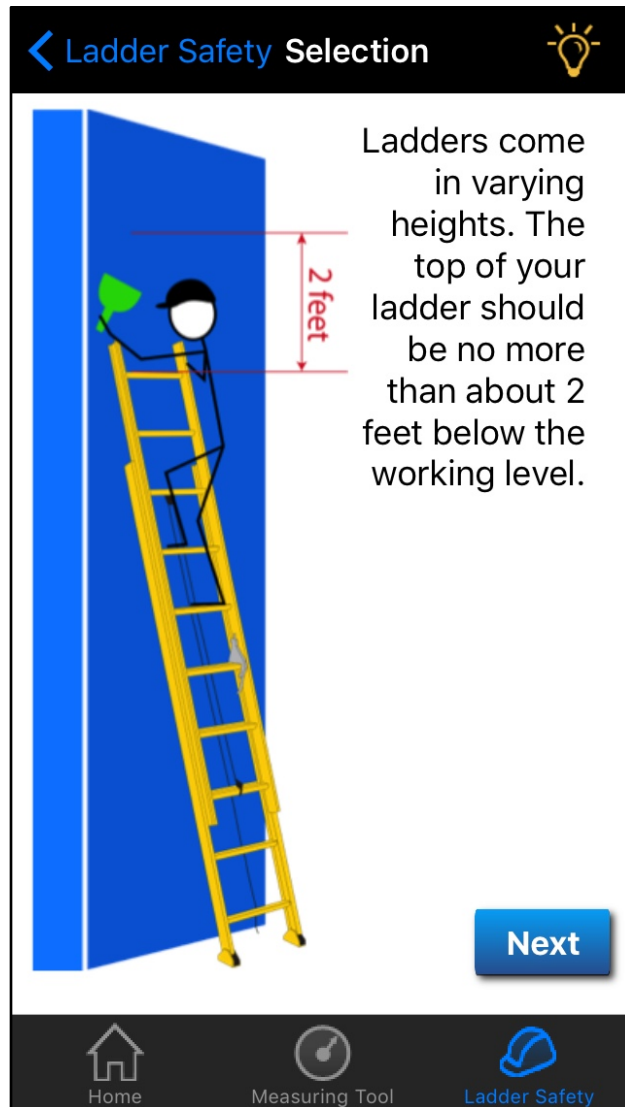

This home screen helps the user learn that the top of the extension ladder should be no more than 2 feet below the working level.

Pressing the Next button will lead to duty rating screen.

# 2: Extension Ladder-Selection Duty Rating

Selection Duty Rating

How much do you weigh, including tools and materials?

150 lbs

Will you or the ladder be near exposed electrical conductors?

YES NO

Show me the ladder

Home Measuring Tool Ladder Safety

## Questions

This button will open up a rolling graphics (like a slot machine) allowing the user to scroll through and select values for the weigh question

## Response

Depending on the data entered, a ladder will be recommended when the user taps the **Show me the ladder** button.

- Light Duty Type III  $\leq 200$  lbs
- Medium Duty Type II  $\leq 225$  lbs
- Heavy Duty Industrial Type I  $\leq 250$  lbs
- Extra Heavy Duty Industrial Type IA  $\leq 300$  lbs
- Special Duty Rugged Professional Type IAA  $\leq 375$  lbs

## Info

This button will open up a rolling window that shows the sample rating stickers.

Selection Duty Rating

How much do you weigh, including tools and materials?

190 lbs

Will you or the ladder be near exposed electrical conductors?

YES NO

Done

175 lbs

180 lbs

185 lbs

190 lbs

195 lbs

200 lbs

205 lbs

# 2: Extension Ladder-Selection

## Show Me The Ladder

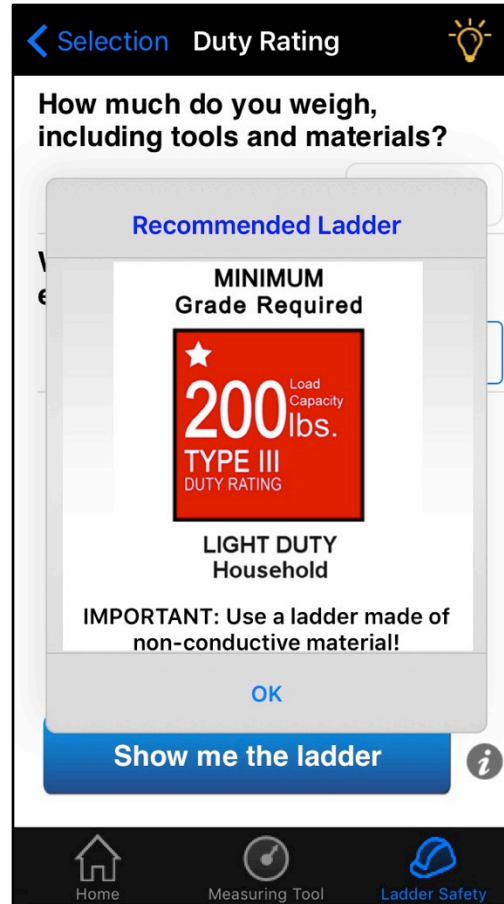
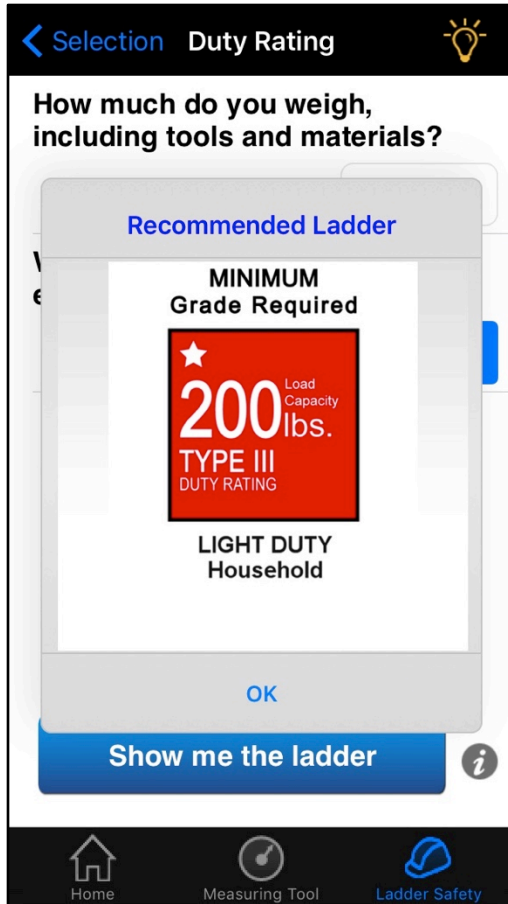

After tapping the **Show me the ladder** button, a pop up window with a written description of the ladder appears.

If an electrical hazard is present, the user will be advised to use a ladder made of non-conductive material.

The user may select new values and recalculate by tapping "Show me the ladder" again.

# 2: Extension Ladder-Selection

## Sample Rating Stickers

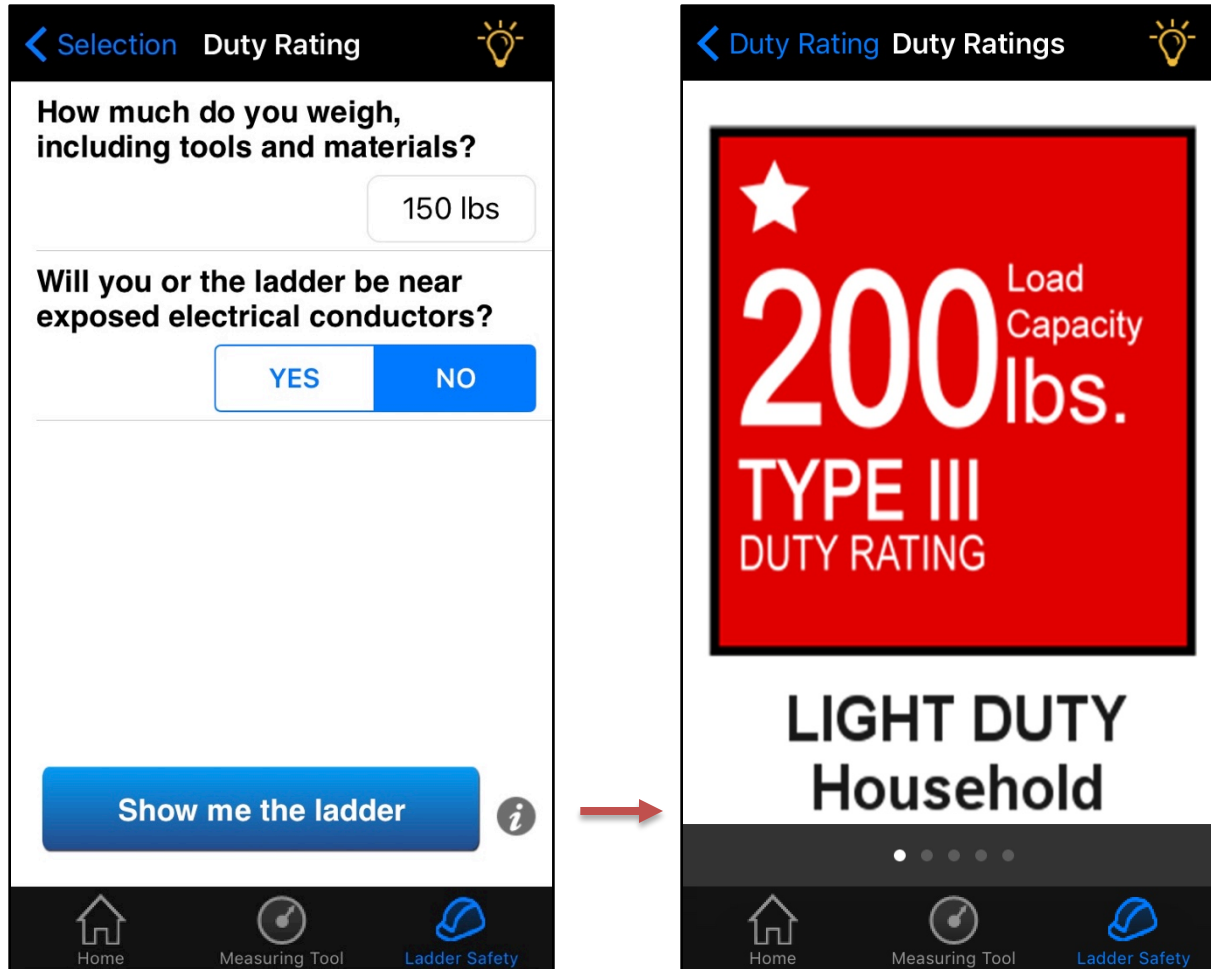

The **Info** button opens a rolling window that shows sample rating stickers.

## 2: Step Ladder-Selection Home Screen

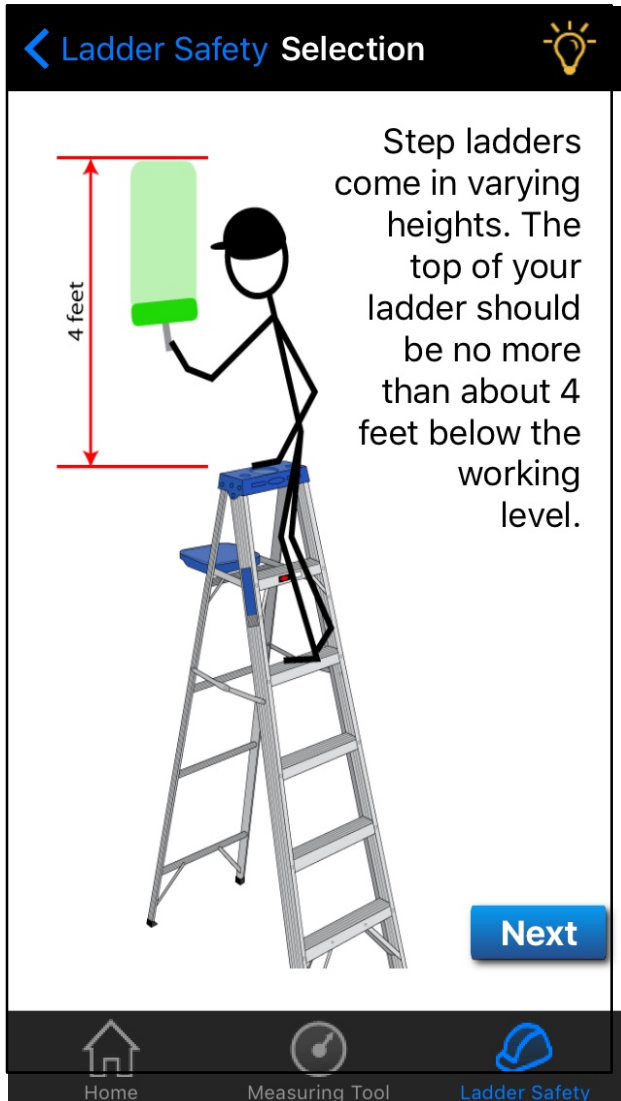

- This home screen helps the user learn that the top of the step ladder should be no more than 4 feet below the working level.

Pressing the Next button will lead to duty rating screen.



# 2: Step Ladder-Selection Duty Rating

Selection Duty Rating

How much do you weigh, including tools and materials?

150 lbs

Will you or the ladder be near exposed electrical conductors?

YES NO

Show me the ladder

Home Measuring Tool Ladder Safety

## Questions

This button will open up a rolling graphics (like a slot machine) allowing the user to scroll through and select values for the weigh question

## Response

Depending on the data entered, a ladder will be recommended when the user taps the **Show me the ladder** button.

- Light Duty Type III  $\leq 200$  lbs
- Medium Duty Type II  $\leq 225$  lbs
- Heavy Duty Industrial Type I  $\leq 250$  lbs
- Extra Heavy Duty Industrial Type IA  $\leq 300$  lbs
- Special Duty Rugged Professional Type IAA  $\leq 375$  lbs

## Info

This button will open up a rolling window that shows the sample rating stickers.

Selection Duty Rating

How much do you weigh, including tools and materials?

190 lbs

Will you or the ladder be near exposed electrical conductors?

YES NO

Done

175 lbs

180 lbs

185 lbs

190 lbs

195 lbs

200 lbs

205 lbs

\*This screen is identical to the Selection Duty Rating for extension ladders, as extension ladders and step ladders share the same duty ratings.



# 2: Step Ladder-Selection

## Show Me The Ladder

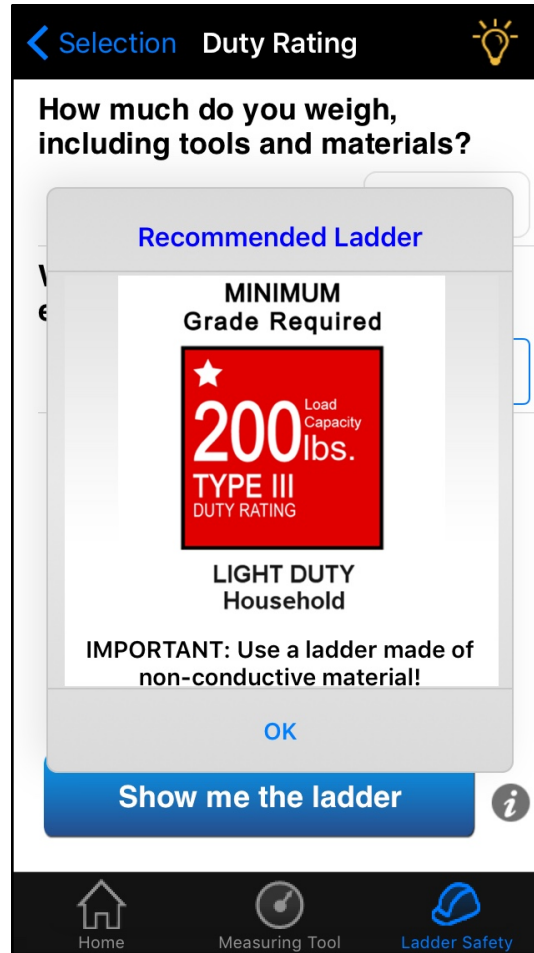
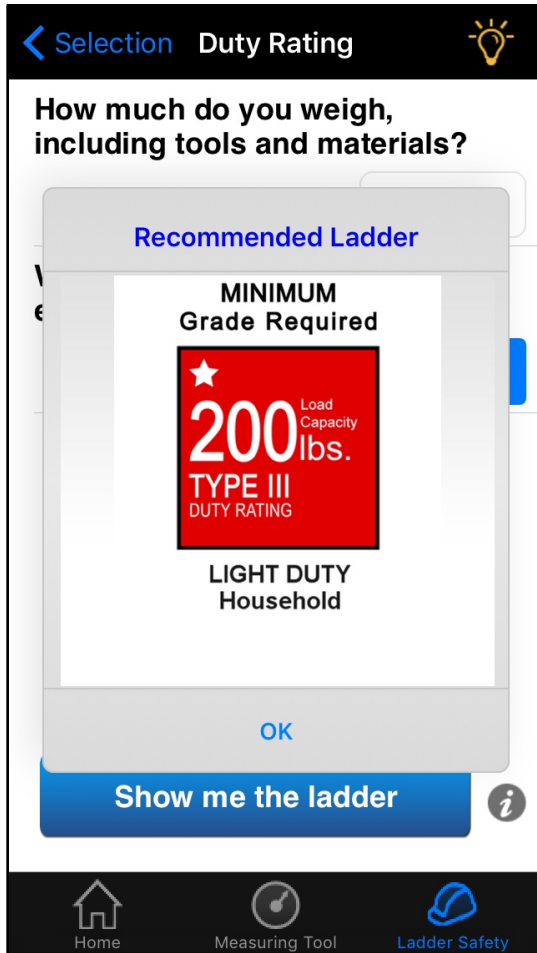

After tapping the **Show me the ladder** button, a pop up window with a written description of the ladder appears.

If an electrical hazard is present, the user will be advised to use a ladder made of non-conductive material.

The user may select new values and recalculate by tapping "Show me the ladder" again.

# 2: Step Ladder-Selection

## Sample Rating Stickers

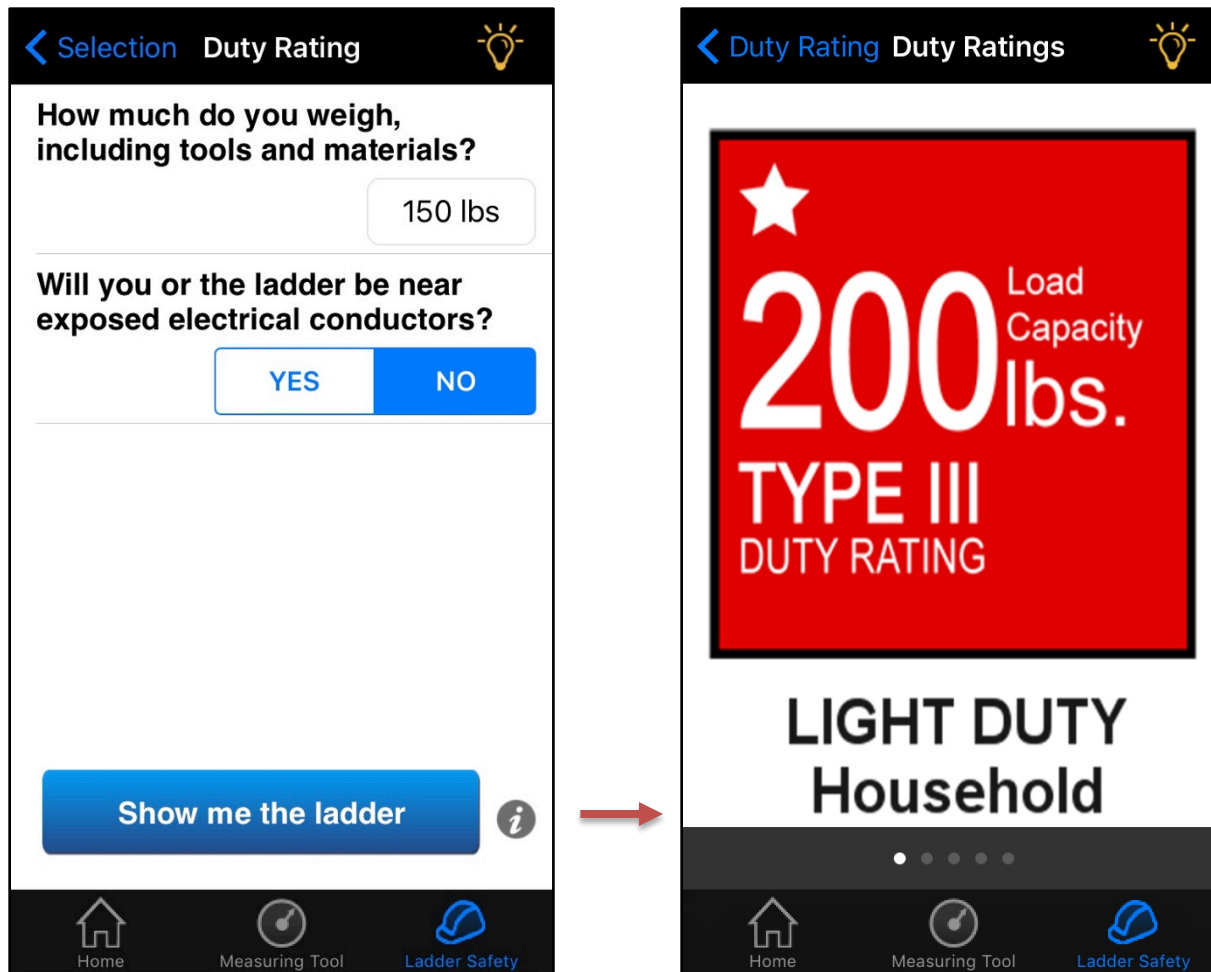

The **Info** button opens a rolling window that shows sample rating stickers.

# 3: Extension Ladder-Inspection

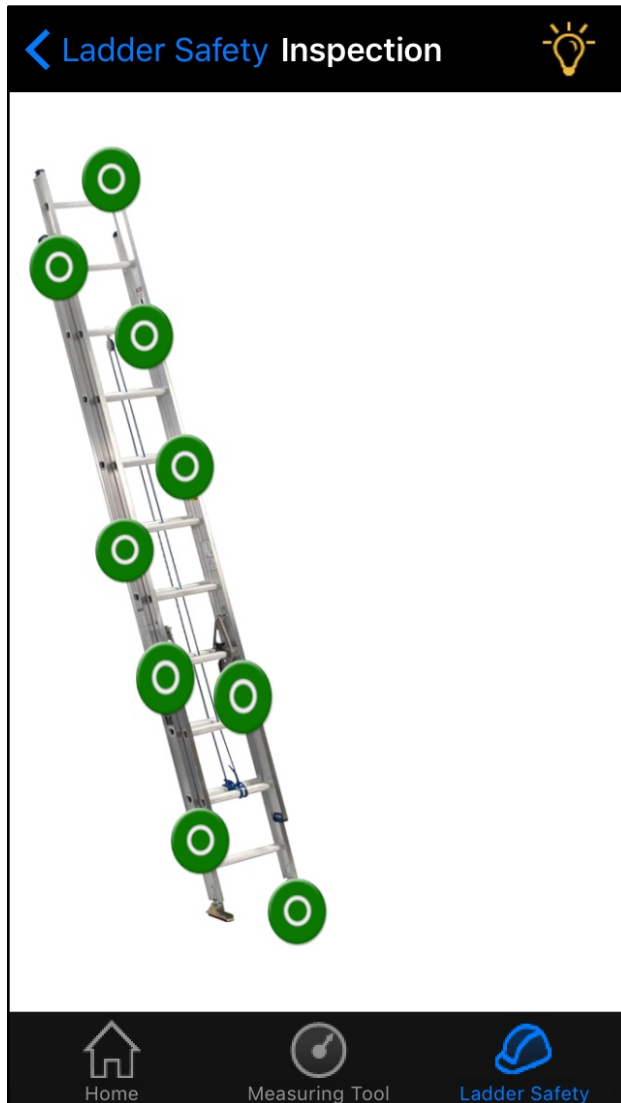

## Buttons



As the user presses each button, an enlarged image and a brief description of the types of damage to look for appears.

- End caps: missing or damaged
- Rungs and step connections: bends, breaks, loose rungs, or missing rungs
- Rope and Pulley: frayed or tangled
- Labels: missing or not readable
- Hardware: loose
- Rung Locks: broken and operates smoothly
- Surfaces: oily, greasy, rusty, or corroded
- Rails: cracks, bends, splits, or corroded
- Feet: missing, worn, or damaged shoes, missing slip-resistant pads, and operates smoothly

After each button is viewed, the color of the button will change.

# 3: Extension Ladder-Inspection (cont'd)

Ladder Safety Inspection

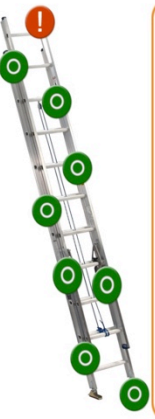

**End Caps**



End caps should not be missing or damaged.

Home Measuring Tool Ladder Safety

Ladder Safety Inspection



**Rungs & Step Connections**



Look for:

- Bends
- Breaks
- Loose rungs
- Missing rungs

Home Measuring Tool Ladder Safety

Ladder Safety Inspection



**Rope & Pulley**



Look for:

- Fraying
- Tangles

Home Measuring Tool Ladder Safety

Ladder Safety Inspection



**Labels**



Are they:

- Missing?
- Not readable?

Home Measuring Tool Ladder Safety

Ladder Safety Inspection

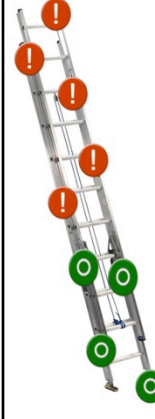

**Hardware**



Look for:

- Loose hardware

Home Measuring Tool Ladder Safety

Ladder Safety Inspection



**Surfaces**



Are they:

- Oily?
- Greasy?
- Rusty?
- Corroded?

Home Measuring Tool Ladder Safety

Ladder Safety Inspection



**Rung Locks**



Look for

- Broken rung locks

Rung locks should operate smoothly.

Home Measuring Tool Ladder Safety

Ladder Safety Inspection



**Rails**



Look for:

- Cracks
- Bends
- Splits
- Corrosion

Home Measuring Tool Ladder Safety

Ladder Safety Inspection



**Feet**



Look for:

- Missing, worn, or damaged shoes
- Missing slip-resistant

Feet should rotate smoothly.

Home Measuring Tool Ladder Safety

# 3: Step Ladder-Inspection

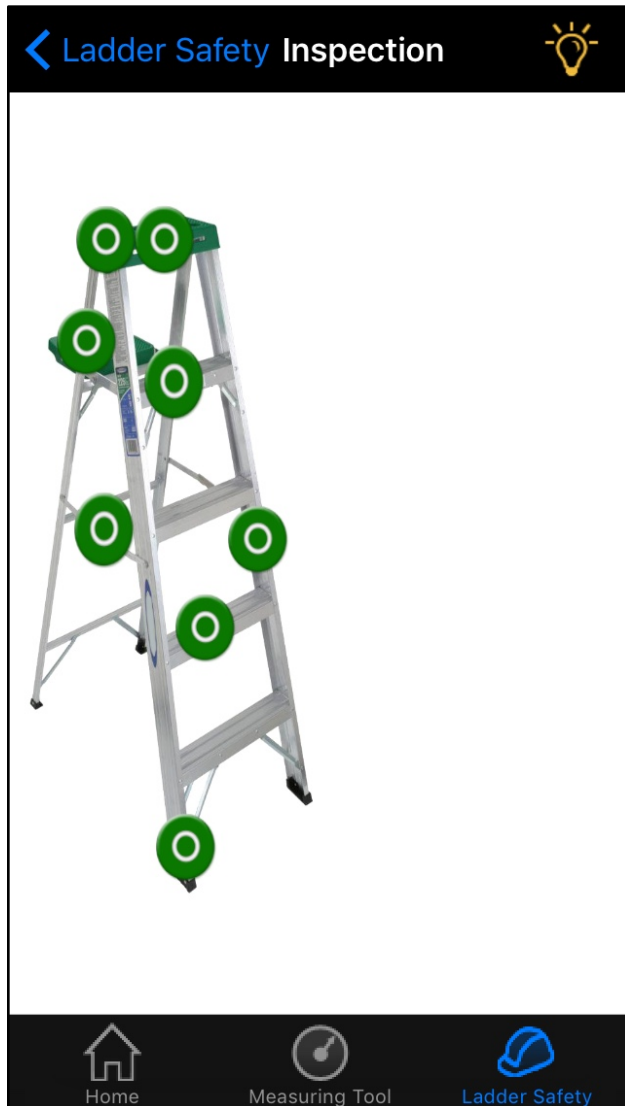

## Buttons

As the user presses each button, an enlarged image and a brief description of the types of damage to look for appears.

- Surfaces: Are they oily, greasy, slippery, or corroded?
- Moveable Parts: Do they operate freely?
- Steps: Are they cracked, bent, loose, or missing?
- Rails: Are they broken, cracked, bent? Are rail shields split or damaged?
- Spreaders: Are they loose or bent? Also look for broken stops, loose hinges, sharp edges
- Labels: Are they missing? Not readable?
- Pail Shelf: Is it loose, bent, missing, or broken?
- Shoes: Are they damaged or worn?

After each button is viewed, the color of the button will change.

# 3: Step Ladder-Inspection (cont'd)

< Ladder Safety Inspection 🔦



**Moveable Parts**



Do they operate freely?

Home Measuring Tool Ladder Safety

< Ladder Safety Inspection 🔦



**Surfaces**



Are they:

- Oily?
- Greasy?
- Slippery?
- Corroded?

Home Measuring Tool Ladder Safety

< Ladder Safety Inspection 🔦



**Pail Shelf**



Is it:

- Loose?
- Bent?
- Missing?
- Broken?

Home Measuring Tool Ladder Safety

< Ladder Safety Inspection 🔦



**Labels**



Are they:

- Missing?
- Not readable?

Home Measuring Tool Ladder Safety

< Ladder Safety Inspection 🔦



**Spreaders**



Are they loose or bent?  
Look for:

- Broken stops
- Loose hinges
- Sharp edges

Home Measuring Tool Ladder Safety

< Ladder Safety Inspection 🔦



**Rails**



Are rails:

- Broken?
- Cracked?
- Bent?

Are rail shields split or damaged?

Home Measuring Tool Ladder Safety

< Ladder Safety Inspection 🔦



**Steps**



Are they:

- Cracked?
- Bent?
- Loose?
- Missing?

Home Measuring Tool Ladder Safety

< Ladder Safety Inspection 🔦



**Shoes**



Are they damaged or worn?

Home Measuring Tool Ladder Safety

# 4: Extension Ladder-Set up

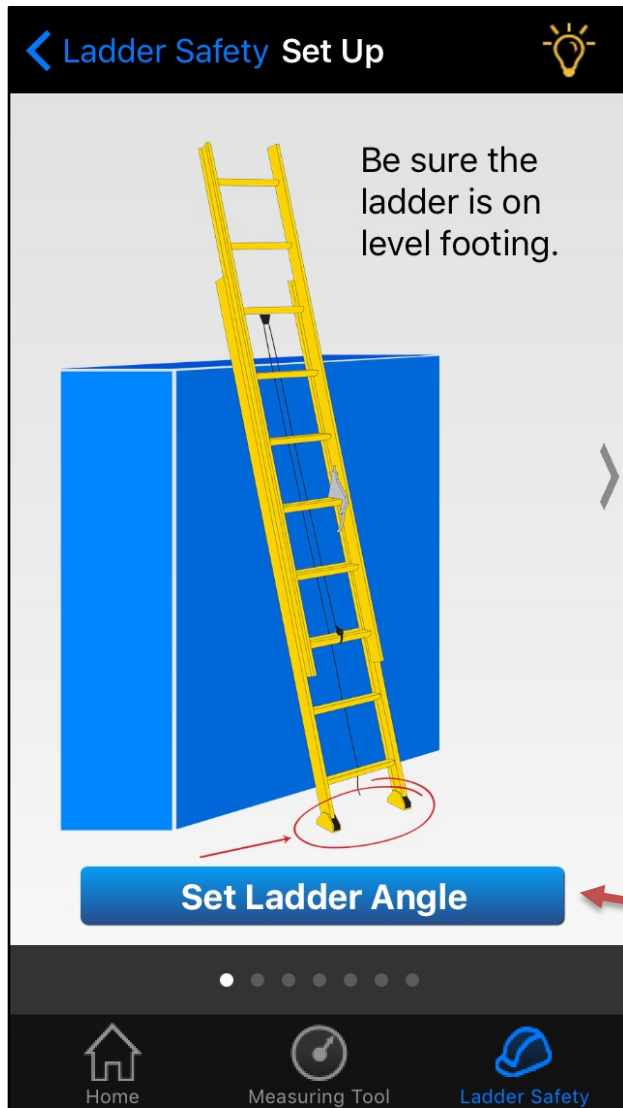

To view all of the images, swipe the page.

- Be sure the ladder is on level footing
- Be sure both upper contact points rest firmly against the structure
- Be sure the ladder extends 3 feet above the structure if climbing to an upper level
- Visually check that both rung locking mechanism are fully engaged
- On slippery or non-level surfaces the ladder base should be restrained

To find out how to setup the ladder properly, tap the **Set Ladder Angle** button.

# 4: Extension Ladder-Set Up (cont'd)

< Ladder Safety Set Up

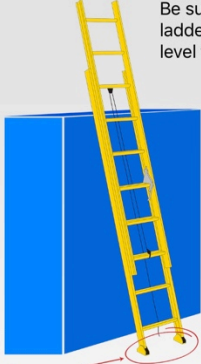

Be sure the ladder is on level footing.

Set Ladder Angle

Home Measuring Tool Ladder Safety

This panel shows a yellow extension ladder leaning against a blue wall. A red circle highlights the base of the ladder on a flat surface. The text instructs to ensure the ladder is on level footing. A blue button at the bottom says 'Set Ladder Angle'. The bottom navigation bar includes icons for Home, Measuring Tool, and Ladder Safety.

< Ladder Safety Set Up



Be sure both upper contact points rest firmly against the structure.

Set Ladder Angle

Home Measuring Tool Ladder Safety

This panel shows a yellow extension ladder leaning against a blue wall. A white circle highlights the top two rungs of the ladder where they contact the wall. The text instructs to ensure both upper contact points rest firmly against the structure. A blue button at the bottom says 'Set Ladder Angle'. The bottom navigation bar includes icons for Home, Measuring Tool, and Ladder Safety.

< Ladder Safety Set Up

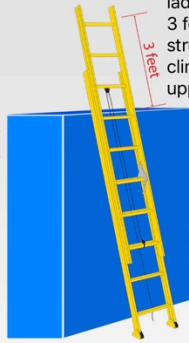

Be sure the ladder extends 3 feet above the structure if climbing to an upper level.

Set Ladder Angle

Home Measuring Tool Ladder Safety

This panel shows a yellow extension ladder leaning against a blue wall. A red double-headed arrow indicates a 3-foot extension above the top edge of the wall. The text instructs to ensure the ladder extends 3 feet above the structure if climbing to an upper level. A blue button at the bottom says 'Set Ladder Angle'. The bottom navigation bar includes icons for Home, Measuring Tool, and Ladder Safety.

< Ladder Safety Set Up



Visually check that both rung locking mechanisms are fully engaged.

Set Ladder Angle

Home Measuring Tool Ladder Safety

This panel shows a yellow extension ladder leaning against a blue wall. Red arrows point to the locking mechanisms on the rungs. The text instructs to visually check that both rung locking mechanisms are fully engaged. A blue button at the bottom says 'Set Ladder Angle'. The bottom navigation bar includes icons for Home, Measuring Tool, and Ladder Safety.

< Ladder Safety Set Up

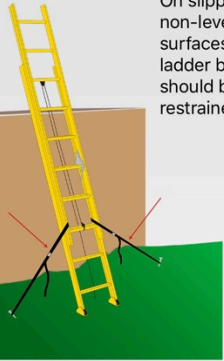

On slippery or non-level surfaces the ladder base should be restrained.

Set Ladder Angle

Home Measuring Tool Ladder Safety

This panel shows a yellow extension ladder leaning against a brown wall on a green, uneven surface. Red lines indicate the base of the ladder is being restrained. The text instructs that on slippery or non-level surfaces, the ladder base should be restrained. A blue button at the bottom says 'Set Ladder Angle'. The bottom navigation bar includes icons for Home, Measuring Tool, and Ladder Safety.

< Ladder Safety Set Up

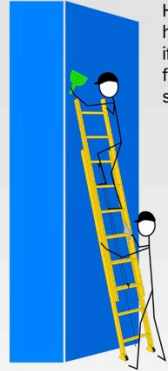

Have someone hold the ladder if it is not feasible to secure it.

Set Ladder Angle

Home Measuring Tool Ladder Safety

This panel shows a yellow extension ladder leaning against a blue wall. A stick figure is shown holding the ladder at the base. The text instructs to have someone hold the ladder if it is not feasible to secure it. A blue button at the bottom says 'Set Ladder Angle'. The bottom navigation bar includes icons for Home, Measuring Tool, and Ladder Safety.

< Ladder Safety Set Up

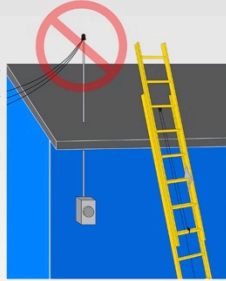

Do not let the ladder contact electrical wires.

Set Ladder Angle

Home Measuring Tool Ladder Safety

This panel shows a yellow extension ladder leaning against a blue wall. A red circle with a diagonal slash is placed over a power outlet and wires near the ladder. The text instructs not to let the ladder contact electrical wires. A blue button at the bottom says 'Set Ladder Angle'. The bottom navigation bar includes icons for Home, Measuring Tool, and Ladder Safety.







# 4: Extension Ladder-Set Up (cont'd)

[← Set Up](#) Setup: Ladder Angle 

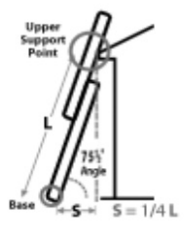
 **Measuring Tool**

 **Body Method**

 **4:1 Ratio**

 Home  Measuring Tool  Ladder Safety

This screen provides three methods for proper ladder setup. To find out more, tap the following buttons:

- Measuring Tool
- Body Method
- 4:1 ratio

# 4: Extension Ladder-Set Up (cont'd)

[← Back](#) More Tips 

## Measuring Tool



To position the ladder, hold the phone flat against the side rail, next to the front edge; move the ladder until you hear a beeping sound.

To check the angle, align the phone on top of the side rail; the optimal angle is shown by a green arrow and a beeping sound.

Home Measuring Tool Ladder Safety

### Measuring Tool

After touching the Measuring Tool icon, a large image appears with the instructions displayed on the right.

#### Instructions:

*To position the ladder: hold the phone flat against the side rail, next to the front edge; move the ladder until you hear a beeping sound.*

*To check the angle: align the phone on top of the side rail; the optimal angle is shown by a green arrow and a beeping sound.*

*To check if the ladder is level sideways, align the phone on a rung/step – level is indicated by a green arrow.*

[← Back](#) More Tips 

## Body Method

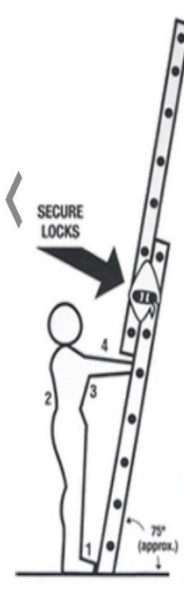

1. Place toes against the bottom of the ladder side rails.

2. Stand erect.

3. Extend hands straight out.

4. The palms of the hands should touch the top of the rung at shoulder level.

Home Measuring Tool Ladder Safety

### Body Method

After touching the Body Method icon, a large image appears with the instructions displayed on the right.

#### Instructions:

1. Place toes against the bottom of the ladder side rails.
2. Stand erect.
3. Extend hands straight out.
4. The palms of the hands should touch the top of the rung at shoulder level.

The user can also swipe through each method.

# 4: Extension Ladder-Set Up (cont'd)

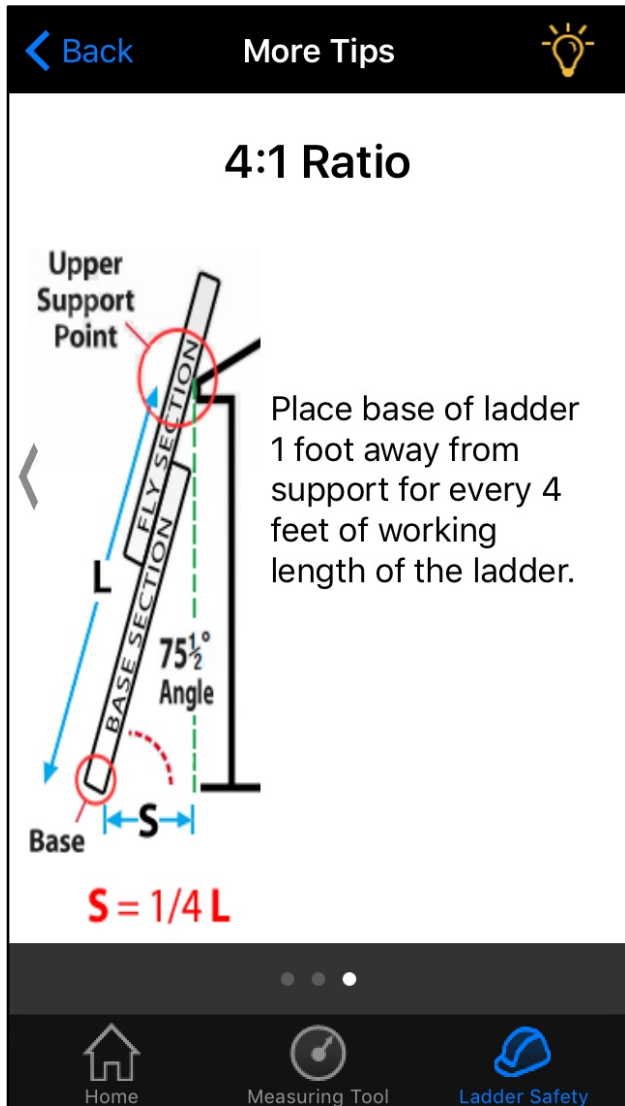

## 4:1 Ratio

After touching the 4:1 Ratio icon, a large image appears with the instructions displayed on the right.

**Instructions:** Place base of ladder 1 foot away from support for every 4 feet of working length of the ladder.

The user can swipe through each method.

# 4: Step Ladder-Set Up



To view all of the images, swipe the page.

- Use only in fully open, locked position on firm, level ground.
- Make sure that all four feet rest firmly on the ground.
- Avoid setting the ladder up near electrical wires.
- When possible, position the ladder so you can face both the ladder and the task.
- Never set a ladder on a scaffold or other object—only on the ground or floor.

To find out how to check the verticality, tap the **Check Verticality** button.

# 4: Step Ladder-Set Up (cont'd)

< Ladder Safety Set Up 

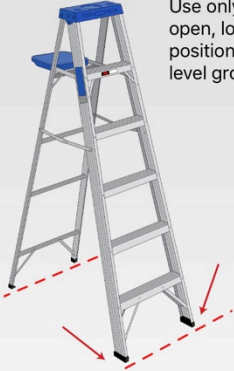

Use only in fully open, locked position on firm, level ground.

**Check Verticality**

Home Measuring Tool Ladder Safety

< Ladder Safety Set Up 

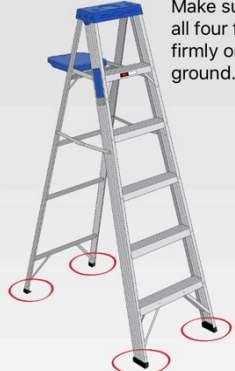

Make sure that all four feet rest firmly on the ground.

**Check Verticality**

Home Measuring Tool Ladder Safety

< Ladder Safety Set Up 

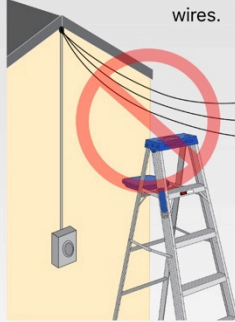

Avoid setting the ladder up near electrical wires.

**Check Verticality**

Home Measuring Tool Ladder Safety

< Ladder Safety Set Up 



When possible, position the ladder so you can face both the ladder and the task.

**Check Verticality**

Home Measuring Tool Ladder Safety

< Ladder Safety Set Up 

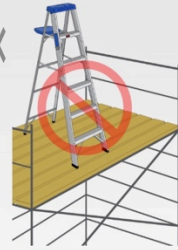

Never set a ladder on a scaffold or other object—only on the ground or floor.

**Check Verticality**

Home Measuring Tool Ladder Safety

# 4: Step Ladder-Set Up (cont'd)



This screen shows the proper way to measure the ladder if it is level.

# 5: Extension Ladder-Proper Use

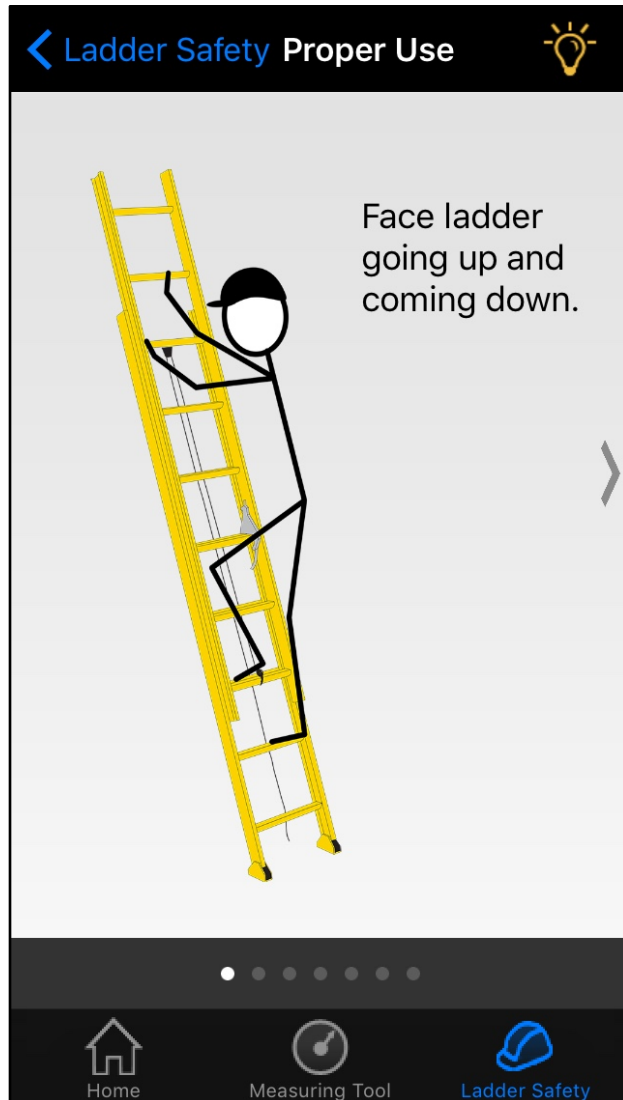

To view all of the images, swipe the page.

- Face ladder going up and coming down
- Keep centered between rails and avoid leaning, stretching, or making moves that could throw you off balance
- Grasp the ladder firmly. Maintain 3-point contact when practical
- Do not carry excessive loads – it may increase your risk of falling
- One person at a time
- Do not stand on the top 3 rungs
- When accessing elevated surfaces, the ladder should extend approximately 3 ft. above the upper support point and the top of the ladder should be secured from movement

# 5: Extension Ladder-Proper Use (cont'd)

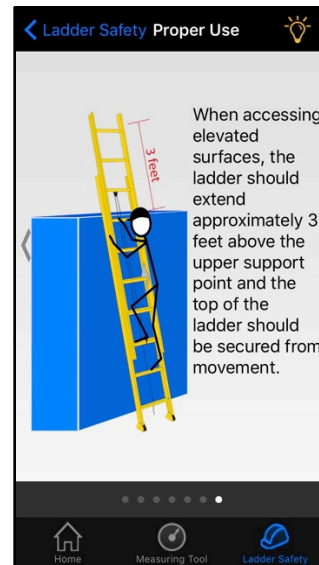
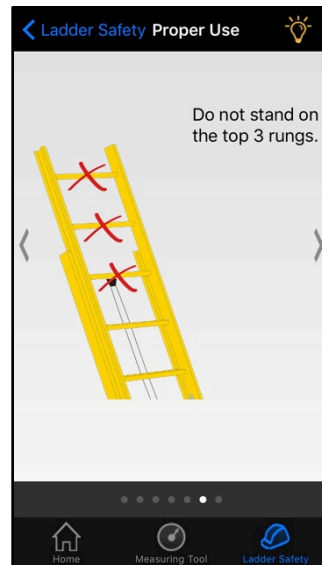
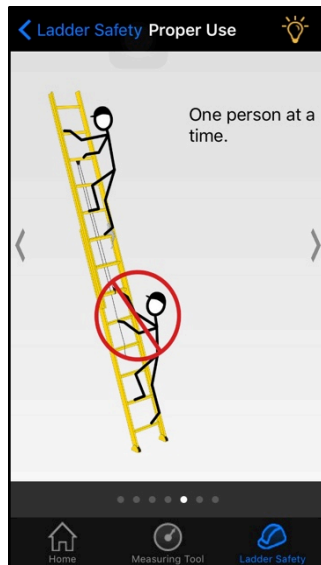
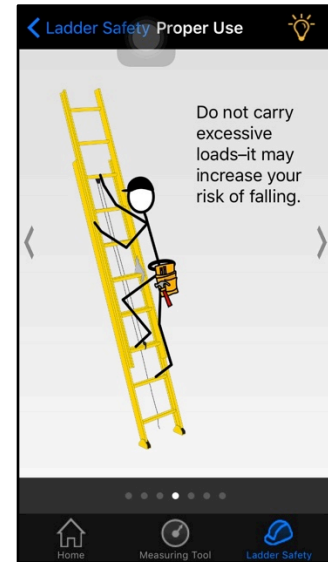
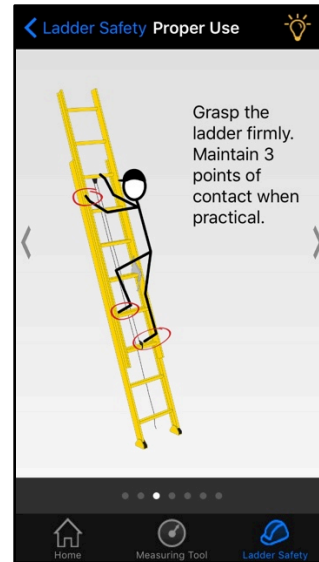
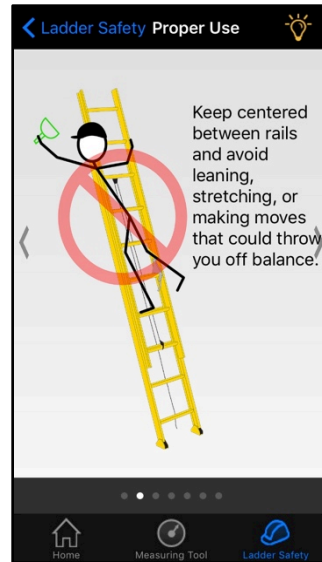
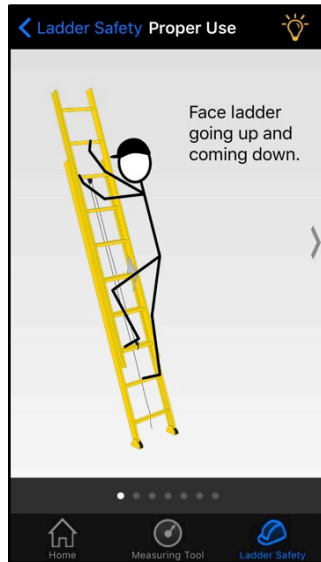



# 5: Step Ladder-Proper Use

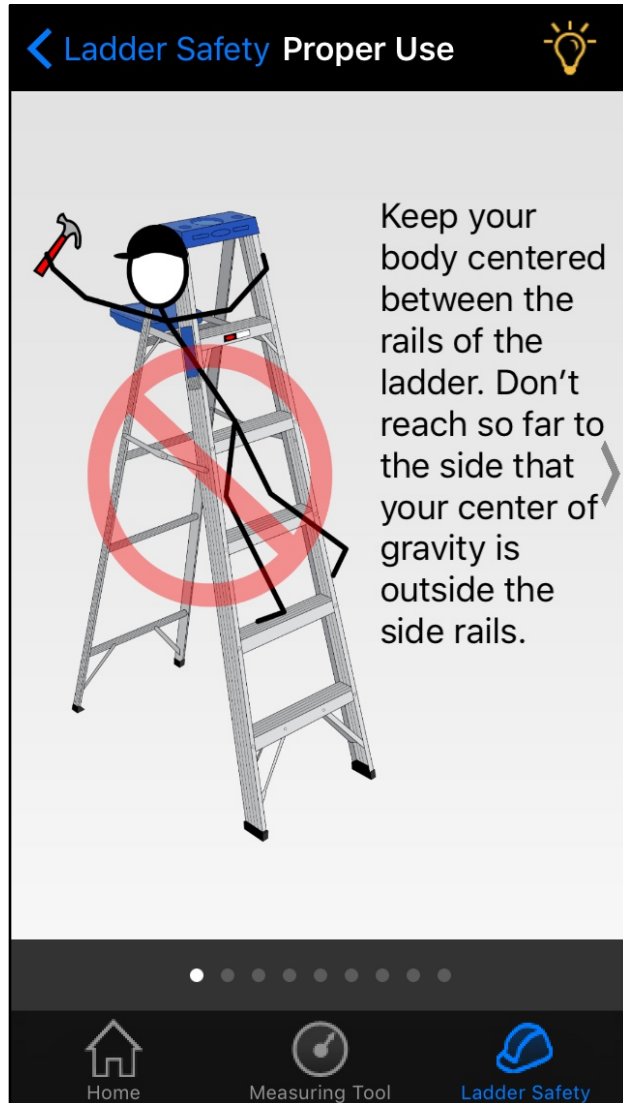

To view all of the images, swipe the page.

- Keep your body centered between the rails of the ladder. Don't reach so far to the side that your center of gravity is outside the side rails.
- Stand no higher than the second step from the top.
- Move the ladder only when no one is on it. Don't try to move it while you are on it.
- One person at a time on the ladder—unless it is designed with steps on both sides.
- Face the ladder and maintain three points of contact when climbing.
- Do not carry tools or materials up or down the ladder. Use a tool belt or have them handed up to you.
- Do not climb the rear section of the ladder unless it is designed with steps.
- Grip and lean into the ladder to maintain balance.
- NEVER climb a stepladder in the closed position or leaning against something.

# 5: Step Ladder-Proper Use (cont'd)

← Ladder Safety Proper Use

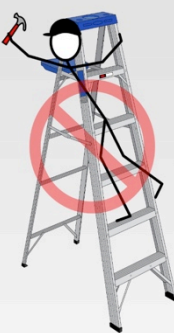

Keep your body centered between the rails of the ladder. Don't reach so far to the side that your center of gravity is outside the side rails.

Home Measuring Tool Ladder Safety

← Ladder Safety Proper Use



Stand no higher than the second step from the top.

Home Measuring Tool Ladder Safety

← Ladder Safety Proper Use



Move the ladder only when no one is on it. Don't try to move it while you are on it.

Home Measuring Tool Ladder Safety

← Ladder Safety Proper Use



One person at a time on the ladder— unless it is designed with steps on both sides.

Home Measuring Tool Ladder Safety

← Ladder Safety Proper Use



Face the ladder and maintain three points of contact when climbing.

Home Measuring Tool Ladder Safety

← Ladder Safety Proper Use



Do not carry tools or materials up or down the ladder. Use a tool belt or have them handed up to you.

Home Measuring Tool Ladder Safety

← Ladder Safety Proper Use



Do not climb the rear section of the ladder unless it is designed with steps.

Home Measuring Tool Ladder Safety

← Ladder Safety Proper Use



Grip and lean into the ladder to maintain balance.

Home Measuring Tool Ladder Safety

← Ladder Safety Proper Use



NEVER climb a step ladder in the closed position or leaning against something.

Home Measuring Tool Ladder Safety

# 6: Extension Ladder-Accessories

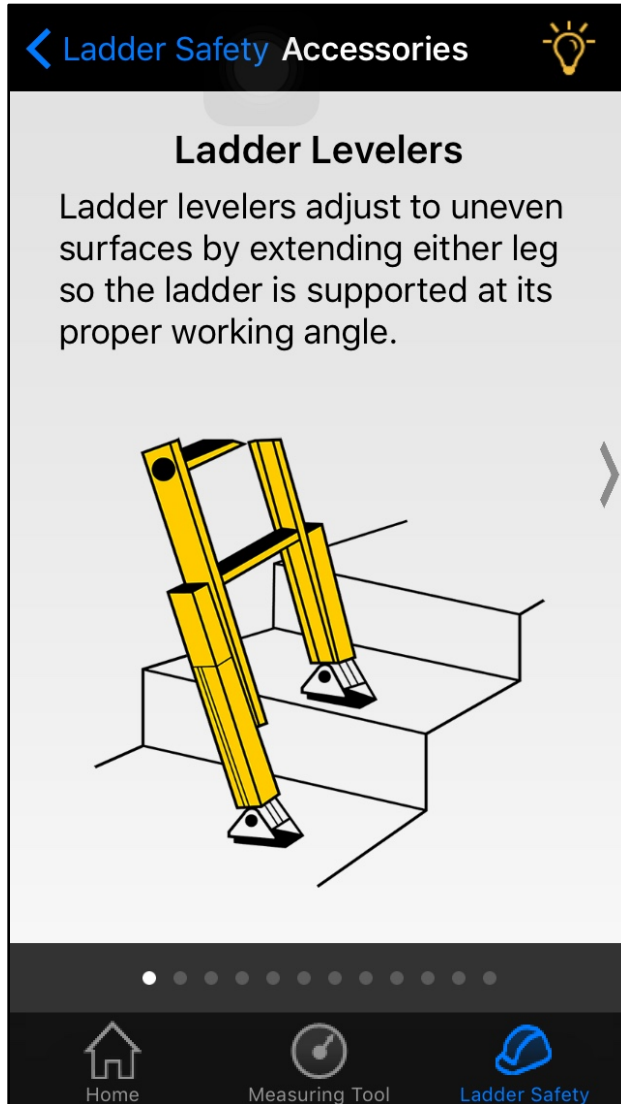

To view the following images and descriptions, swipe the page.

- Ladder levelers
- Ladder feet, spurs, and spur plates
- Stabilizer straps
- Side rail end covers
- Stabilizers and standoffs
- Gutter protectors
- Corner standoffs
- V-rungs
- Pole chain/strap and pole lashes
- Cable (strand) hooks

# 6: Extension Ladder-Accessories (cont'd)

**Ladder Levelers**

Ladder levelers adjust to uneven surfaces by extending either leg so the ladder is supported at its proper working angle.

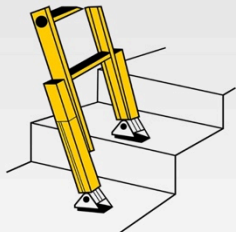

Home Measuring Tool Ladder Safety

**Ladder Feet**

Ladder feet may swivel or articulate. Pads on the feet provide slip resistance for the ladder.

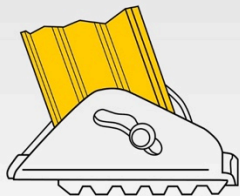

Home Measuring Tool Ladder Safety

**Ladder Spurs**

Spurs on the feet may help secure the ladder against slipping only on surfaces that they can penetrate.

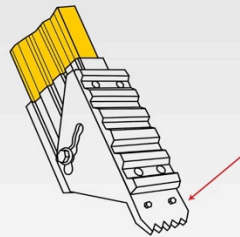

Home Measuring Tool Ladder Safety

**Stabilizer Straps**

A stabilizer strap helps prevent ladder slide-out. You should be able to reach it from the ground.

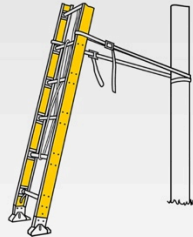

Home Measuring Tool Ladder Safety

**Side Rail End Covers**

Side rail end covers help prevent damage to support surfaces.

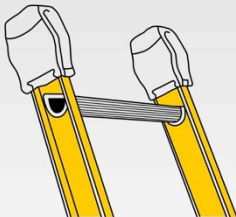

Home Measuring Tool Ladder Safety

**Stabilizers and Standoffs**

Standoffs help to stabilize ladders and prevent damage to support surfaces.

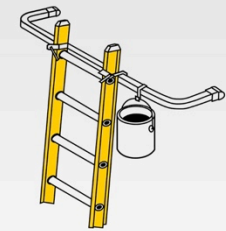

Home Measuring Tool Ladder Safety

**Gutter Standoffs**

Gutter standoffs provide support while protecting gutters.

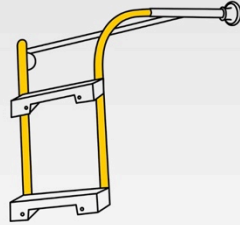

Home Measuring Tool Ladder Safety

**Corner Standoffs**

Corner standoffs are used against corners of buildings to help grip the wall and prevent slipping.

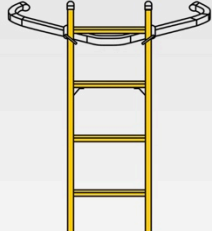

Home Measuring Tool Ladder Safety

# 6: Extension Ladder-Accessories (cont'd)

< Ladder Safety Accessories 

**V-Rungs**

V-rungs allow a ladder to be supported against a tree, pole, or building corner.



Home Measuring Tool Ladder Safety

< Ladder Safety Accessories 

**Pole Chain/Strap**

A pole chain or strap is used to support a ladder against a pole or a column.

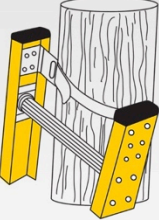

Home Measuring Tool Ladder Safety

< Ladder Safety Accessories 

**Pole Lashes**

A pole lash is used with a v-rung, pole chain or pole strap at the top of a ladder when positioned against a pole or column.

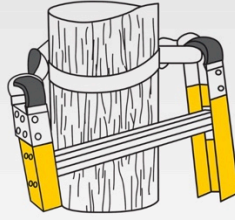

Home Measuring Tool Ladder Safety

< Ladder Safety Accessories 

**Cable (Strand) Hooks**

When a ladder is leaned against a cable, cable hooks keep it from disengaging. They are not meant to be the total support for a ladder.



Home Measuring Tool Ladder Safety

# 6: Step Ladder-Accessories



Since there are no safety related accessories for step ladders, the user is notified that there are no safety accessories on this tab.

# Accessibility Features

The Ladder Safety app features a high-contrast mode and is compatible with the accessibility features built into iOS devices.

Please refer to your device manual for instructions to enable the Accessibility Services.

*\* The speech bubbles, similar to the one below, will denote the VoiceOver responses.*

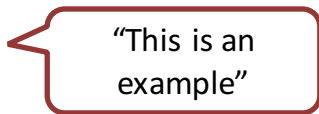

# Home Screen: Ladder Application

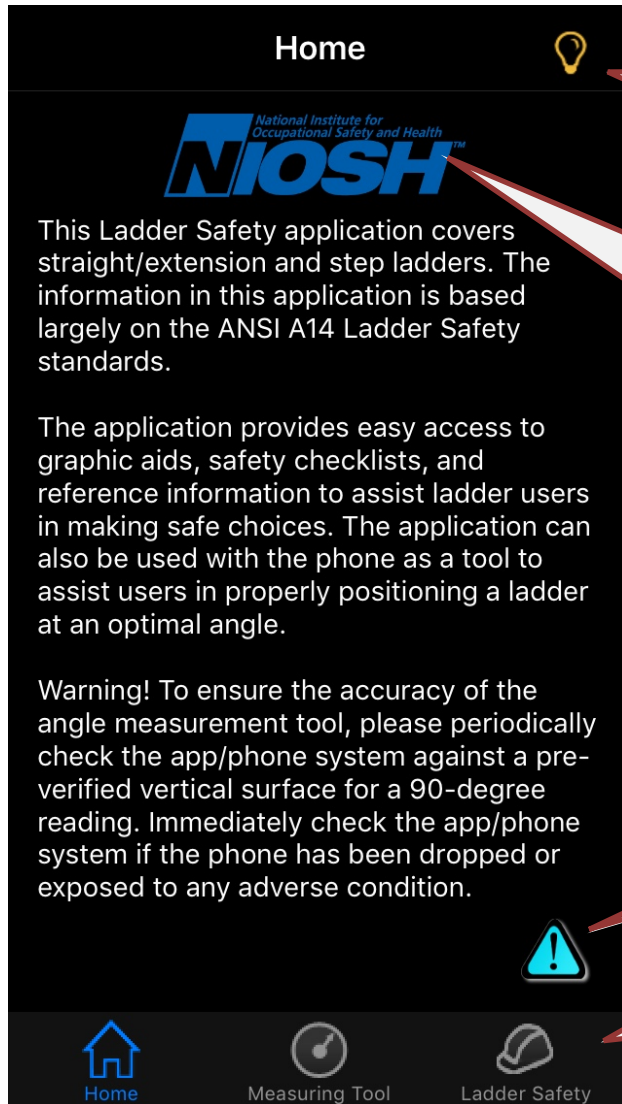

"High contrast"

"NIOSH, National Institute for Occupational Safety and Health"

*The text displayed on the screen*

"Disclaimer"

*The labels for the associated button*

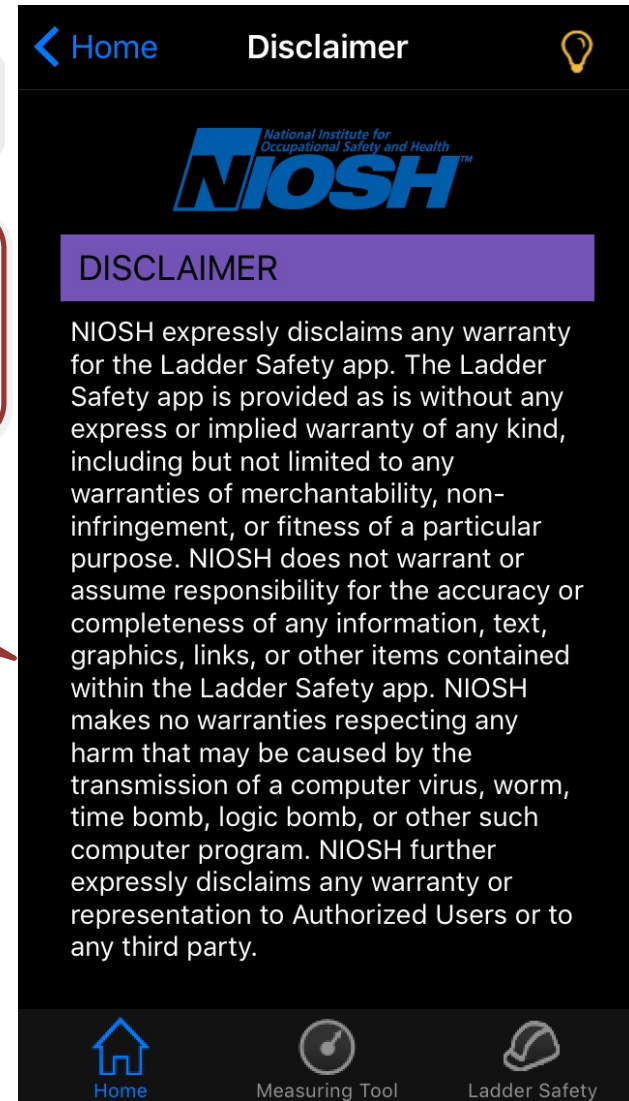

## DISCLAIMER

NIOSH expressly disclaims any warranty for the Ladder Safety app. The Ladder Safety app is provided as is without any express or implied warranty of any kind, including but not limited to any warranties of merchantability, non-infringement, or fitness of a particular purpose. NIOSH does not warrant or assume responsibility for the accuracy or completeness of any information, text, graphics, links, or other items contained within the Ladder Safety app. NIOSH makes no warranties respecting any harm that may be caused by the transmission of a computer virus, worm, time bomb, logic bomb, or other such computer program. NIOSH further expressly disclaims any warranty or representation to Authorized Users or to any third party.



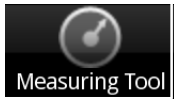

# Measuring Tool

All text displayed will read aloud the associated text.

“NIOSH, National Institute for Occupational Health and Safety”

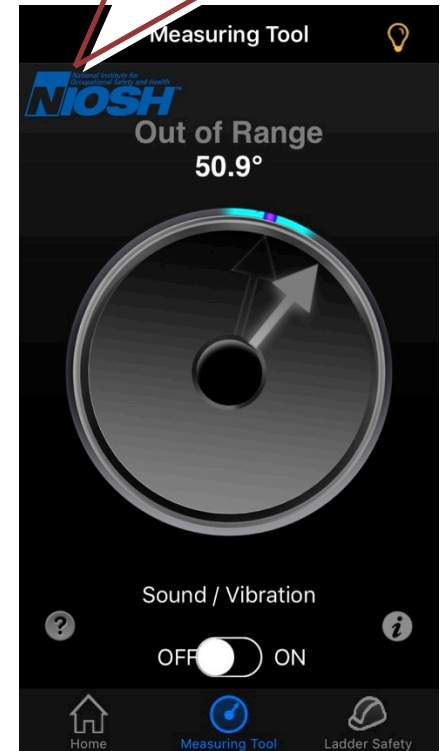
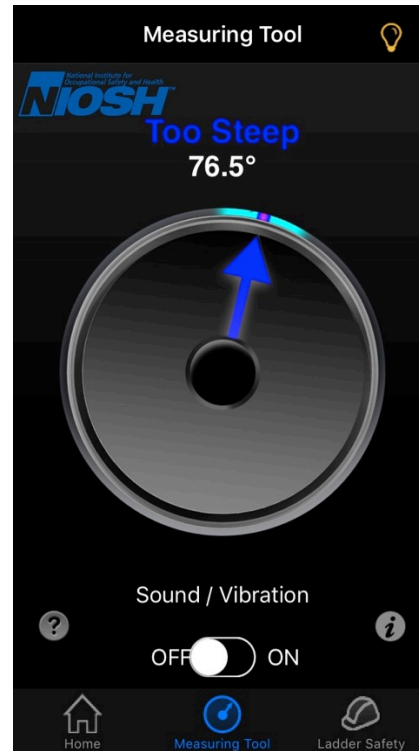
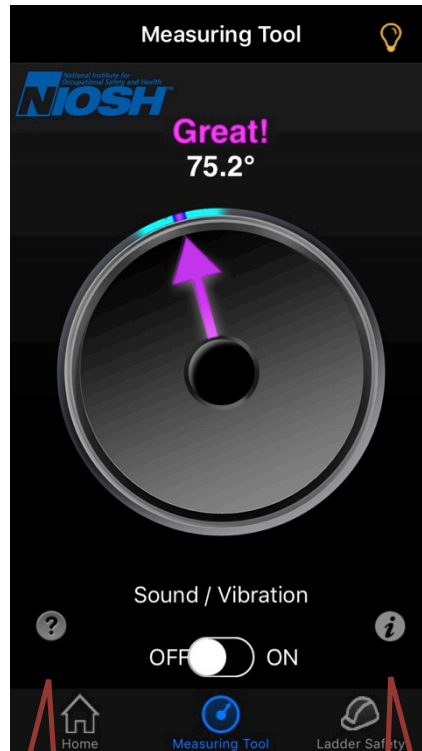
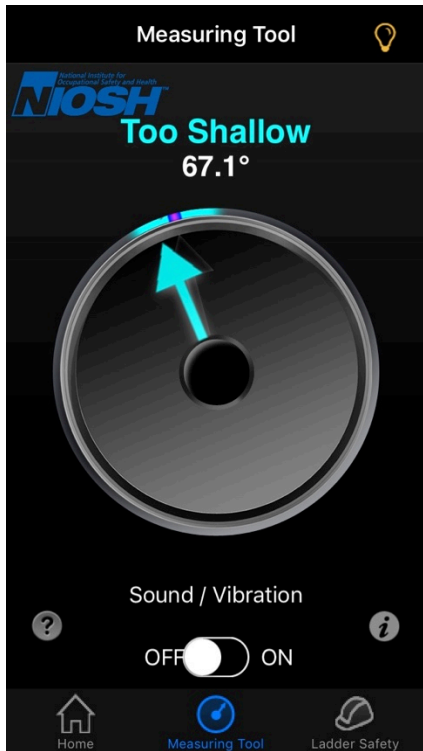

“Help”

“Home”

# Measuring Tool: Verticality

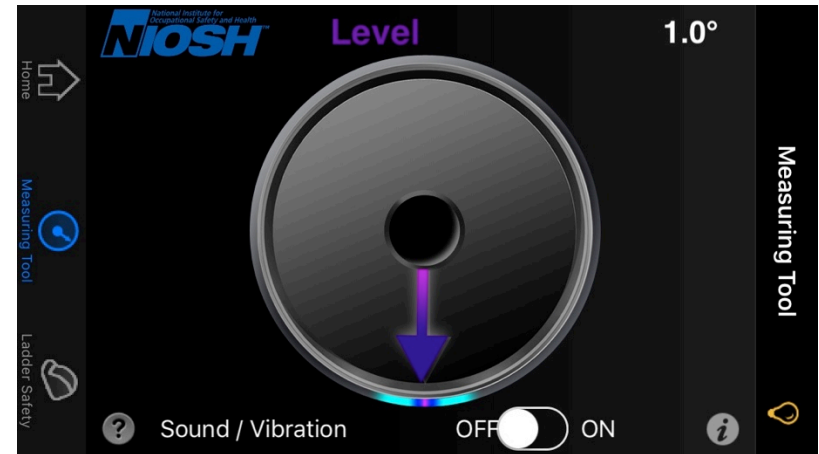

# Measuring Tool



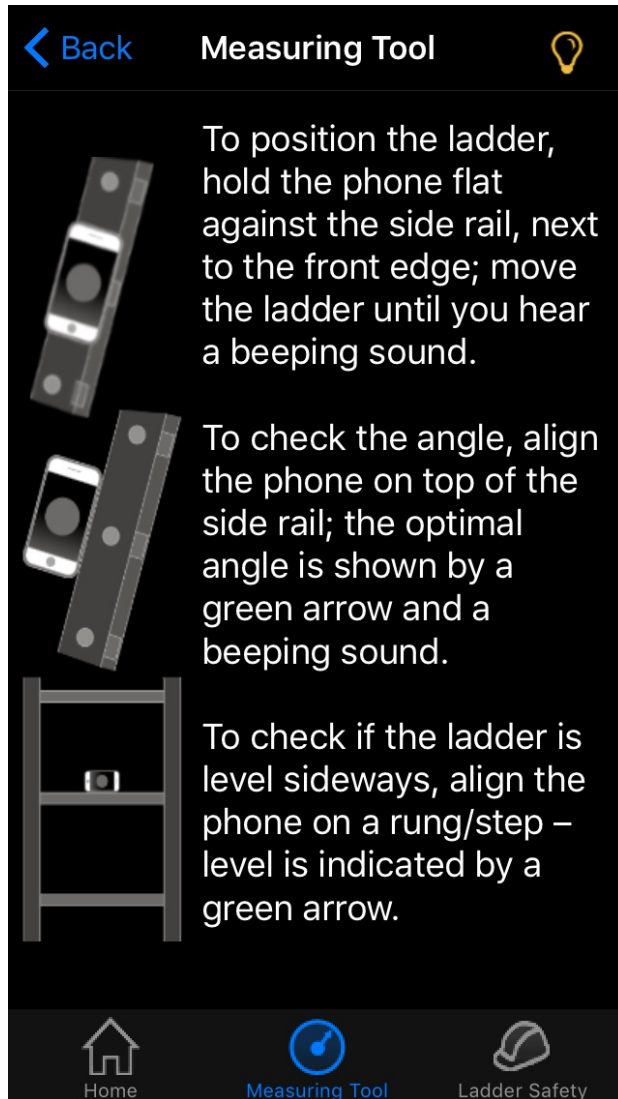









## Help





*The text display as displayed.*

# Ladder Safety

Ladder Safety 

Decision		
Selection		
Inspection		
Set Up		
Proper Use		
Accessories		

Home  Measuring Tool  Ladder Safety 

“Extension/Step Ladder Decision”

“Extension/Step Ladder Selection”

“Extension/Step Ladder Inspection”

“Extension/Step Ladder Set Up”

“Extension/Step Ladder Proper Use”

“Extension/Step Ladder Accessories”

# 1: Decision

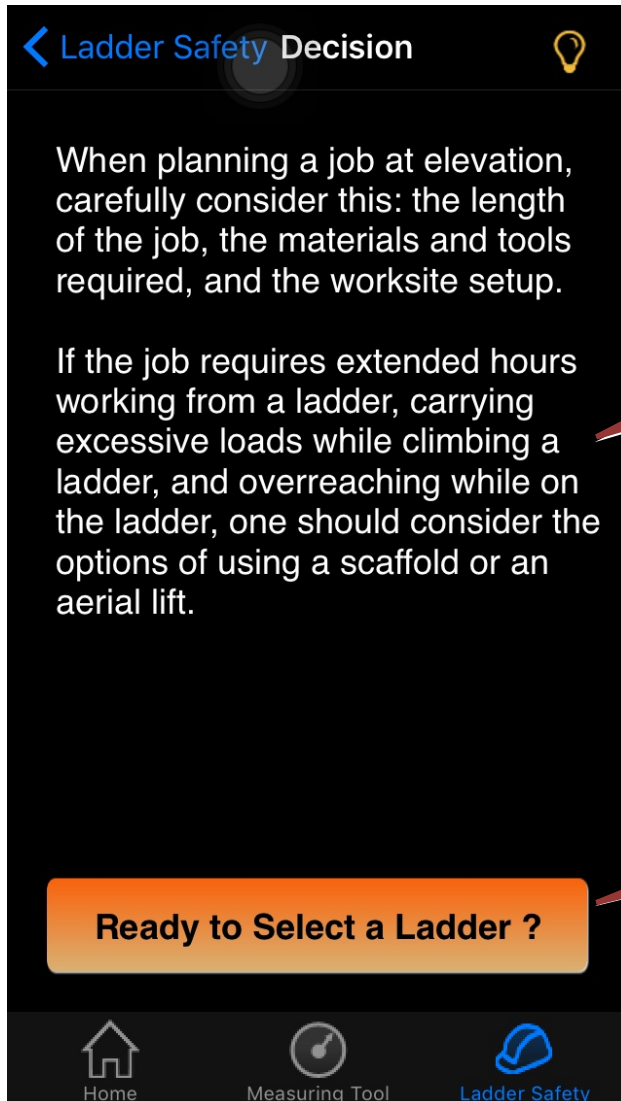

*The text as it appears on the screen.*

*"Ready to select a ladder"*

# 2: Extension Ladder-Selection Home Screen

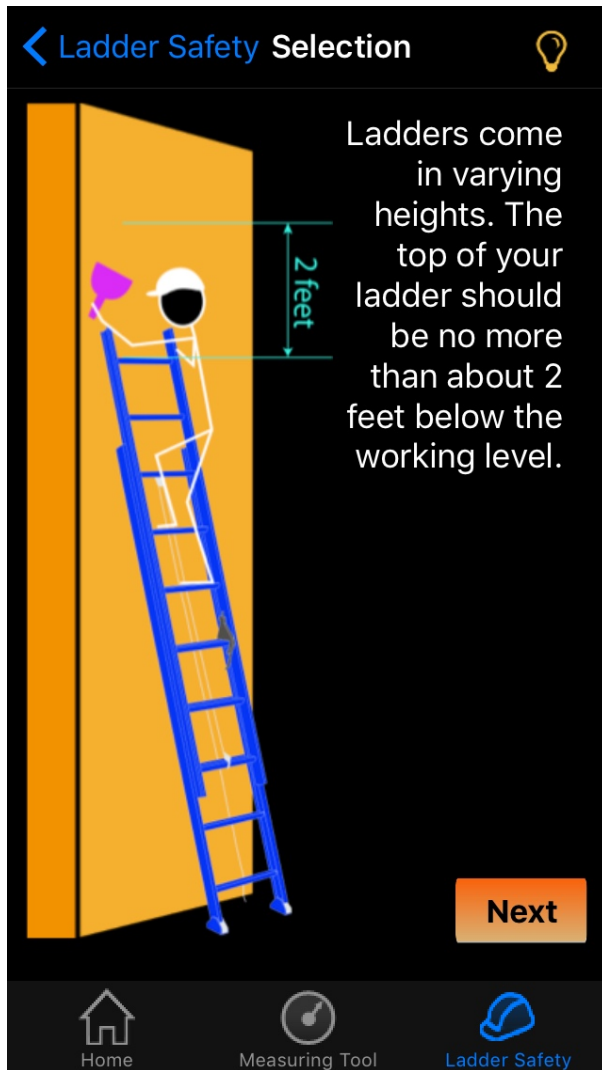

*The text as it appears on the screen.*

“Next”

# 2: Extension Ladder-Selection

The weight displayed (e.g., "150 pounds")

The question as shown on the screen

The question as shown on the screen

"No"

"Yes"

"Info"

The weight displayed (e.g., "190 pounds")

Selection Duty Rating

How much do you weigh, including tools and materials?

150 lbs

Will you or the ladder be near exposed electrical conductors?

YES NO

Show me the ladder

Home Measuring Tool Ladder Safety

Selection Duty Rating

How much do you weigh, including tools and materials?

190 lbs

Will you or the ladder be near exposed electrical conductors?

YES NO

Done

175 lbs

180 lbs

185 lbs

190 lbs

195 lbs

200 lbs

205 lbs

# 2: Extension Ladder-Selection

## Show Me The Ladder

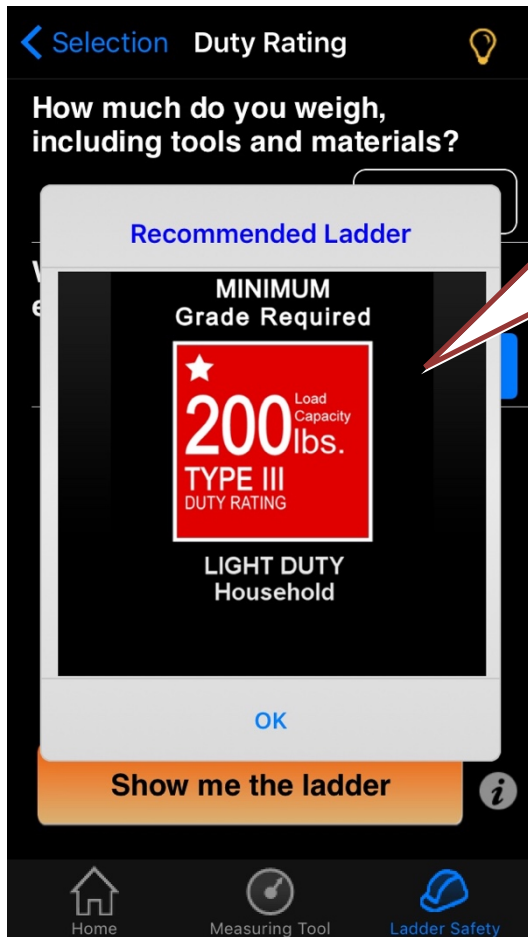

"Recommended ladder, minimum grade required, 200 pounds load capacity, type 3 duty rating, light duty household."

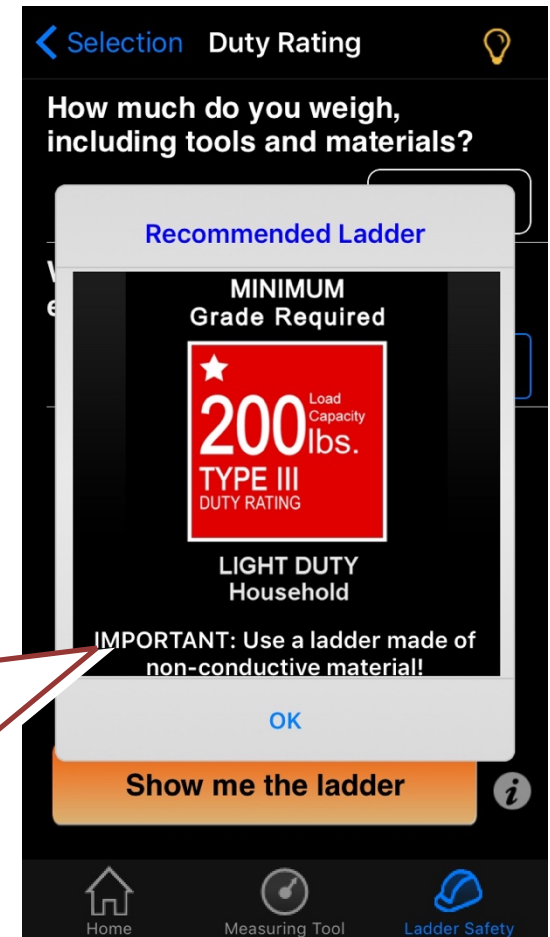

"Recommended ladder, minimum grade required, 200 pounds load capacity, type 3 duty rating, light duty household. Important, use a ladder made of non-conductive material."

*A similar text is read aloud for the Type II, Type I, Type IA, and Type IAA stickers*



# 2: Extension Ladder-Selection

## Sample Rating Stickers

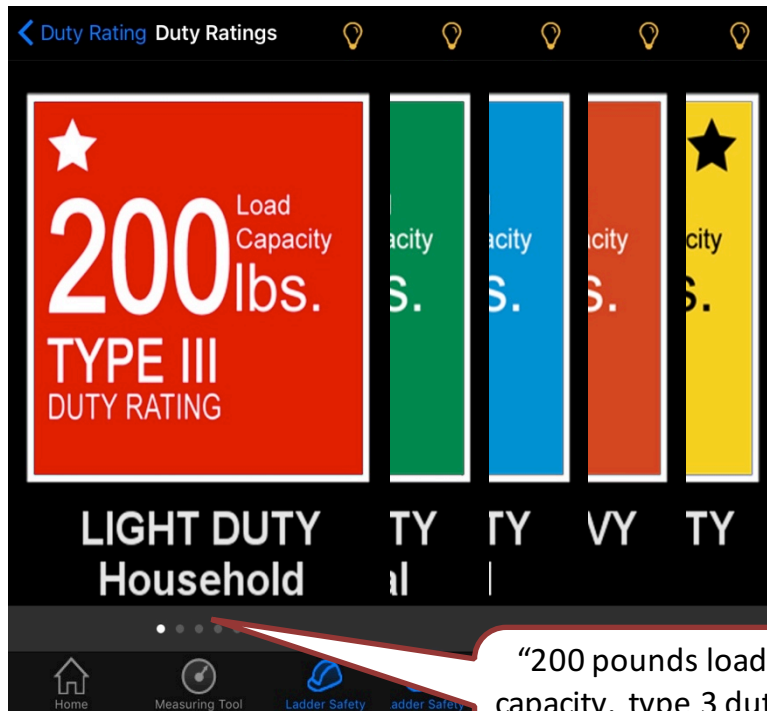

“200 pounds load capacity, type 3 duty rating, light duty household.”

Below is the transcript for all rating stickers.

**Type 3:** “200 pounds load capacity, type 3 duty rating, light duty household.”

**Type 2:** “225 pounds load capacity, type 2 duty rating, medium duty household.”

**Type 1:** “250 pounds load capacity, type 1 duty rating, heavy duty industrial.”

**Type 1A:** “300 pounds load capacity, type 1A duty rating, extra heavy duty industrial.”

**Type 1AA:** “375 pounds load capacity, type 1AA duty rating, special duty industrial.”

# 2: Step Ladder-Selection Home Screen

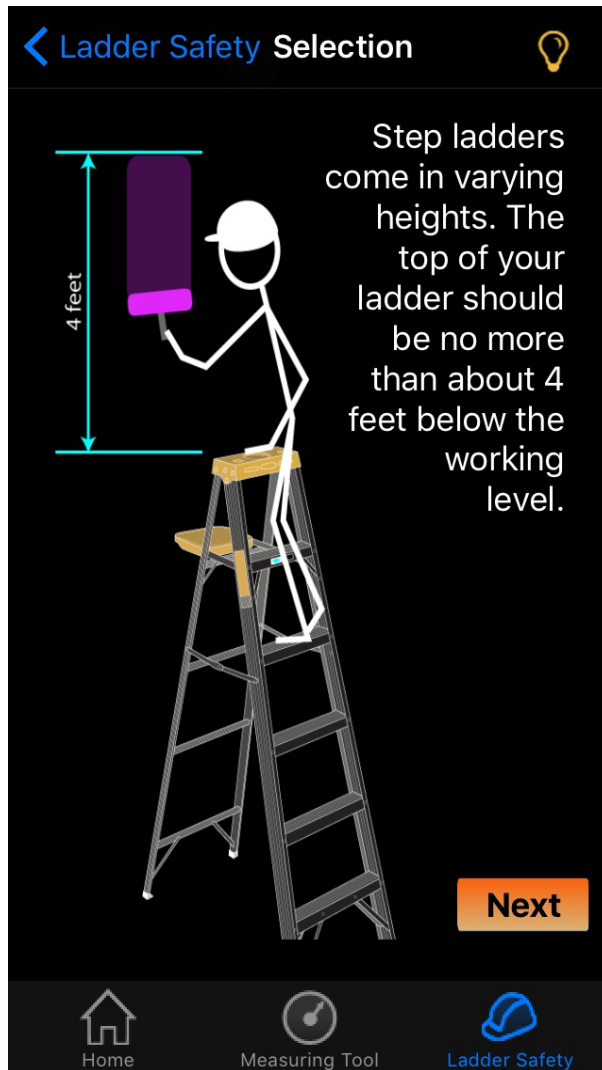

*The text as it appears on the screen.*

*"Next"*

# 2: Step Ladder-Selection

The question as shown on the screen

The question as shown on the screen

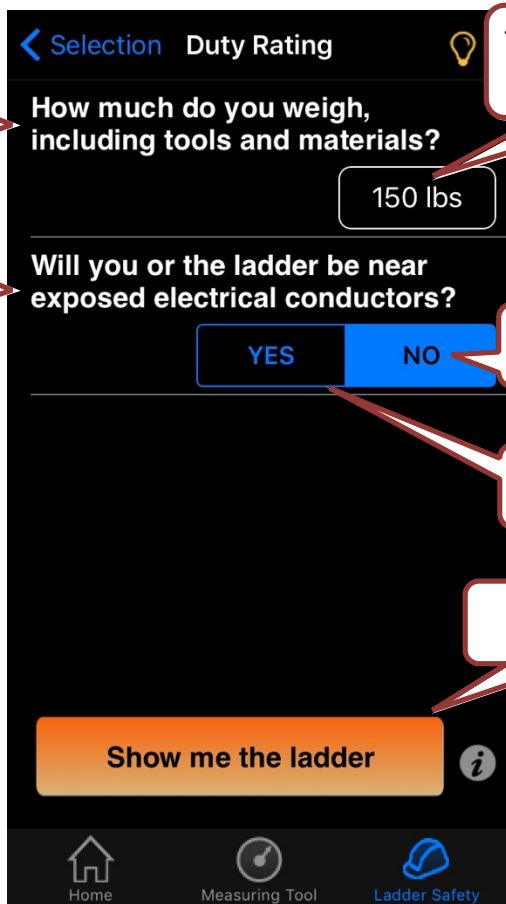

The weight displayed (e.g., "150 pounds")

"No"

"Yes"

"Info"

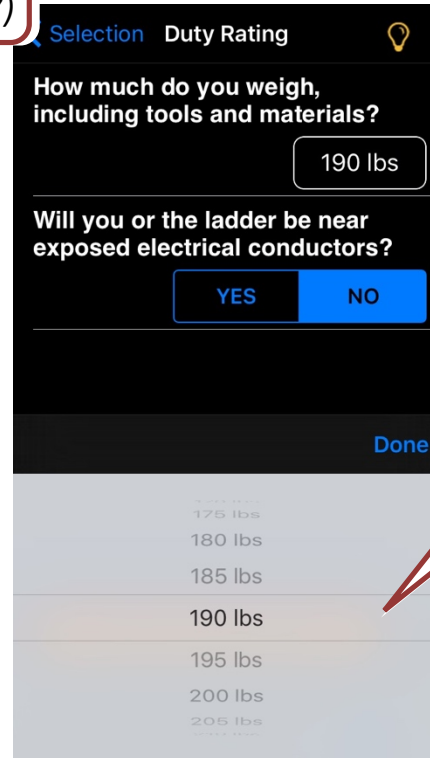

The weight displayed (e.g., "190 pounds")

# 2: Step Ladder-Selection

## Show Me The Ladder

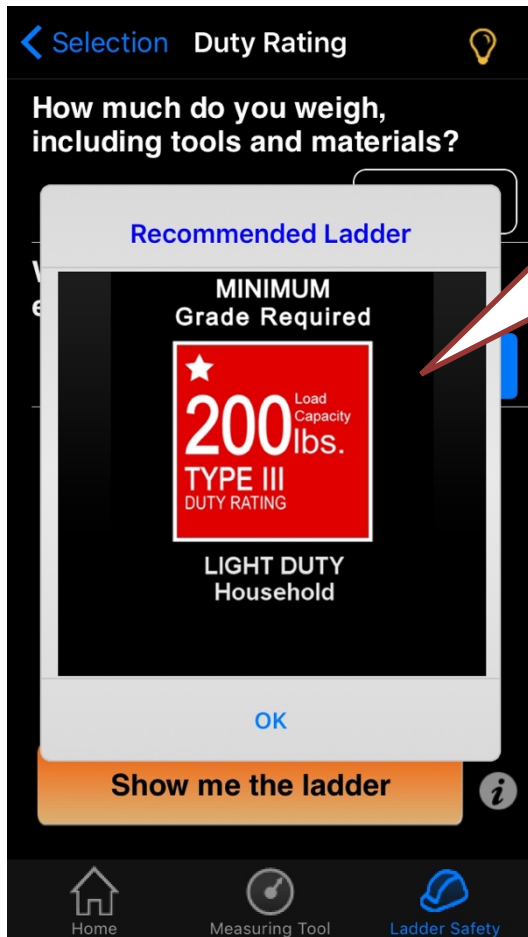

"Recommended ladder, minimum grade required, 200 pounds load capacity, type 3 duty rating, light duty household."

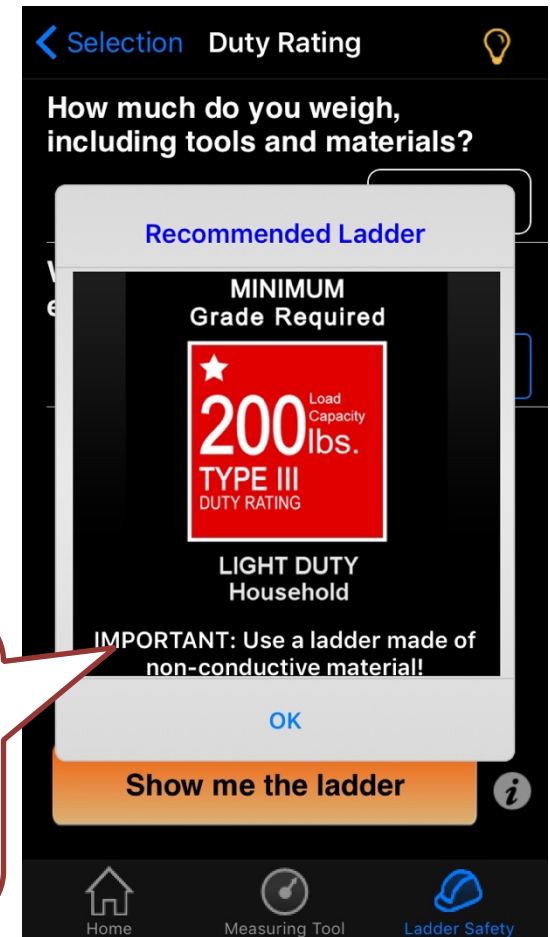

"Recommended ladder, minimum grade required, 200 pounds load capacity, type 3 duty rating, light duty household. Important, use a ladder made of non-conductive material."

*A similar text is read aloud for the Type II, Type I, Type IA, and Type IAA stickers*

# 2: Step Ladder-Selection

## Sample Rating Stickers

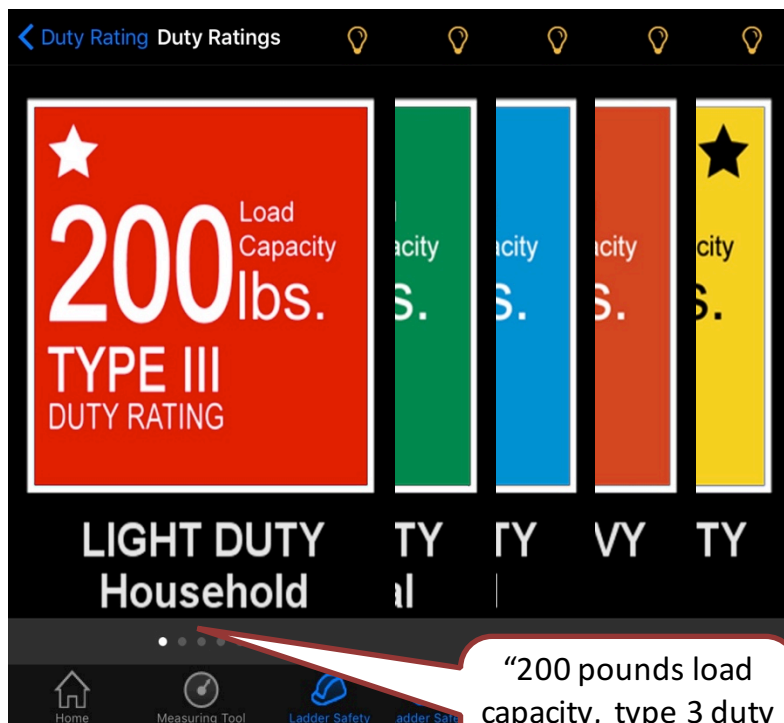

Below is the transcript for all rating stickers.

**Type 3:** “200 pounds load capacity, type 3 duty rating, light duty household.”

**Type 2:** “225 pounds load capacity, type 2 duty rating, medium duty household.”

**Type 1:** “250 pounds load capacity, type 1 duty rating, heavy duty industrial.”

**Type 1A:** “300 pounds load capacity, type 1A duty rating, extra heavy duty industrial.”

**Type 1AA:** “375 pounds load capacity, type 1AA duty rating, special duty industrial.”

“200 pounds load capacity, type 3 duty rating, light duty household.”

# 3: Extension Ladder-Inspection

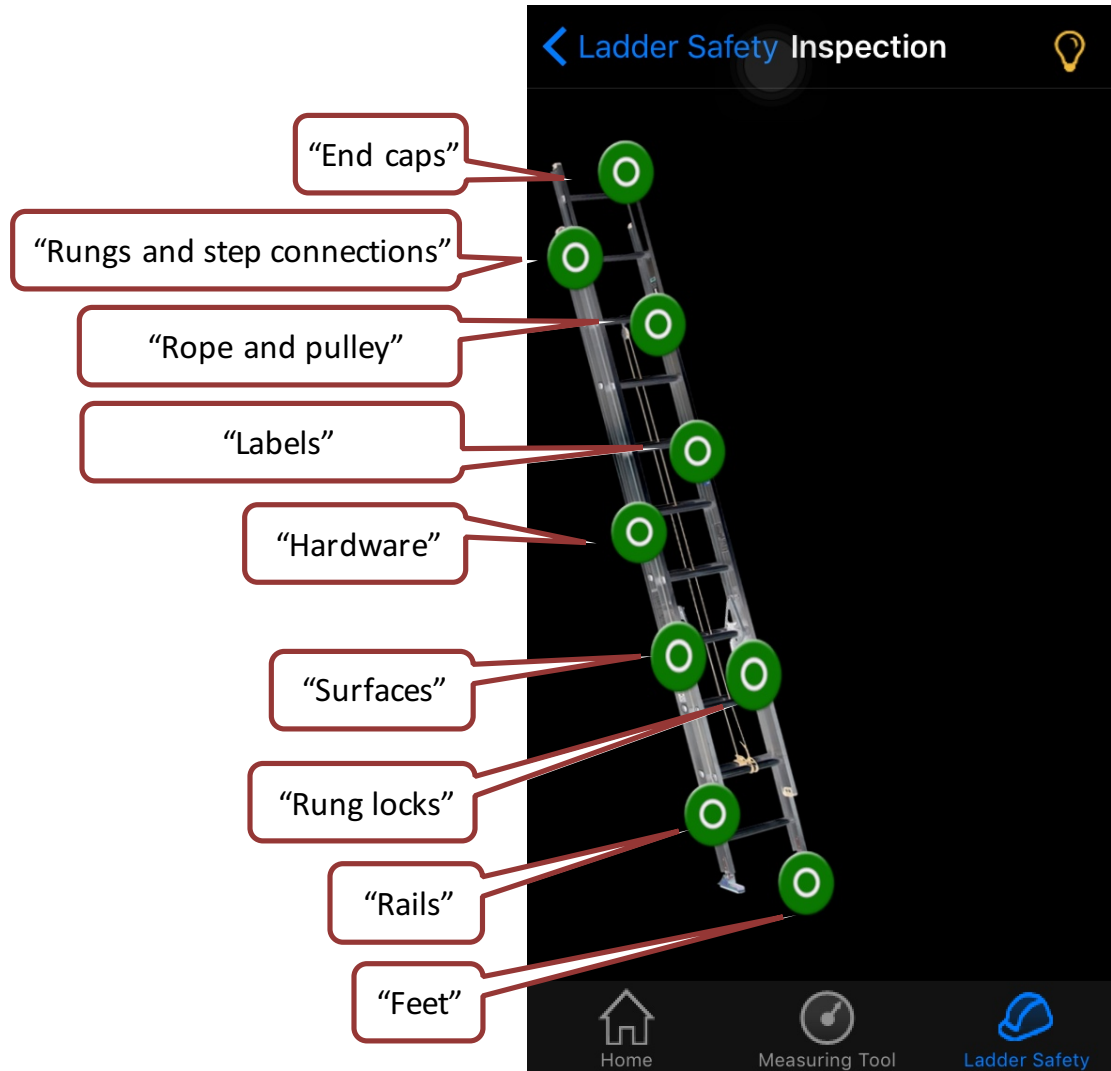

# 3: Extension Ladder-Inspection (cont'd)

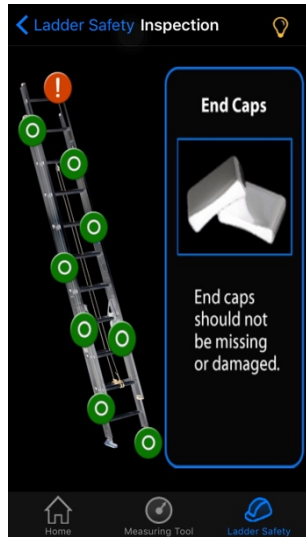

“End caps should not be missing or damaged”

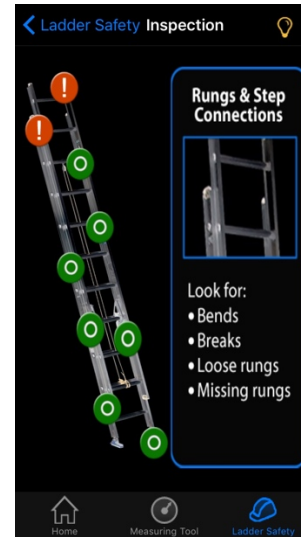

“Look for bends, breaks, loose rungs, and missing rungs on the rungs and step connections?”

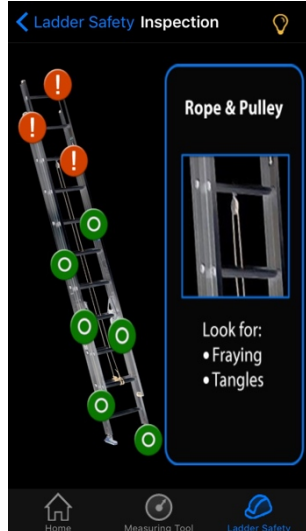

“Look for fraying and tangles on the rope and pulleys”

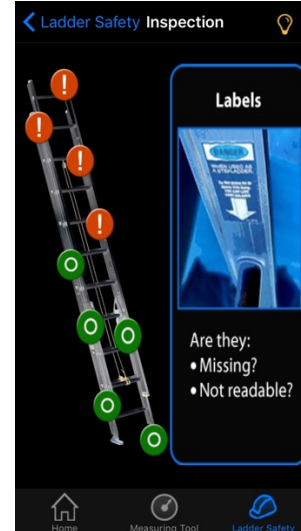

“Are labels missing or not readable?”

# 3: Extension Ladder-Inspection (cont'd)

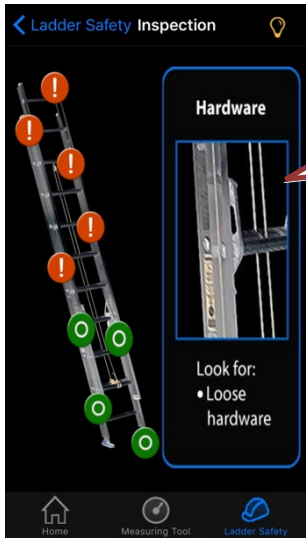

“Look for loose hardware”

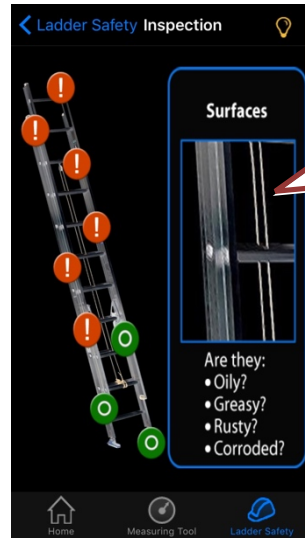

“Are the surfaces oily, greasy, rusty, or corroded?”

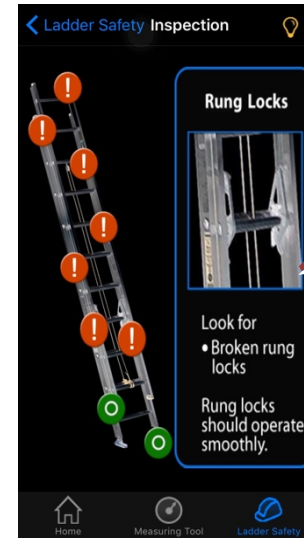

“Look for broken rung locks. Rung locks should operate smoothly.”

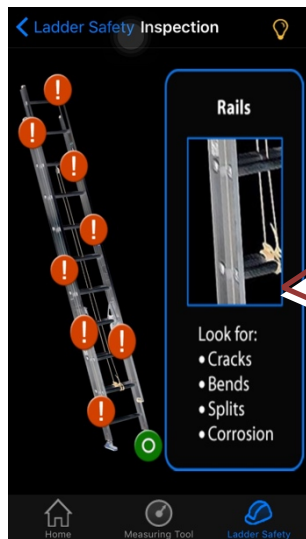

“Look for cracks, bends, splits, and corrosion on the rails”

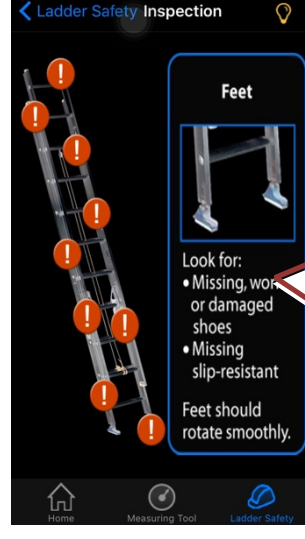

“Look for missing, worn, or damaged shoes on the feet. Look for missing slip-resistant on the feet. The feet should rotate smoothly”



# 3: Step Ladder-Inspection

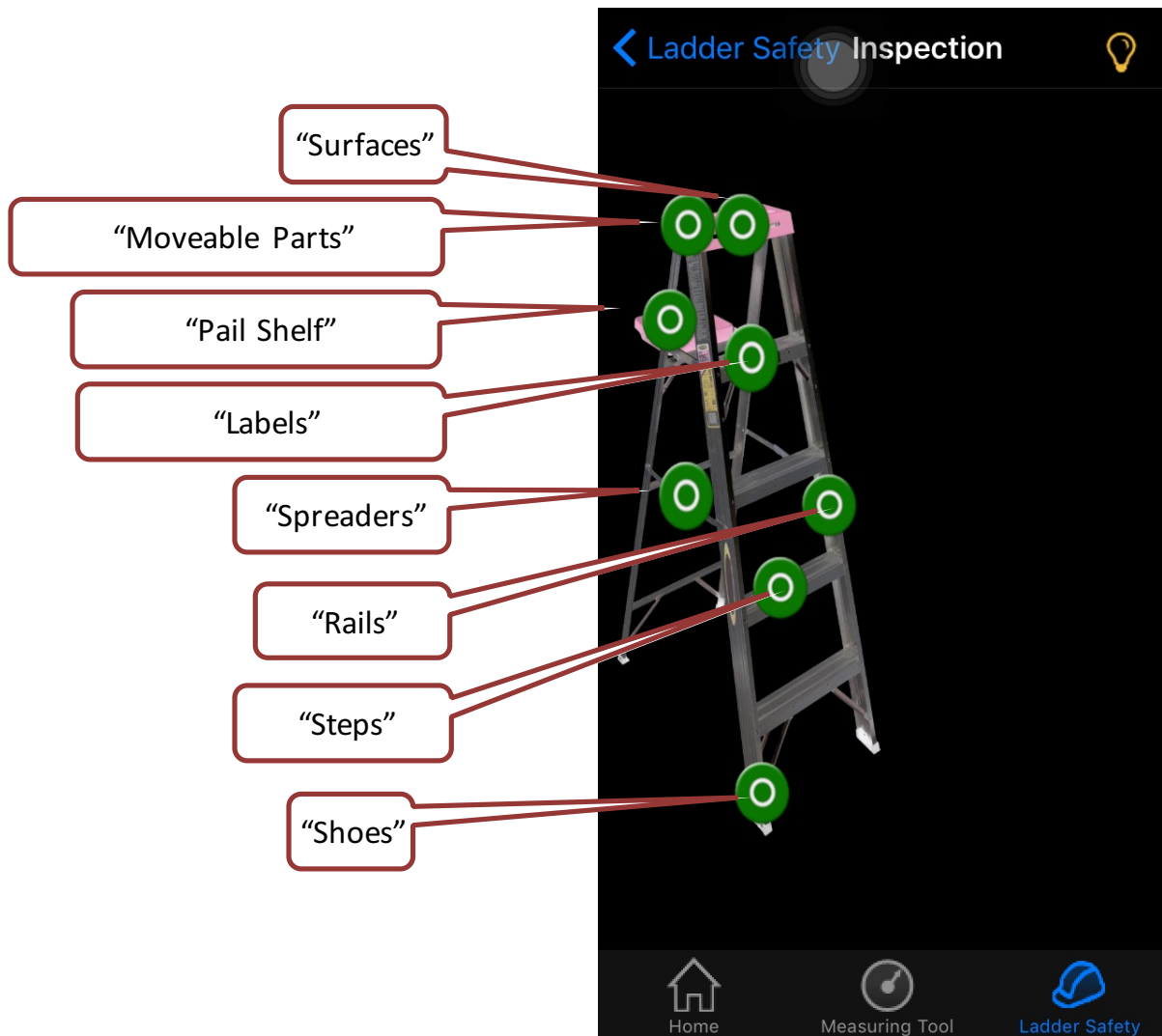

# 3: Step Ladder-Inspection (cont'd)

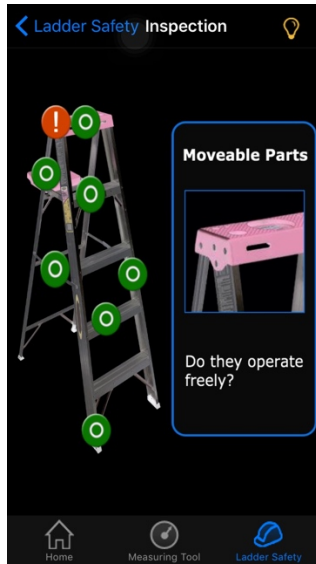

“Do they operate freely?”

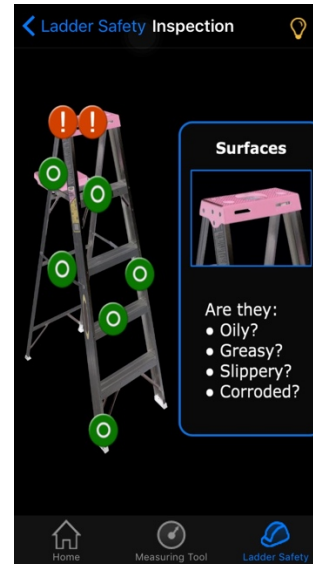

“Are they Oily, Greasy, Slippery Corroded?”

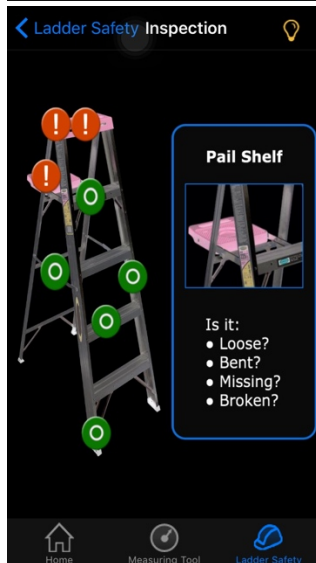

Is it loose, bent, missing, broken?”

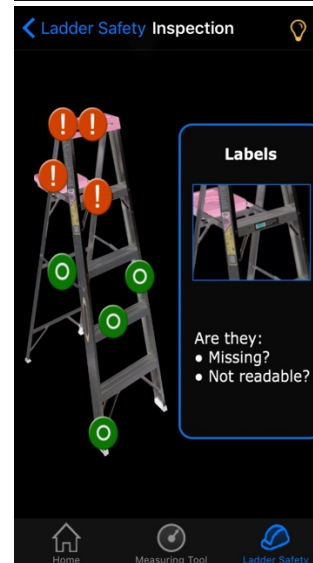

“Are they missing, not readable?”

# 3: Step Ladder-Inspection (cont'd)

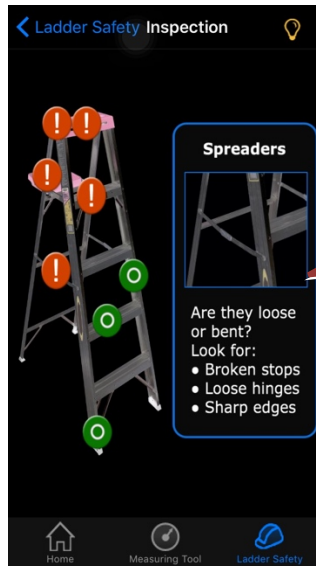

“Are they loose or bent. Look for broken stops, loose hinges, sharp edges”

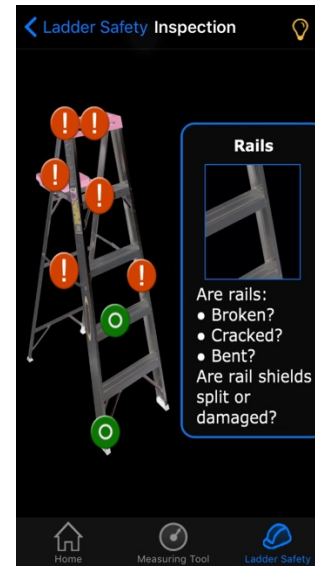

“Are rails broken, cracked, bent. Are rail shields split or damaged?”

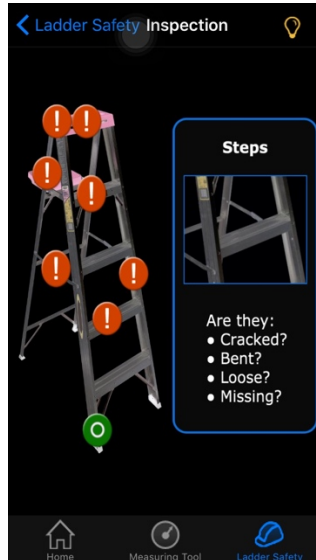

“Are they cracked, bent, loose, missing?”

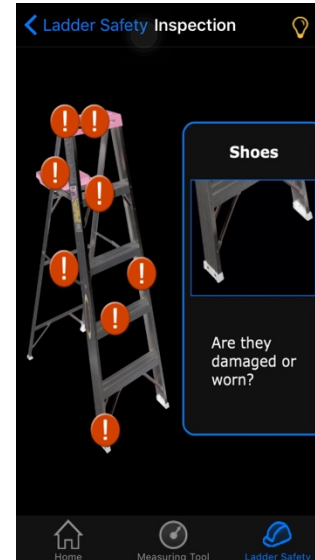

“Are they damaged or worn?”

# 4: Extension Ladder-Set Up

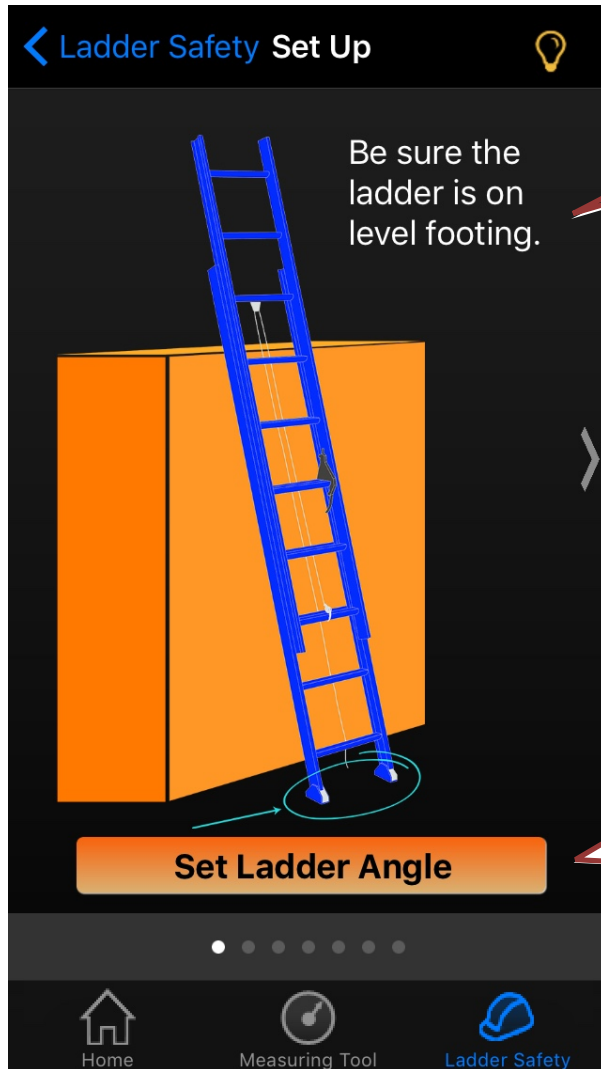

*The text as it appears on the screen.*

"Set ladder angle"

# 4: Extension Ladder-Set Up (cont'd)

**Screenshot 1:** Be sure the ladder is on level footing. **Set Ladder Angle**

**Screenshot 2:** Be sure both upper contact points rest firmly against the structure. **Set Ladder Angle**

**Screenshot 3:** Be sure the ladder extends 3 feet above the structure if climbing to an upper level. **Set Ladder Angle**

**Screenshot 4:** Visually check that both rung locking mechanisms are fully engaged. **Set Ladder Angle**

**Screenshot 5:** On slippery or non-level surfaces the ladder base should be restrained. **Set Ladder Angle**

**Screenshot 6:** Have someone hold the ladder if it is not feasible to secure it. **Set Ladder Angle**

**Screenshot 7:** Do not let the ladder contact electrical wires. **Set Ladder Angle**

# 4: Extension Ladder-Set Up (cont'd)

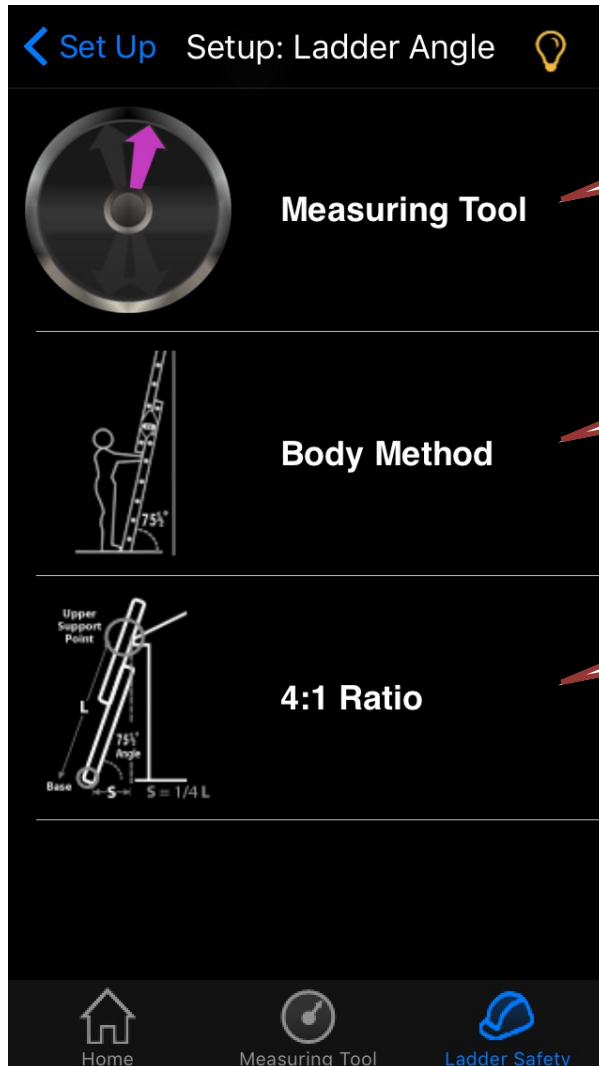

"How to use the measuring tool"

"How to use the body method"

"How to use the four to one ratio"

# 4: Extension Ladder-Set Up (cont'd)

[← Back](#) More Tips 

## Measuring Tool



To position the ladder, hold the phone flat against the side rail, next to the front edge; move the ladder until you hear a beeping sound.

To check the angle, align the phone on top of the side rail; the optimal angle is shown by a green arrow and a beeping sound.

Home Measuring Tool Ladder Safety

*The instructions as it appears on the screen.*

[← Back](#) More Tips 

## Body Method

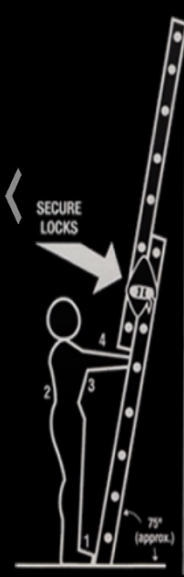

1. Place toes against the bottom of the ladder side rails.

2. Stand erect.

3. Extend hands straight out.

4. The palms of the hands should touch the top of the rung at shoulder level.

Home Measuring Tool Ladder Safety

*The instructions as it appears on the screen.*

# 4: Extension Ladder-Set Up (cont'd)

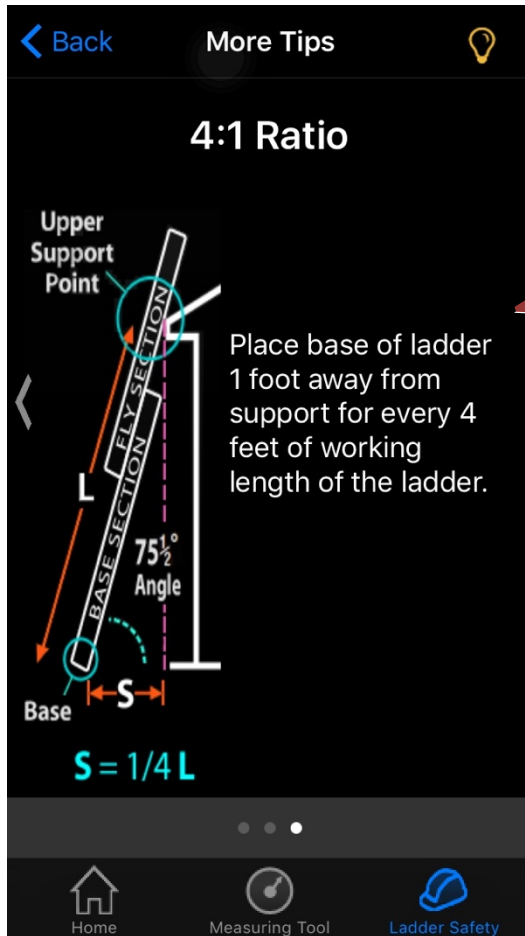

*The instructions as it appears on the screen.*



# 4: Step Ladder-Set Up

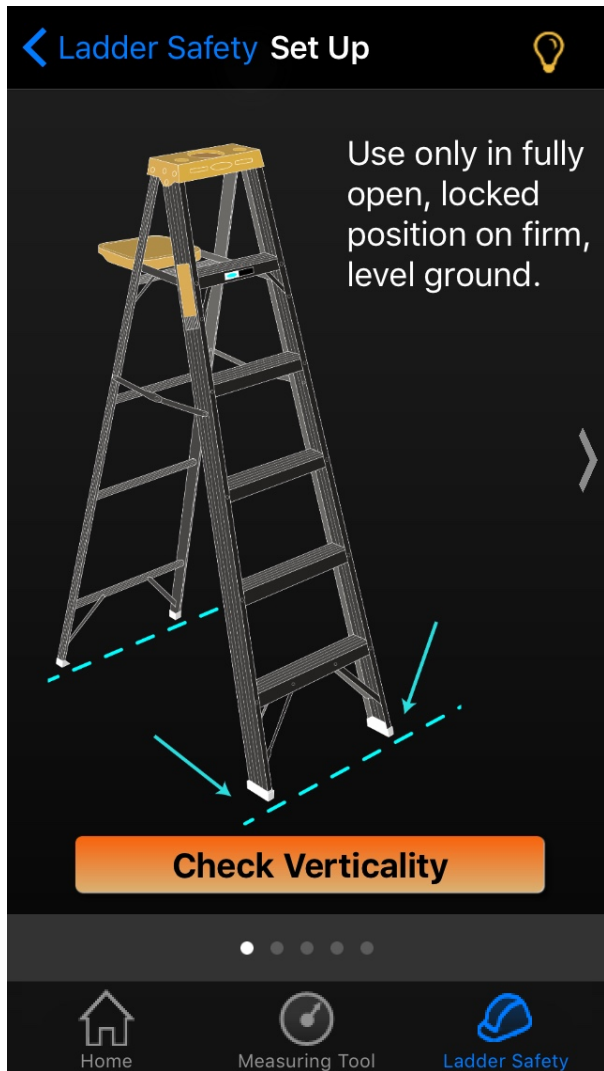

*The text as it appears on the screen.*

“Check Verticality”

# 4: Step Ladder-Set Up (cont'd)

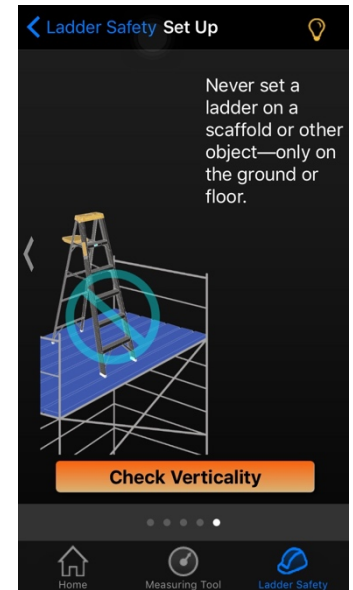
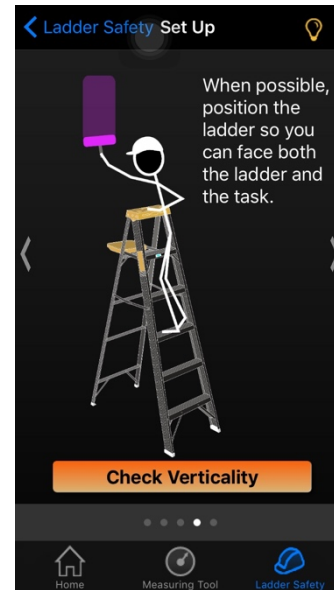
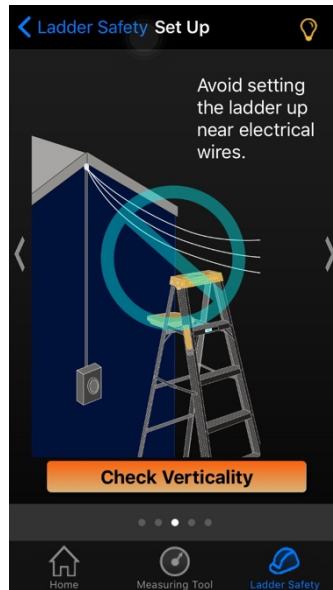
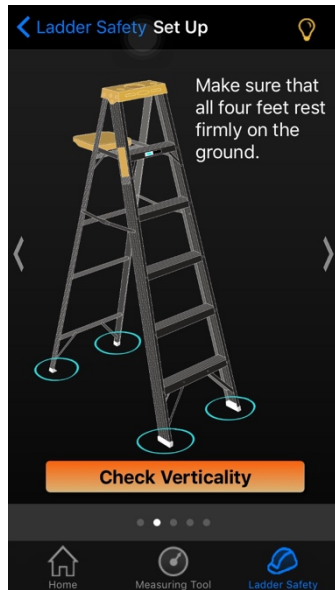
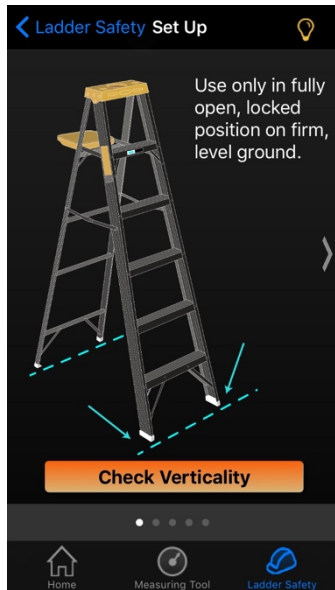

## 4: Step Ladder-Set Up (cont'd)

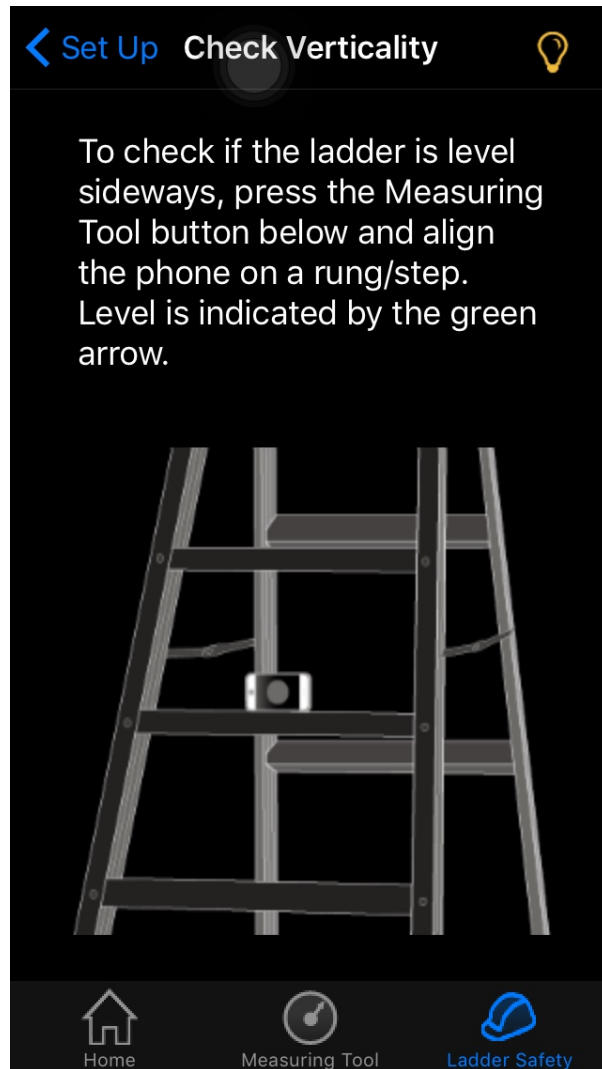

*The text as it appears on the screen.*

# 5: Extension Ladder-Proper Use

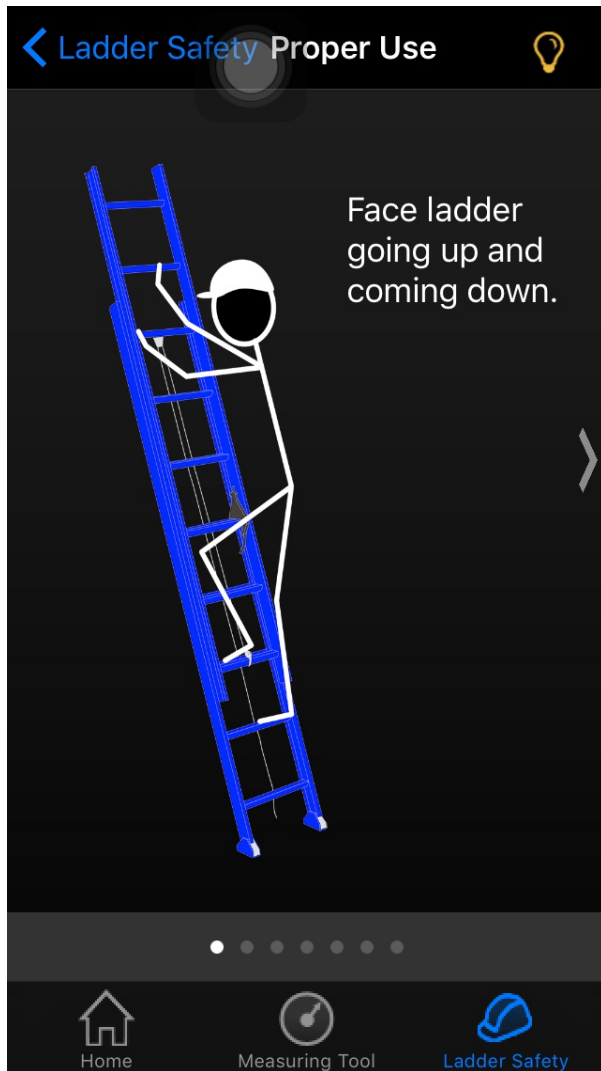

*For all Proper Use screens, the instructions read aloud is the same as the text.*

# 5: Extension Ladder-Proper Use (cont'd)

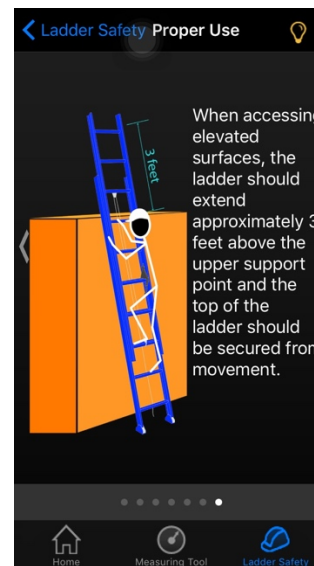
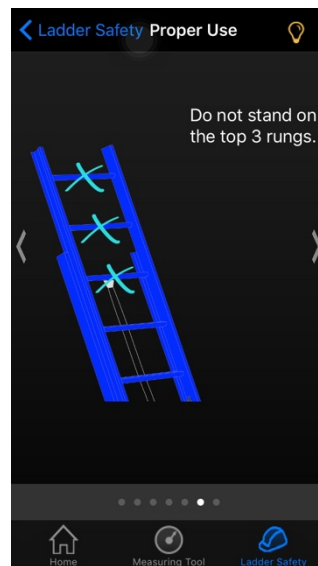
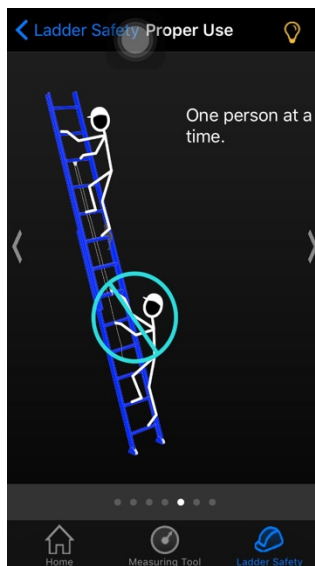
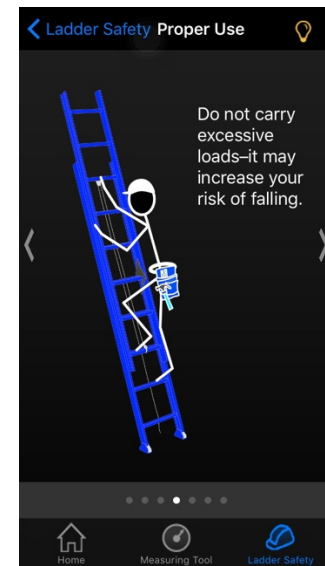
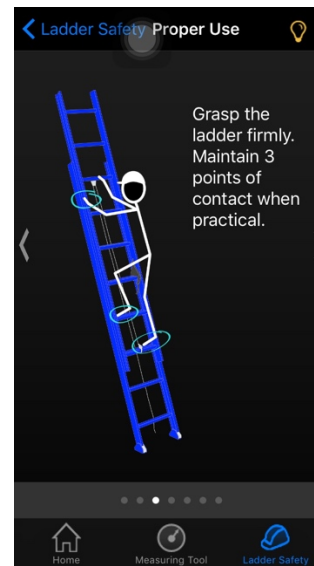
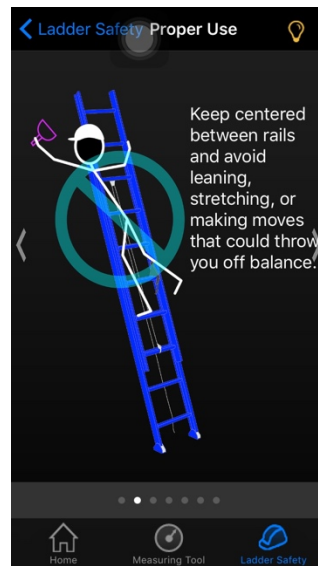
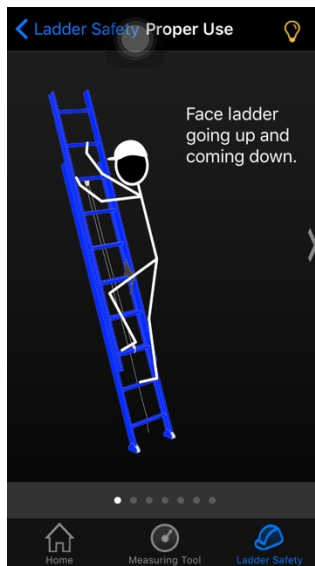

# 5: Step Ladder-Proper Use

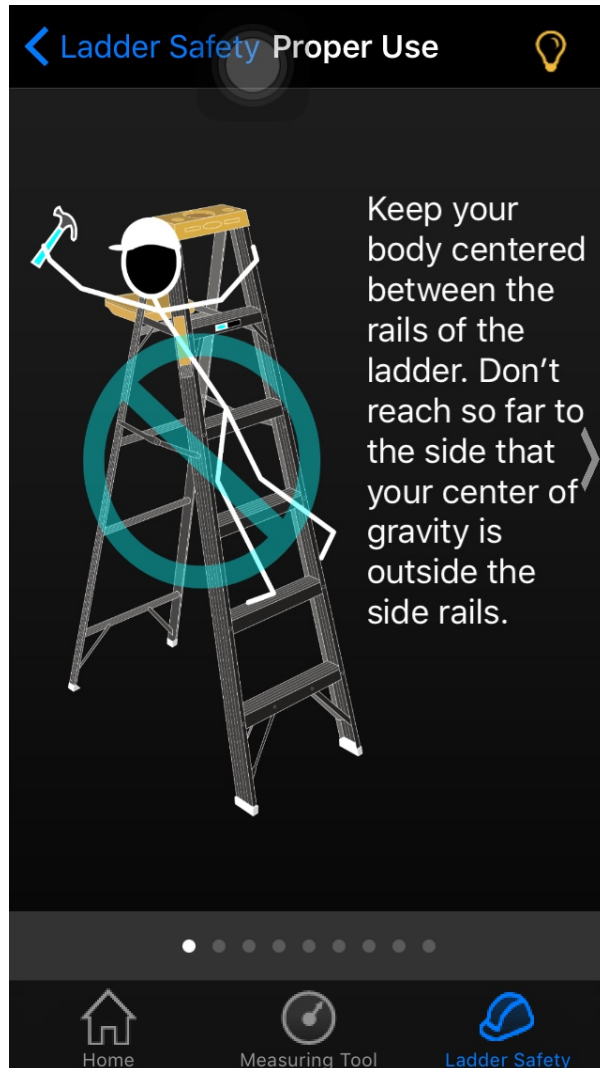

*For all Proper Use screens, the instructions read aloud is the same as the text.*

# 5: Step Ladder-Proper Use (cont'd)

< Ladder Safety Proper Use >



Keep your body centered between the rails of the ladder. Don't reach so far to the side that your center of gravity is outside the side rails.

Home Measuring Tool Ladder Safety

< Ladder Safety Proper Use >



Stand no higher than the second step from the top.

Home Measuring Tool Ladder Safety

< Ladder Safety Proper Use >



Move the ladder only when no one is on it. Don't try to move it while you are on it.

Home Measuring Tool Ladder Safety

< Ladder Safety Proper Use >



One person at a time on the ladder— unless it is designed with steps on both sides.

Home Measuring Tool Ladder Safety

< Ladder Safety Proper Use >



Face the ladder and maintain three points of contact when climbing.

Home Measuring Tool Ladder Safety

< Ladder Safety Proper Use >



Do not carry tools or materials up or down the ladder. Use a tool belt or have them handed up to you.

Home Measuring Tool Ladder Safety

< Ladder Safety Proper Use >



Do not climb the rear section of the ladder unless it is designed with steps.

Home Measuring Tool Ladder Safety

< Ladder Safety Proper Use >



Grip and lean into the ladder to maintain balance.

Home Measuring Tool Ladder Safety

< Ladder Safety Proper Use >



NEVER climb a step ladder in the closed position or leaning against something.

Home Measuring Tool Ladder Safety

# 6: Extension Ladder-Accessories

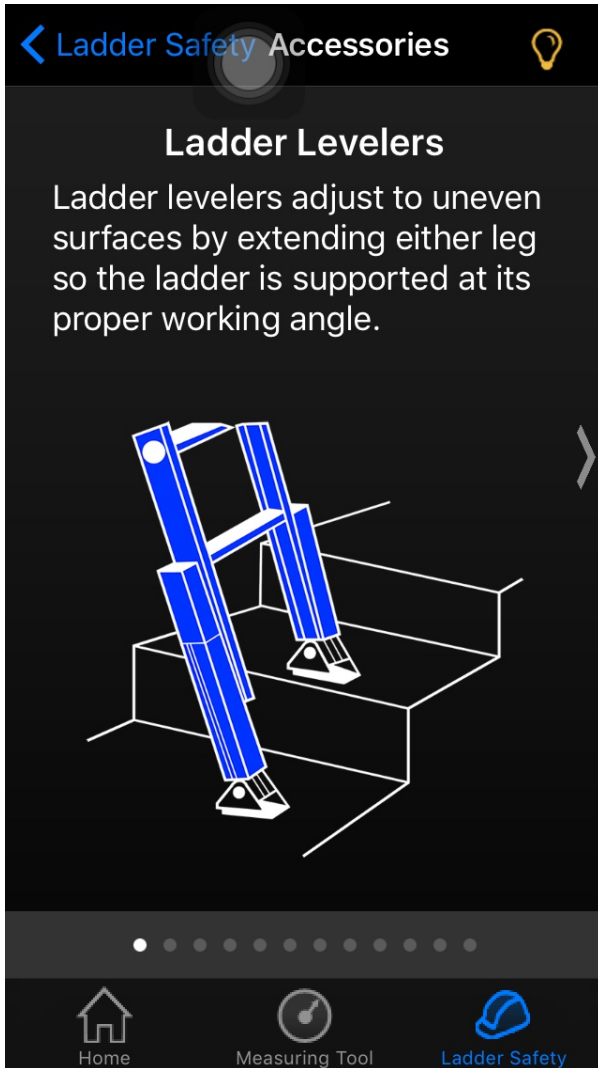

*For all accessories images, the text read aloud will be the same as the caption.*

*For every accessories description, the text read aloud will be the same as the text that is on the screen.*



# 6: Extension Ladder-Accessories (cont'd)

< Ladder Safety Accessories ⓘ

### Ladder Levelers

Ladder levelers adjust to uneven surfaces by extending either leg so the ladder is supported at its proper working angle.

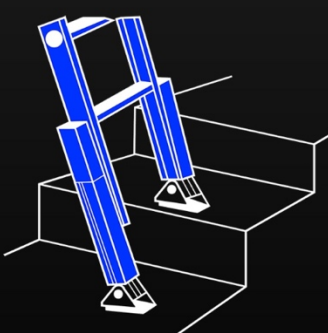

Home Measuring Tool Ladder Safety

< Ladder Safety Accessories ⓘ

### Ladder Feet

Ladder feet may swivel or articulate. Pads on the feet provide slip resistance for the ladder.



Home Measuring Tool Ladder Safety

< Ladder Safety Accessories ⓘ

### Ladder Spurs

Spurs on the feet may help secure the ladder against slipping only on surfaces that they can penetrate.

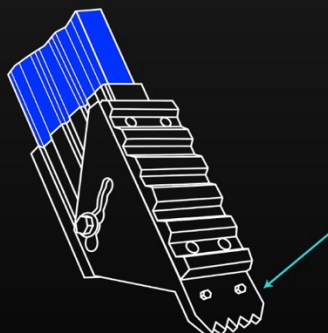

Home Measuring Tool Ladder Safety

< Ladder Safety Accessories ⓘ

### Stabilizer Straps

A stabilizer strap helps prevent ladder slide-out. You should be able to reach it from the ground.

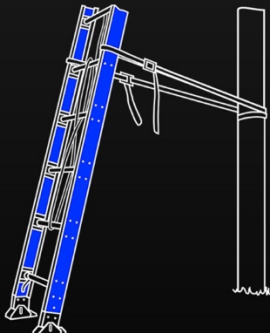

Home Measuring Tool Ladder Safety

# 6: Extension Ladder-Accessories (cont'd)

The image displays four mobile application screens, each with a dark background and white text. Each screen features a back arrow, the title 'Ladder Safety Accessories', and a lightbulb icon. The screens are arranged horizontally and separated by vertical lines. Each screen has a central illustration of a ladder with the specific accessory highlighted in blue. At the bottom of each screen is a navigation bar with three icons: a house for 'Home', a measuring tool for 'Measuring Tool', and a hard hat for 'Ladder Safety'. A progress indicator with seven dots is located above the navigation bar on each screen.

- Side Rail End Covers**  
Side rail end covers help prevent damage to support surfaces.
- Stabilizers and Standoffs**  
Standoffs help to stabilize ladders and prevent damage to support surfaces.
- Gutter Standoffs**  
Gutter standoffs provide support while protecting gutters.
- Corner Standoffs**  
Corner standoffs are used against corners of buildings to help grip the wall and prevent slipping.

# 6: Extension Ladder-Accessories (cont'd)

< Ladder Safety Accessories >

## V-Rungs

V-rungs allow a ladder to be supported against a tree, pole, or building corner.



< >

Home Measuring Tool Ladder Safety

< Ladder Safety Accessories >

## Pole Chain/Strap

A pole chain or strap is used to support a ladder against a pole or a column.

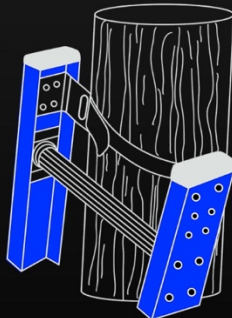

< >

Home Measuring Tool Ladder Safety

< Ladder Safety Accessories >

## Pole Lashes

A pole lash is used with a v-rung, pole chain or pole strap at the top of a ladder when positioned against a pole or column.

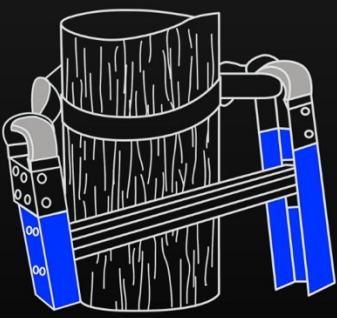

< >

Home Measuring Tool Ladder Safety

< Ladder Safety Accessories >

## Cable (Strand) Hooks

When a ladder is leaned against a cable, cable hooks keep it from disengaging. They are not meant to be the total support for a ladder.

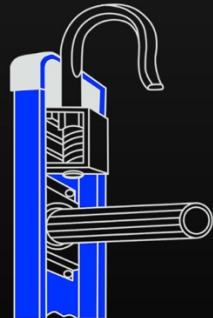

< >

Home Measuring Tool Ladder Safety

# 6: Step Ladder-Accessories

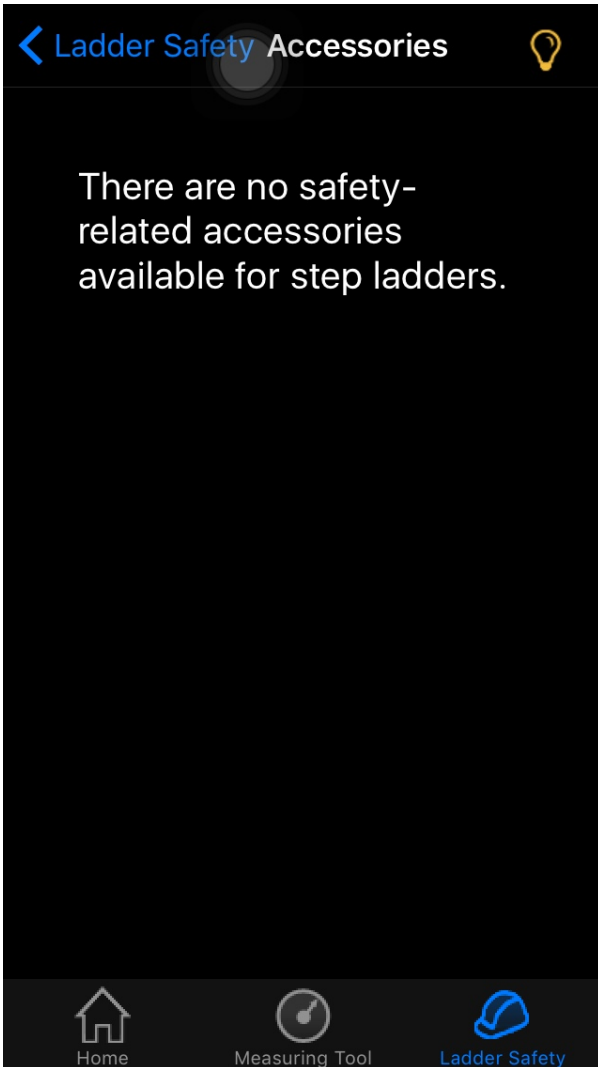

"There are no safety-related accessories available for step ladders."

# End-User License Agreement

END-USER LICENSE AGREEMENT (EULA) for the Division of Safety Research, National Institute for Occupational Safety and Health (NIOSH) Ladder Safety application for iOS and Android mobile devices.

IMPORTANT PLEASE READ THE TERMS AND CONDITIONS OF THIS LICENSE AGREEMENT CAREFULLY BEFORE CONTINUING WITH THIS PROGRAM INSTALL: CDC NIOSH Ladder Safety End-User License Agreement ("EULA") is a legal agreement between you (either an individual or a single entity) and NIOSH for the NIOSH software product(s) identified above which may include associated software components, media, printed materials, and "online" or electronic documentation ("Ladder Safety"). By installing, copying, or otherwise using the Ladder Safety application program, you agree to be bound by the terms of this EULA. This license agreement represents the entire agreement concerning the program between you and NIOSH, (referred to as "licenser"), and it supersedes any prior proposal, representation, or understanding between the parties. If you do not agree to the terms of this EULA, do not install or use the Ladder Safety program.

The Ladder Safety application is protected by copyright laws and international copyright treaties, as well as other intellectual property laws and treaties. The NIOSH Ladder Safety application is licensed, not sold.

## 1. GRANT OF LICENSE.

Ladder Safety is licensed as follows:

### (a) Installation and Use.

CDC NIOSH grants you the right to install and use copies of Ladder Safety on your mobile device running a validly licensed copy of the operating system for which Ladder Safety was designed [e.g., Android, iOS].

## 2. DESCRIPTION OF OTHER RIGHTS AND LIMITATIONS.

(a) Maintenance of Copyright Notices. You must not remove or alter any copyright notices on any and all copies of Ladder Safety.

(b) Distribution. You may not distribute registered copies of Ladder Safety to third parties.

(c) Prohibition on Reverse Engineering, Decompilation, and Disassembly. You may not reverse engineer, decompile, or disassemble Ladder Safety, except and only to the extent that such activity is expressly permitted by applicable law notwithstanding this limitation.

(d) Rental. You may not rent, lease, or lend Ladder Safety.

(e) Support Services. CDC NIOSH may provide you with support services related to Ladder Safety ("Support Services"). Any supplemental software code provided to you as part of the Support Services shall be considered part of Ladder Safety and subject to the terms and conditions of this EULA.

(f) Compliance with Applicable Laws. You must comply with all applicable laws regarding use of Ladder Safety.

# End-User License Agreement (cont'd)

## 3. TERMINATION

Without prejudice to any other rights, NIOSH may terminate this EULA if you fail to comply with the terms and conditions of this EULA. In such event, you must destroy all copies of Ladder Safety in your possession.

## 4. COPYRIGHT

All title, including but not limited to copyrights, in and to Ladder Safety and any copies thereof are owned by NIOSH or its supplier, DSFederal, Inc. All title and intellectual property rights in and to the content which may be accessed through use of Ladder Safety is the property of the respective content owner and may be protected by applicable copyright or other intellectual property laws and treaties. This EULA grants you no rights to use such content. All rights not expressly granted are reserved by NIOSH.

## 5. NO WARRANTIES

NIOSH expressly disclaims any warranty for Ladder Safety. Ladder Safety is provided 'As Is' without any express or implied warranty of any kind, including but not limited to any warranties of merchantability, non-infringement, or fitness of a particular purpose. NIOSH does not warrant or guarantee the ability of this app to function properly with any particular smartphone and/or internal operating system thereto. NIOSH does not warrant or assume responsibility for the accuracy or completeness of any information, text, graphics, links or other items contained within Ladder Safety. NIOSH makes no warranties respecting any harm that may be caused by the transmission of a computer virus, worm, time bomb, logic bomb, or other such computer program. NIOSH further expressly disclaims any warranty or representation to Authorized Users or to any third party.

## 6. LIMITATION OF LIABILITY

In no event shall NIOSH be liable for any damages (including, without limitation, lost profits, business interruption, or lost information) rising out of 'Authorized Users' use of or inability to use Ladder Safety, even if NIOSH has been advised of the possibility of such damages. In no event will NIOSH be liable for loss of data or for indirect, special, incidental, consequential (including lost profit), or other damages based in contract, tort or otherwise. NIOSH shall have no liability with respect to the content of Ladder Safety or any part thereof, including but not limited to errors or omissions contained therein, libel, infringements of rights of publicity, privacy, trademark rights, business interruption, personal injury, loss of privacy, moral rights or the disclosure of confidential information.