

Mine Refuge Chamber Summary

Manufacturers - Volume I

November 30, 2006

Prepared By: The National Technology Transfer Center,
Wheeling Jesuit University

Contract Number: 254-2006-M-19105

Department of Health and Human Services
Centers for Disease Control and Prevention
National Institute for Occupational Safety and Health
Office of Mine Health and Safety



Disclaimer:

The findings and conclusions in this report have not been formally disseminated by the National Institute for Occupational Safety and Health and should not be construed to represent any agency determination or policy.

REPORT OVERVIEW

The National Technology Transfer Center (NTTC) was asked by the National Institute for Occupational Safety and Health (NIOSH) to perform research into regulations related to mine refuges. In addition, NIOSH requested that NTTC determine the manufacturers of mine refuge chambers and provide a summary of the companies and their products. The following report provides a summary of the findings.

The report is divided into two volumes. The first volume (Volume I) is divided into two sections: 1) identified mine refuge regulations and 2) mine refuge manufacturers. A summary is provided at the beginning of each section. Mine refuge-related excerpts from the regulations for each country are provided in individual tabbed sections. The mine refuge manufacturers section is also divided into individual tabbed sections by manufacturer. Information about each company and its products are included. There is an appendix that provides a list of persons contacted during the information gathering portion of this effort. The second volume (Volume II) contains copies of reports and presentations that contain information relating to mine refuges and mine refuge regulations. Each report/presentation is provided in a separate tabbed section.

REGULATIONS

Regulation Overview Summary

A review of international regulations was performed using internet search engines and contact with persons knowledgeable in international mine safety regulations. Excerpts from the regulations for each country investigated as part of this report are provided after this overview. They are organized alphabetically by country.

The results identified three countries (Australia, Canada, and South Africa) and one United States state (West Virginia) with detailed mine refuge regulations. The following provides an overview of the regulations for each of these entities.

- **Australian Regulations**

Australian mine regulations are determined by each state. The following are the states with large mining industries.

 - New South Wales – No regulations were identified for New South Wales.
 - Queensland – Regulations state that type, location, and capabilities of refuges are to be specified in a safety and health management system. Queensland is the principal coal producing state in Australia.
 - Western Australia – Regulations state that each mine must insure that fire refuge chambers and fresh air bases are provided for persons working underground. No details as to the specifications of the chambers were contained within the copy of the regulations reviewed. However, the government also produces a detailed mine refuge chamber guideline that provides specific guidelines for the location for, type of, and capabilities of refuge chambers. These guidelines are not legally binding and are produced for metalliferous mines only. No guidelines for coal mines were identified.
- **Canadian Regulations**

Canadian mine regulations are determined by Province and Territory. With the exception of Newfoundland/Labrador and Prince Edward Island, refuge chamber regulations were identified for all Provinces and Territories. Of the three countries reviewed with detailed mine refuge regulations, Canada's regulations provide the most specification for design, stocking, and location of chambers. All regulations indicate that the refuges need to be sealable, have water/air/communication. Many of the regulations also require construction with non-combustible materials, first aid, required location distances from working faces and explosive/fuel storage, and specific time duration for supplies.
- **South Africa Regulations**

South Africa provides the fewest regulation details on mine refuges and indicates that the type and location of mine refuges is to be determined by a risk assessment and documented in each site-specific health and safety plan.
- **Illinois and West Virginia, United States Regulations**

Illinois and West Virginia regulations specifically address chambers in coal mines. The West Virginia regulations require refuges be sealable, located near

working faces, have communication capabilities, and have a 24 hour supply of water, air, and food. More specific recommendations are included in the West Virginia Mine Safety Task Force report. These recommendations include 48-hour life support, 15 psi overpressure 300 degree Fahrenheit flash temperature resistance, cooling to keep temperature below 95 degrees Fahrenheit, air lock entry, gas monitoring, intrinsically safe power, toilet, periodic inspection, refuge repair materials, and resistance to everyday wear.

The Illinois regulations require mine refuge chambers be built to the specifications approved by the Mining Board. However, Illinois created the Illinois Mine Technology Task Force to review mine safety regulations in the wake of the recent Saco and Aricoma mine disasters. One of the task force's recommendations was for the Illinois mine refuge regulations to incorporate the recommendations made by the West Virginia Task Force. The regulations and Task Force report also include guidelines for barricade materials storage and SCSR caches.

Other countries were identified as having regulations related to refuge chambers. However, they did not provide any detail as to the construction, location, or situation where chambers should be used. They indicated that they should be used where they were determined necessary. A complete summary of the countries identified with mine regulations is included in the attached table titled Mine Refuge, Summary of Regulations by Country.

The following section provides a review of the regulations for each country included as part of this report. The regulations are in alphabetical order by country and separated in individual tabbed sections. Where applicable, excerpts from individual country's or state's regulations are included. Only those portions of the regulations that are relative to refuge chambers are included.

**MINE REFUGE
SUMMARY OF REGULATIONS BY COUNTRY
30 November 2006**

Country	State/Province	Mine Refuge Regulations	Comments
Australia	New South Wales	None Identified	
	Queensland	Yes	Regulations state that type, location, and capabilities of refuges are specified in a safety and health management system.
	Western Australia	Yes	Refuges required, no specifications in regulations but details are in a government published guideline.
Brazil	N/A	None Identified	
Canada	Alberta	Yes	Refuges required, specifications include having water, air, communications, and be sealed off from rest of mine.
	British Columbia	Yes	Refuges required, specifications include water, compressed air, communication, lighting, sealable, mine escape plan, required distance from face and explosive storage.
	Manitoba	Yes	Refuges required, specifications include constructed of non-combustable material, water, compressed air, communication, sealable, mine escape plan, required distance from explosive storage.
	New Brunswick	Yes	Refuges required, specifications include constructed of fire-resistive material, water, compressed air, communication, table and chairs, first aid, sealable, mine escape plan, scaled plan of refuge locations, required distance from explosive storage, protection for 8 hours.
	Newfoundland/Laborador	None Identified	
	Northwest Territories and Nunavut	Yes	Refuges required, specifications include constructed of non-combustable material, water, compressed air, communication, seating, lighting, sealable, mine escape plan, scaled plan of refuge locations, posted directions to refuges, required distance from work areas and explosive storage, protection for 12 hours, Chief Inspector determine number and location of refuges.

**MINE REFUGE
SUMMARY OF REGULATIONS BY COUNTRY
30 November 2006**

Country	State/Province	Mine Refuge Regulations	Comments
Canada	Nova Scotia	Yes	Refuges required, specifications include constructed of non-combustable material, water, compressed air, communication, tables and seating, razors, first aid, blankets, lighting, sealable, mine escape plan, scaled plan of refuge locations, pressure and gas sensors, posted directions to refuges, required distance from work areas, explosive storage, fuel and battery charging stations, protection for 8 hours.
	Ontario	Yes	Refuges required, specifications include constructed of 1-hour fire -resistant material, water, compressed air, communication, sealable, required distance from explosive storage and fuel stations.
	Prince Edward Island	None Identified	
	Quebec	Yes	Refuges required, specifications include constructed of non-combustable 1-hour fire-resistant material, stretcher and blanket, lighting, water, compressed air, communication, sealable, required distance from flammable and explosive stations, minimum height of refuge,
	Saskatchewan	Yes	Refuges required, specifications include constructed of 1-hour fire-resistant material and steel (for portable units), stretcher and blanket, lighting, water, compressed air, communication, first aid, toilet, fire fighting equipment, sealable, mine escape plan and refuge locations marked, required distance from flammable and explosive stations, minimum height of refuge, 36 hour supply, number and location of refuges dictated by chief mines inspector.
	Yukon	Yes	Refuges required if ordered by Chief Mines Safety Officer, water, air, communication, sealable, distance from flammable and explosive stations,
European Union	All member countries	None Identified	Any refuges would need to be approved and meet construction statutes.
Finland	N/A	None Identified	
Germany	N/A	None Identified	
Hungary	N/A	None Identified	
India	N/A	None Identified	
Ireland	N/A	None Identified	
Kosovo	N/A	None Identified	
Northern Ireland	N/A	Yes	Refuges required where necessary. No specifications on refuges.

**MINE REFUGE
SUMMARY OF REGULATIONS BY COUNTRY
30 November 2006**

Country	State/Province	Mine Refuge Regulations	Comments
Poland	N/A	None Identified	
Romania	N/A	None Identified	
South Africa	N/A	Yes	Refuges required, in a non-combustable area where possible, air, water, first aid, sealable, communication, specifics of refuges' construction and purpose included in risk assessment.
United Kingdom	N/A	Yes	Refuges required where necessary. No specifications on refuges.
United States	California	Yes	Required where deemed necessary by CA Division of Industrial Safety, water, compressed air, communication, sealable, two exits, located on mine plans,
	West Virginia	Yes	Refuges required, distance from face, first aid, sealable, food, water, communication, 24 hour supply, Mine Safety Task Force has more specific recommendations including 48-hour life support, 15 psi overpressure and 300°F flash temperature resistance, cooling to keep temperature below 95°F, air lock entry, gas monitoring, intrinsically safe power, toilet, periodic inspection, refuge repair materials, and resistance to everyday wear..

N/A - not applicable

AUSTRALIA

AUSTRALIA

The regulations for mines and mine refuges appear to be under the jurisdiction of the individual territories. The territories with mining operations include New South Wales, Queensland, Western Australia. The following provides discussions and excerpts of refuge related regulations for these territories.

Australia - New South Wales

No regulations relating to mine refuges were identified in New South Wales. The following documents were reviewed as part of this research:

Coal Mine Regulations Act 1982
Occupational Health and Safety Act 2000 No 40
Occupational Health and Safety Regulation 2001
Coal Industry Act 2001
Coal Mine Health and Safety Act 2002 No 129
Mine Health and Safety Act 2004 No 74

Australia - Queensland

The use of mine refuges (also called places of safety and places of refuge in Queensland) is discussed in the Queensland Coal Mining Safety and Health Regulation 2001. However, specific mention to the construction, contents, and location of mine refuges is not discussed. The regulation stipulates that for emergencies, a coal mine must have a safety and health management system that provides for managing emergencies at the mine. Potential emergency situations are identified through a risk assessment which would dictate the presence, type and location of the refuge chambers based on risk factors. References to refuge chambers within the regulation were noted in the following sections:

Queensland Coal Mining Safety and Health Regulation 2001
Coal Mining Safety and Health Act 1999
Reprint 2A, 1 July 2006

PART 4 - Rescue and Communication

Division 3 – Self-escape, aided escape and emergency evacuation **168 Safety and health management system for self-escape**

- (1) An underground mine's safety and health management system must provide for the self-escape of persons from the mine, or a part of the mine, to a place of safety.
- (2) The system must be developed through a risk assessment that includes a consideration of at least the following matters-
 - (a) The location of devices for assisting self-escape;
 - (b) The number of devices, including self-rescuers, to be distributed throughout the mine;
 - (c) Selecting and marking the location for reserve self-rescuers;

- (d) The number and location of changeover stations and refuges;
- (e) Selecting and marking escape routes;
- (f) Communication equipment and ways of using the equipment;
- (g) Training persons in self-escape;
- (h) Fitness of coal mine workers.

(3) The system must provide for a sufficient number of self-rescuers to be placed throughout the mine to enable each person below ground to attempt to escape to the surface if an incident renders the mine, or a part of the mine atmosphere, irrespirable and of poor visibility.

170 Safety and health management system for aided escape

- (1) An underground mine's safety and health management system must provide for the aided escape of persons from the mine, or from a place of refuge, to a place of safety.
- (2) The escape strategies provided by the system must be capable of implementation whenever a person is below ground at the mine.

171 Safety and health management system for emergency evacuation

- (1) An underground mine's safety and health management system must provide for the emergency evacuation of persons from the mine, or a part of the mine, to a place of safety.
- (2) The system must provide for the following-
 - (a) The designation of places of safety where persons may assemble in an emergency;
 - (b) The trigger points for evacuating the mine or a part of it;
 - (c) Periodic exercises to demonstrate the effectiveness of the emergency evacuation system to respond to potential emergencies at the mine.

Division 5 Communication systems

176 Telephonic communications

- (1) The site senior executive must ensure the underground mine's telephonic communication system complies with this section and has an adequate fail safe or backup, power supply for the system.
- (2) The system's electrical components installed underground must be suitable for use in an ERZO, unless the components are installed in a drift or shaft being driven from the surface in material other than coal.
- (3) The system must provide for effective telephonic communication to and from the following places at the mine –
 - (a) Each entrance underground, and on the surface, through which a person may enter into a shaft or other excavation used for ingress to or egress from the mine workings;
 - (b) Each underground battery charging station;
 - (c) Each underground workshop;
 - (d) Each underground crib room;

- (e) A place close to each switchgear used to isolate or control sections of the underground main electricity distribution system;
- (f) A place close to each underground conveyor belt drive head;
- (g) A place close to each underground loading or transfer point on the conveyor belt system;
- (h) Each emergency refuge chamber;
- (i) A place in each inspection district in the mine not otherwise mentioned in paragraphs (a) to (h).

Part 9 Mine Design

Division 1 Mine Plans

285 Fire fighting and mine rescue plan

(1) The site senior executive must ensure the mine has a fire fighting and mine rescue plan, complying with this section, for each of its working seams.

(2) At least 1 hard copy of the plan must be-

- (a) At a scale of 1:2500; and
- (b) Displayed in a location where the plan is readily observable by each underground mine worker at the mine.

(3) The following information shown on the plan must include the following-

- (a) the extent of the mine workings and connections to the surface or workings in other seams;
- (b) the location of the following-
 - (i) water reticulation lines in the mine together with hydrant and valve sites;
 - (ii) fire stations and depots;
 - (iii) ventilation and control devices;
 - (iv) atmospheric monitoring sites, stations and sampling lines;
 - (v) communication lines and telephones;
 - (vi) gas drainage ranges and drainage boreholes;
 - (vii) stored pressure vessels;
- (c) the location and type of refuges;
- (d) the location and contents of caches of self-rescuers;
- (e) the direction of the ventilating air currents;
- (f) Primary escape ways.

The regulations also mention the required use to gas detection equipment in “other places stated in the mines’ principal hazardous management plan” (Part 7 – Gas Monitoring, Division 1 Safety and health management system, 223 Monitoring and sampling mine atmosphere). Presumably, this may include monitoring at refuge stations.

Australia - Western Australia

Regulations and guidelines for mine refuge chambers are described in the following 33 page document:

Western Australia

Mines Safety and Inspection Regulations 1995

Part 4 - General safety requirements

Division 2 - Construction work

4.36. Specific emergency precautions required to be taken for underground mines

(1) This regulation applies to any of the following potential incidents

- (a) A fire;
- (b) An accidental explosion (including a sulphide dust or coal dust explosion);
- (c) A failure of the primary ventilation system;
- (d) Flooding;
- (e) An inrush of mud or tailings;
- (f) An inrush or outburst of gas; or
- (g) The extensive collapse of workings.

(2) The principal employer at, and the manager of, an underground mine must ensure that, so far as is practicable, the following things have been done to ensure the safety of persons working underground in the mine in the event of a potential incident to which this regulation applies

- (a) An alarm system has been installed and a procedure has been established for activating the system;
- (b) A procedure has been established for the prompt notification of rescue and fire fighting teams;
- (c) A procedure has been established for evacuating persons working underground;
- (d) Fire refuge chambers and fresh air bases are provided for persons working underground;
- (e) Provision has been made for the safety of drivers of winding engines at underground shafts;
- (f) All employees are adequately trained and retrained in emergency procedures and the use of emergency equipment and facilities; and
- (g) Emergency drills have been conducted on a regular basis.

Penalty: See regulation 17.1.

Part 9 - Ventilation and control of dust and atmospheric contaminants

9.31. Smoking prohibited in certain workplaces

A person must not smoke in any of the following places

- (a) An enclosed workplace;
- (b) A workplace where
 - (i) the air contains asbestos;
 - (ii) solvents are used; or
 - (iii) flammable vapors are present;
- (c) A package depot or above ground bulk depot;
- (d) A conveyance in a shaft;
- (e) A refuge chamber during an emergency; or
- (f) The underground workings of a coal mine.

Penalty: See regulation 17.1.

Western Australia also produces a guideline on refuge chambers (Guideline – Refuge Chambers in Underground Metalliferous Mines). The guideline “is an explanatory document that provides more information on the requirements of legislation, details good practice, and may explain means of compliance with standards prescribed in the legislation.” The guideline provides ‘key points’ relating to the construction, installation, and location of refuge chambers. Below are excerpts of these ‘key points’:

Guideline – Refuge Chambers in Underground Metalliferous Mines
Department of Industry and Resources
Safety and Health Division
2005

Location of Refuge Chambers

- Site near active workplaces.
- Consider needs of workers and potential hazards they face.
- Maximum distance between workplace and refuge chamber should be based on how far a reasonably fit person can travel at moderate walking pace using 50% of SCSR nominal duration.
- Maximum distance should be no more than 750 m.

Capacity

- Size should recognize potential use by other mine personnel and visitors or
- The mine should implement a system to limit number of personnel in area or
- Both of the above.

Adapting Existing Facilities

- The use of facilities such as lunchrooms as refuge chambers is not recommended – they are better suited as fresh-air bases or associated with such bases.

Safety of Location

- Consider accessibility and susceptibility to hazards.
- Assess susceptibility of ground conditions to seismic activity and other disruptive influences.
- Take into account the existing water make of the mine and potential fluid sources.

Externally Supported Chambers

- Respirable atmosphere should be supplied via a dedicated steel line from an oil-free source on the surface.
- Water should be brought in via an independent, dedicated non-metallic pipe installed in a borehole.
- For breathing air and drinking water directed through normal mine access routes, use steel piping.
- The entry of breathing air into the chamber should be subject to noise suppression measure. Set flow rate to maintain a small overpressure.

Stand-Alone Chambers

- Stand-alone chambers must provide full, independent life support for the occupants, with total disconnection from external services possible.
- Basic requirements under fully isolated circumstances are a respirable atmosphere, electrical power source, supply of drinking water and capability to maintain atmospheric conditions.

Communication

- Telephone linkage is not always adequate for communication, as people may abandon a chamber if the link is compromised.
- Alternative forms of radio coverage include leaky feeder systems, personal emergency devices and hardwired systems.
- Communication systems can be used to control inappropriate use of a chamber.

Internal Equipment

- Consider the restriction of internal space and functionality when assessing the inclusion of equipment.
- Desirable equipment includes a first aid kit, oxy-viva equipment, toilet and table, as well as small items to increase the safety and comfort of occupants.

Duration of Independent Services and Power

- The recommended standard for the minimum duration for which a refuge chamber should be equipped to support life is 36 hours.

Personnel Psychological Issues

- The feeling of being entombed in a refuge chamber can cause enormous stress.
- Adequate lighting, temperature control, deodorizing filters, communication equipment and a small window can all help occupants to cope.

Electrical Equipment

- All electrical installations must conform to Australian Standard AS/NZS 3000:2000.
- External terminations must have an ingress protection rating of IP56.
- All circuit breakers used on the DC side must be selected on the basis of DC current ratings.
- Battery enclosures must conform to Australian Standard AS/NZS 2676.1:1992.
- The provision of 240V AC general power outlets should be strictly controlled in the underground environment.
- The use of braided or armored cable is encouraged when wiring underground installations.

Access and Site Layout

- Consider the need for immediate vehicular access at all times and under all circumstances.
- Use restricting bollards, lighting and signage to assist in ready vehicular access and prevent damage to underground mobile plant.
- Ensure workforce is familiar with effective use of refuge chambers.
- A high-intensity strobe light near the chamber door can expedite the location of the chamber in smoky conditions.
- A siren with collimated sound near the chamber door increases the probability of finding the chamber door in low visibility conditions.

Design and Construction

- Moveable chambers, including equipment mountings, must be robust.
- All access doors must fit properly and seals must always be in good condition.
- A secondary means of egress should be considered.
- A pressure equalization mechanism will maintain the chamber pressure just above that of its surroundings.
- If fitted, windows and retaining structures must be able to withstand external overpressure, particularly from blasting.

- Use a water-based epoxy paint to prevent contamination of the chamber atmosphere.
- Emphasize the hazard posed by flammable materials and ensure their exclusion from refuge chambers.

Maintenance

- Refuge chambers must be ready to provide a safe haven at all times.
- Institute an effective and rigorous inspection and maintenance regime to ensure full functionality.
- Any deficiencies should be reported immediately to the Registered Manager and senior engineer on site.
- Clearly establish who is responsible for the ongoing integrity of the refuge chambers.

BRAZIL

BRAZIL

No regulations relating to underground mine refuge chambers were identified in a search of available online Brazilian regulations. An email was sent to IBRAM – Instituto de Brasileiro de Mineracao (the Brazilian National Mining Association) requesting information on their mining regulations. No response has been received.

CANADA

CANADA

Canadian mine's health and safety regulations are under the jurisdiction of each individual Province and Territory. Each Province has slightly different wording to the requirements of a refuge station. However, all of the regulations require a refuge station to have water, breathable air, effective communication, sealable entryways, stand alone operation capabilities. The following provides refuge-related excerpts from the regulations of each of the Provinces and Territories.

Canada - Alberta

Alberta Regulation 292/95 Occupational Health and Safety Act Mine Safety Regulation

Part 3 Fire Prevention and Emergency Response Underground Coal Mines

Refuge stations

54(1) An employer shall ensure that refuge stations that meet the requirements of this section are provided within the mine, unless exempted by the Director.

(2) A refuge station must

- (a) have water, air and an effective communication system with the surface, and
- (b) be separated from adjoining workings by closeable openings arranged and equipped so that gases can be prevented from entering the refuge station.

Part 8 Underground Mines Contraband Communications

203(1) The employer shall ensure that every underground mine, excepting exploration drivages from the surface not more than 60 meters in length, has a system of voice communication between surface and underground.

(2) Interconnected voice communication stations must be located at

- (a) the top and bottom of shafts and slope outlets and main hoisting and haulage engines,
- (b) main electrical distribution centres, surface and underground,
- (c) main pumping stations,
- (d) refuge stations,

- (e) the drive of every belt conveyor and, where belt conveyors are more than 60 metres long, at the tail-end of the belt conveyor,
 - (f) booster fans,
 - (g) underground garages and repair shops,
 - (h) every mining section as close as practical to the working face and, in the case of a long wall face, close to each end of the face,
 - (i) any other places as directed by the Director, and
 - (j) permanently attended surface stations, which must have a telephonic connection to the public telephone system.
- (3) A separate backup power supply must be provided for the communication system in the event of a power failure.
- (4) Every voice communication station provided pursuant to this section must have an audible alarm that is initiated from the permanently attended surface station and is to be sounded in case of emergency.

Canada - British Columbia

The regulations indicate that refuge shelters are required in mines in cases where they are necessary to protect the workers. The following contains the mining refuge station regulation as found in:

British Columbia Regulation 296/97, Effective April 15, 1998 Workers Compensation Act Occupational Health and Safety Regulation

Part 22 — Underground Workings

Communications

22.35 (1) An effective radio or telephone communication system must be maintained between the surface and underground work areas including refuge and first aid stations and at least every 600 m (2,000 ft).

Refuge stations

22.50 (1) A refuge station must be provided within 500 m (1,640 ft) of the main underground work area, which is

- (a) large enough to accommodate all workers underground,
- (b) supplied with drinking water and compressed air tanks or cylinders,
- (c) equipped with a communication system to the surface,
- (d) capable of being sealed to prevent the entry of gases,
- (e) provided with a plan of the underground working which shows all exits,
- (f) maintained in sanitary condition, and
- (g) equipped with emergency lighting.

(2) When unusual conditions warrant, such as gassy underground workings, additional refuge stations may be required by the Board.

Underground storage of explosives

22.73 (1) Explosives must not be stored underground without the prior approval of the Board.

(2) A magazine or storage container in an underground working must be located in a safe stabilized area where there is no possibility of being struck by a train or mobile equipment, at least 60 m (200 ft) from any shaft, hoist room, portal, refuge station or worker assembly area, transformer vault, or combustible refuse.

Canada - Manitoba

The Workplace Safety and Health Act (C.C.S.M. C. W210)

Operations of Mines Regulations

Regulation 228/94

Registered December 2, 1994

Part 5 Fire Protection – Surface and Underground

Section 44 Emergency exits from Underground

44(2) The employer shall provide and maintain refuge stations constructed in accordance with subsection (3) where

- (a) procedures established under subsection 43(1) require their use;
- (b) the auxiliary route of exit from the mine is not in the fresh ventilating air circuit; or
- (c) the director gives notice to the employer in writing requiring such construction.

Location, Construction and equipment

44(3) Each refuge station provided under subsection (2) shall be

- (a) clearly identified;
- (b) constructed of noncombustible material;
- (c) of sufficient size to accommodate the workers that are required to assemble therein;
- (d) equipped with
 - (i) a supply of compressed air,
 - (ii) a supply of potable water,
 - (iii) a means of communication with surface, and
 - (iv) a means of dealing to prevent the entry of gas; and
- (e) suitably located with respect to working areas.

Regular examination of fire protection system

49(4) At least once in each month an employer shall

- (a) examine for compliance with this regulation all
 - (i) fire protection equipment, fire suppression systems and extinguishing systems,
 - (ii) exit routes from the mine,
 - (iii) refuge stations, and
 - (iv) fire doors;
- (b) record the results of the examinations and the condition of the items referred to in clause (a) and any corrective action or planned;
- (c) make available to the workplace safety and health committee, a copy of the record referred to in clause (b).

Location of explosives stored underground

81(2) An employer shall not permit explosives to be stored underground in a mine at a location

- (a) subject to subsections (4) and (5), within 60 m of a
 - (i) hoist room,
 - (ii) shaft station,
 - (iii) refuge station,
 - (iv) transformer station,
 - (v) fuel storage area,
 - (vi) garage or shop, or
 - (vii) ramp which is the sole access, or
- (b) where a vehicle could collide with the explosive receptacle.

Voice communication system

179 Except during shaft sinking operations, the employer shall install a system to provide voice communication between an attended place on surface and

- (a) the collar of each shaft;
- (b) each landing station in use in a shaft;
- (c) each shaft hoist room;
- (d) each underground refuge station; and
- (e) all other places as might be necessary to provide emergency communications.

Canada - New Brunswick

Regulation 96-105 Under the Occupational Health and Safety Act (O.C. 96-968) November 1, 1996

Part II - Preliminary Requirements

Scaled plans

7 (1) An employer shall ensure that the following scaled plans are made and updated monthly:

- (a) a surface plan showing the boundaries of the property on which the underground mine is located, and all lakes, streams, roads, railways, electric power transmission lines, main pipelines, buildings, shaft openings, adits, open surface working, dumps, tailings disposal sites and magazines in or adjacent to the property;
- (b) underground plans of each level of the mine showing all underground workings, including shafts, tunnels, dams, bulkheads, electrical substations, magazines, fuel storage areas, shop areas, garages, refuge stations and lunch rooms, with the plan for each level shown on a separate drawing;

Part III – General Requirements

Employee training

13 (1) An employer shall ensure that an employee who works underground is adequately trained in the recognition of unsafe ground conditions and the precautions to be taken concerning such ground conditions.

13 (2) An employer shall ensure that an employee who works underground is adequately trained with respect to

- (a) the emergency preparedness plan referred to in section 64,
- (b) the locations of, and routes to, refuge stations, exits, escape ways and other places of safety,
- (c) the basic identification of gases and other hazards that may be associated with the mining operation, and
- (d) the use of protective equipment.

Voice communication system

23 (1) An employer shall ensure that a system is installed and maintained for communicating by voice between persons at an attended place on the surface and

- (a) the collar of the shaft including the collar of an internal shaft,

- (b) each landing station in use in a shaft,
- (c) the hoist room for the shaft including the hoist room for an internal shaft,
- (d) each underground refuge station, and
- (e) each continuous mining machine.

Escapeways, ladderways, and ladders

28 (5) An employer shall ensure that

- (a) an escape plan is included as part of the emergency preparedness plan,
- (b) an escapeway map is posted in refuge stations,
- (c) legible signs showing the way to escapeways are posted in prominent places underground, and
- (d) all employees are instructed in the escape plan and the location of escapeways.

Part V – Emergency Preparedness and Fire Protection

Refuge stations

72 An employer shall establish and maintain underground a sufficient number of refuge stations that

- (a) are constructed of fire resistive material,
- (b) are of sufficient size to contain air that would sustain the life of the number of employees intended to be sheltered for eight hours or are equipped with a means for the supply of compressed air or oxygen that would sustain life of the number of employees intended to be sheltered for eight hours,
- (c) are capable of being sealed to prevent the entry of gases,
- (d) contain tables and benches,
- (e) have an adequate means of voice communication with the surface,
- (f) are equipped with an adequate supply of potable water and suitable emergency toilet facilities,
- (g) are provided with a first aid kit that meets the requirements of subsection 12(3) of the General Regulation - Occupational Health and Safety Act,
- (h) have a posted escape plan and posted emergency procedures, and
- (i) have full instructions posted concerning the conduct of persons within a refuge station during refuge and instructions not to smoke.

73 An employer shall ensure that a refuge station referred to in section 72

- (a) is not used for any purpose other than a lunch room or a storage area for first aid supplies and mine emergency equipment, and
- (b) is checked daily to ensure compliance with the requirements of section 72.

Part VI – Track Haulage and Mobile Equipment

106 (5) An employer shall ensure that track haulage equipment or mobile equipment is not left unattended within thirty-six metres of a refuge station, magazine for explosives, fuelling station or a fuel and oil storage area.

Part VII - Explosives

Prohibitions respecting explosives

128 An employer shall ensure that no explosive is stored within thirty metres of a transformer, fuelling station, fuel and oil storage area, hoist room, access ramp or refuge station or within one hundred metres of an underground shaft station.

Canada - Newfoundland and Labrador

No regulations were reviewed that indicated requirements for refuge stations and/or their construction. The following documents were reviewed for content:

**Consolidated Newfoundland and Labrador Regulation 1145/96
Mines Safety of Workers Regulations under the Mines Act (O.C. 96-477)
2006**

**Consolidated Newfoundland and Labrador Regulation 41/00
Small Scale Operations Regulations under the Mining Act (O.C. 2000-228)
June 22, 2000**

**Consolidated Newfoundland and Labrador Regulation 42/00
Mining Regulations under the Mining Act
June 27, 2000**

Canada - Northwest Territories and Nunavut

Literature indicates that the Northwest Territories regulations are applicable to both the Northwest and Nunavut Territories. The regulations were identified in the following:

**Mine Health and Safety Act
Mine Health and Safety Regulations
R-125-95**

Part 1 – General Design and Operating Procedures Ventilation

Use of Compressed Air

1.58. Compressed air used for ventilation in a raise, sub-drift or refuge station shall be

- (a) continuously supplied to the raise, sub-drift or refuge station through a separate air line;

- (b) controlled only at the beginning of the raise or sub-drift or, in the case of a refuge station, controlled only inside the refuge station;
- (c) noise attenuated at the point of discharge to decrease the noise level to comply with the standards set out in Part IX;
- (d) before discharging, filtered to remove scale, oil and other contaminants; and
- (e) operating when a blast is detonated unless procedures required under section 1.69 are in force. R-008-2003,s.17

Plans

Description of Plans

1.119. The plans required to be kept by section 1.116 shall include

- (f) plans of the workings for emergency egress and mine rescue which shall show
 - (i) the normal routes of egress,
 - (ii) the emergency route of egress,
 - (iii) refuge stations,
 - (iv) normal ventilation flows, control doors, fire doors and fans,
 - (v) power distribution and compressed airlines, and
 - (vi) any hazardous areas such as fuel storage areas. R-008-2003, s.s32.

Examination of Workings

Inspections

1.159. (1) the manager shall prepare a procedure fro the examination of worksites that provides for examination

- (a) of the condition of access routes, haulage roads and travel ways;
- (b) of the suitability and safety of work practices;
- (c) of the general condition of equipment, tools and protective equipment and devices.
- (d) of the use of protective equipment and devices;
- (e) of the condition of refuge stations;
- (f) of the adequacy of ventilation;
- (g) for the presence of hazardous gases and toxic fumes;
- (h) of the security of ground conditions and effectiveness of the support;
- (i) of the emergency arrangements including safe means of egress;
- (j) of the provisions to ensure that work procedures are being properly followed; and
- (k) of any other matter that affects health and safety.

Division 3 – Emergency Procedures

8.34. The manager shall ensure that persons are instructed in the details for the safe evacuations of the mine or a part of the mine and these details shall include

- (a) the identification of the escape routes;
- (b) the location of the refuge stations;
- (c) the proper use of emergency equipment; and
- (d) the nature of the warning system

Division 4 – First Aid

8.47. (1) First aid equipment and supplies shall be provided and maintained at the following places:

- (a) refuge stations;
- (b) shaft stations
- (c) underground and surface workshops;
- (d) a worksite where diamond drilling equipment is used;
- (e) collars;
- (f) control rooms in mills and concentrators; and
- (g) other places where required by an inspector.

Division 5 – Mine Emergencies

Refuge Stations

8.66. The manager shall ensure that a refuge station is located within the closer of the following distances from an active workplace in an underground mine:

- (a) 1 km;
- (b) a distance that takes no more than 15 minutes to travel. R-026-9, s.21; R-008-2003, s.87

8.68. The chief inspectors may direct a manager to provide and maintain refuge stations in as many locations as the chief inspector considers necessary.

8.68. Sections 8.66 and 8.67 do not apply during shaft sinking operations for initial development of a mine.

8.69. Every refuge station shall be

- (a) clearly identified;
- (b) constructed of non combustible material; and
- (c) of sufficient size to accommodate all persons in the vicinity.

8.70. The manager shall submit for acceptance of that chief inspector a plan for the construction and equipping of refuge stations and a copy shall be given to the Committee.

8.71. The manager of a mine shall ensure

(a) that a refuge station is equipped with the following:

- (i) a supply of portable water,
- (ii) a means of communicating with the mine rescue station in an emergency or other situation,
- (iii) general lighting,
- (iv) seating capacity for as many persons as the refuge station is designed to shelter,
- (v) an adequate supply of door sealant to stop air from entering the refuge station,
- (vi) a sealable container that can be used as a toilet,
- (vii) **Repealed, R-008-2003, s.88.**
- (viii) a copy of the procedures for fire fighting underground and a plan showing the ventilation system and routes to the escape exits, both of which are to be posted,
- (ix) at least one first aid kit that meets the requirements of Schedule 1,
- (x) where required,

(A) a source of heat to maintain a minimum temperature of 10° C in the refuge station, or

(B) if the heat referred to in clause (A) may, in the opinion of an inspector cause ground instability, warm suits sufficient to prevent hypothermia for as many persons as the refuge station is designed to shelter, and

- (xi) where the refuge station is underground, an air supply independent of the mine air system and designed to provide a minimum of 12 hours of supply of air for as many persons as the refuge station is designed to shelter;
- (xii) **Repealed, R-008-2003, s.88.**

(b) that the equipment and provisions referred to in paragraph (a) are maintained for immediate use and are examined at least weekly to ensure that the refuge stations is equipped as required and that the equipment is in good working order;

(c) that reproducible maintenance records are kept that set out the results of each examination done under paragraph (b) and the name of the person who did the examination;

- (d) that suitable signs showing the direction of airflow and the routes to refuge stations and escape exits are posted at all junctions leading from worksites; and
- (e) that a code of conduct for persons occupying a refuge station is posted in each refuge station. R-008-2003, s.88.

**Part IX – Working Environment and Industrial Hygiene
Illumination**

Underground Lighting Standards

9.44. The manager shall provide suitable permanent lighting at the following locations and at any other location required by the chief inspector:

- (a) ore pass and waste pass dumps;
- (b) loading pockets;
- (c) shaft stations and conveyance landings;
- (d) garages and fuel bay areas;
- (e) electrical switch rooms;
- (f) underground hoist rooms;
- (g) first aid stations;
- (h) battery charging stations;
- (i) lunchrooms;
- (j) refuge stations;
- (k) service bays;
- (l) conveyor walkways;
- (m) walkways and platforms in both crusher and backfill stations;
- (n) pump stations

R-026-99, s.23.

Part X – Mechanical Equipment

Fuel Pipelines – Underground Mines

Underground Fuel Pipeline

10.106. Where a fuel pipeline is used in an underground mine it shall

- (a) be constructed of minimum standard weight wrought iron or steel pipe or a material having equivalent strength, durability, corrosion and fire resistance;
- (b) have leak proof joints, and if used, sealants or gaskets shall be of a type or design approved by Underwriters Laboratories of Canada for fuel oil service;
- (c) be designed, installed, and used in accordance with the manufacturer's specifications;
- (d) be clearly identified as fuel pipeline;
- (e) be pressure tested before initial use to 345 kPa above atmospheric, or 1.5 times the maximum working pressure, whichever is greater, and

- the pipeline shall retain the pressure for at least two hours after the source of pressure has been removed; and
- (f) not pass through garages, switch rooms, explosive magazines or refuge stations.

Part XIV – Explosives at Mines

Underground Storage

Location of Explosives Storage

14.13. A magazine, day bench, shift box or shift container shall be

- (a) located at least 60 m from a shaft, hoist room , refuge station, transformer vault, electrical substation or fuel storage area;
- (b) provided with conspicuous signs marked “EXPLOSIVES” in letters at least 150 mm in height; and
- (c) provided with conspicuous “NO SMOKING OR OPEN FLAME” signs visible from all approaches and placed not less than 20 m from the magazine, day bench, shift box or shift container.

R-026-99, s.61.

Canada - Nova Scotia

Underground Mining Regulations made under Section 82 of the Occupational Health and Safety Act

S.N.S. 1996, c.7

N.S. Regulation 153/2003

November 8, 2003

Part 1 - Interpretation and Application

Definitions

7 In these regulations,

(bs) “refuge station” means a place designed to provide a place of safety for mine workers during an emergency that meets the requirements of Sections 146 to 149;

Part 2 – Notice, Plan, Report, and Filing Requirements

Mine survey plan

50 An employer must ensure that a surveyor prepares a plan of the mine that includes

- (a) the boundaries of the property on which the mine is located;
- (b) the location of
 - (i) all lakes, streams and other topographical features that might impact on the mine,
 - (ii) roads and railways,

- (iii) electric power transmission lines,
 - (iv) main pipe lines,
 - (v) buildings,
 - (vi) shaft openings,
 - (vii) surface workings,
 - (viii) dumps and waste disposal sites,
 - (ix) magazines in or adjacent to the mine site,
 - (x) entries into and exits from the mine, and any existing workings,
 - (xi) known boundaries of mine deposits and adjacent mine boundaries within 500 m of the proposed workings,
 - (xii) drill holes that might intersect underground workings on the mine site,
 - (xiii) surface facilities, including magazines;
- (c) separate plans of each underground level of the mine showing all major features, including all
- (i) underground workings,
 - (ii) working faces,
 - (iii) shafts,
 - (iv) tunnels,
 - (v) dams, bulkheads, stoppings and barriers,
 - (vi) electrical substations,
 - (vii) magazines,
 - (viii) fuel storage areas,
 - (ix) shop areas,
 - (x) garages,
 - (xi) refuge stations,
 - (xii) lunch rooms,
 - (xiii) room and pillar workings,
 - (xiv) longwall and shortwall workings,
 - (xv) airways,
 - (xvi) escapeways,
 - (xvii) stopes,
 - (xviii) other travelways, and
 - (xix) abandoned areas of the mine;

Ventilation plan

53 (1) An employer must ensure that plans are made of the ventilation system.

(2) The plans of the ventilation system required by subsection (1) must show

- (a) the location and detailed specifications of all fans or air-moving devices;

- (b) the location and detailed specifications of all surface openings;
- (c) the location for the measurement of air in the mine to ensure the proper ventilation at all times;
- (d) the direction, velocity, and volume of the main air currents and of the air at each mine opening;
- (e) the location of all ventilation devices, including main fans, auxiliary fans, booster fans, ventilation doors, airways and crossings, air ducts, brattice, bulkheads, flammable gas drainage pipes and holes, explosion-proof barriers, stoppings, seals, overcasts, undercasts, regulators, doors, and connections with adjacent mines;
- (f) the location of all underground workings and splits, the volume of air entering and leaving each working section, and the volume of return air at each cross-cut in a room and pillar section;
- (g) dimensions of all travelways, tunnels, shafts, vents, or any other device or airway through which ventilating air is moved;
- (h) dimensions of all items listed in clause 50(b);
- (i) separate means of heating the mine ventilating air, if applicable;
- (j) compressed air lines;
- (k) the location of all fire-extinguishing equipment, fire-suppression systems, and fire hydrants;
- (l) [the] location of all non-mobile monitoring and remote sensing equipment;
- (m) transportation systems for
 - (i) persons,
 - (ii) material being mined, and
 - (iii) other materials;
- (n) the location of all first aid stations, first aid supplies and refuge stations;
- (o) the location of all drill holes that might intersect underground workings on the mine site;
- (p) the location of any area designated as a non-gassy zone under Section 188, and the location and type of any non-permissible equipment in the non-gassy zone;
- (q) the location of obstructions, such as ground control arches, that would impede air flow; and
- (r) any methane drainage system.

Part 3 – General Safety Requirements and Work Procedures

Self-rescuers

87 (2) An employer must ensure that a self-rescuer

- (a) provides protection against dust; and
- (b) has a capacity of at least 60 minutes at 1% by volume of carbon monoxide in the air being tested.

(3) If a person might travel to a point that is further distant than 30 minutes traveling by foot from the surface or a refuge station, an employer must ensure that

- (a) the self-rescuer provided in subsection (1) is capable of protecting the user for twice the time it would take the average person to travel by foot from the furthest point traveled to, to the closest of the surface or a refuge station, at 1% by volume of carbon monoxide in the air being tested; or
- (b) if the person has access to a self-contained breathing apparatus at the person's workplace, the combined capacity of the self-contained breathing apparatus is capable of protecting a user for twice the time it would take the average person to travel by foot from the furthest point traveled to, to the closest of the surface or a refuge station;
- (c) caches of self-rescuers are placed at adequate numbers of locations and that
 - (i) each cache is located in an area in which the air will not become contaminated during an emergency, and
 - (ii) each self-rescuer in a cache is capable of providing protection for twice the time it would take the average person to travel by foot to the closest of
 - (A) the next cache,
 - (B) the surface, or
 - (C) a refuge station.

(4) A person must carry an adequate self-rescuer at all times while underground.

Communication system

92 (1) An employer must ensure that a system of devices for communicating by voice is provided, inspected and maintained at a mine.

(2) An employer must establish a surface location that is attended at all times whenever a person is underground by a competent person who is qualified with respect to underground operations.

(3) The communication system required by subsection (1) must enable communication between the competent person at the surface location established under subsection (2) and any person at any

- (a) collar of a shaft, including the collar of an internal shaft, if a shaft conveyance is used;
- (b) landing station in a shaft;

- (c) hoist room for a shaft, including the hoist room for an internal shaft;
- (d) first aid station;
- (e) refuge station;
- (f) maintenance shop, crusher station, lunchroom, conveyor transfer station or additional area designated by the Director.

Signs indicating direction to accesses, stations, hydrants, extinguishers, and self-rescuers

94 An employer must post separate signs in conspicuous places underground that are adequate in number and size indicating the direction to, and the location of

- (a) the primary access and auxiliary access;
- (b) the nearest refuge stations or first-aid stations;
- (c) fire hydrants and other non-portable fire-extinguishers; and
- (d) self-rescuer caches.

Part 4 – Emergency Preparedness and Mine Rescue

Posting of emergency procedures, evacuation procedures and current versions of documents

127 An employer must ensure that a copy of the written instructions required by clause 125(2)(f)(v) describing how to evacuate each workplace, is posted at conspicuous places in each area of the mine to which the instructions apply, including at every shaft station, and in every underground garage or shops, refuge station, first-aid station, and lunchroom.

Warning system

131 (1) An employer must establish, construct, operate, inspect, and maintain a warning system for the underground that is made up of

- (a) an alarm that is adequate to simultaneously warn persons underground of an emergency requiring prompt evacuation of their workplaces, and persons on the surface of the emergency; and
- (b) procedures for
 - (i) activation of the alarm, and
 - (ii) adequate response by persons to the alarm.

(2) An employer must ensure that the alarm required as part of the warning system

- (a) is protected against weather at all times, maintained and available for immediate use; and
- (b) if powered, has a back-up power source, or a system that uses various power sources, for its activation system.

(3) For greater certainty, an alarm required as part of the warning system need not be powered.

(4) An employer must post an explanation of the use of the warning system and a copy of the procedures required under clause (1)(b) that are applicable to a particular area of the mine, at a conspicuous location in that area, including at every shaft station, in underground garage or shop, refuge station, first-aid station, and lunchroom.

Refuge stations required

146 (1) An employer must construct, inspect, and maintain a refuge station every 300 m underground in an active working if a person has to travel more than 500 m to reach

- (a) the mine exit; or
- (b) if a shaft conveyance is used to reach the surface, a shaft station.

(2) Subsection (1) does not apply to those parts of a mine being developed by an adit or slope or during shaft development operations.

Construction and location of refuge stations

147 (1) An employer must ensure that a refuge station can be sealed to prevent the entry of gases and is constructed

- (a) in competent, non-combustible rock;
- (b) if it is a non-portable refuge station in a coal mine, of competent rock that may be coal, if there is an adequate non-combustible sealed barrier between the coal and the occupied space; or
- (c) if it is a portable refuge station, of non-combustible material.

(2) An employer must ensure that a refuge station has adequate drainage for liquid and gaseous waste.

(3) An employer must ensure that all parts of any compressed air lines or water lines supplying the refuge station are made of non-combustible materials.

(4) An employer must ensure that a refuge station is located

- (a) at least 100 m from a magazine, diesel fuel storage area, fuelling station or battery charging station; and
- (b) where reasonably practicable, in intake air.

(5) An employer must ensure that a refuge station has on the outside of the refuge station, an audible signaling device and a sign identifying it as a refuge station.

Air supply in refuge station

148 An employer must ensure that a refuge station has an air supply that is adequate to sustain, for a minimum of 8 hours, the life of the maximum number of mine workers intended to be sheltered there, by ensuring that the refuge station is

- (a) large enough to contain the required air supply; or
- (b) equipped with a means of supplying the required air supply by way of compressed air or oxygen.

Equipment in refuge station

149 An employer must ensure that a refuge station is equipped with

- (a) an oxygen and flammable gas detector;
- (b) a manometer with a scale, mounted on the wall of the refuge station, capable of measuring the pressure difference between the inside and outside of the refuge station;
- (c) an adequate supply of potable water that, if supplied in containers, is exchanged for fresh water at least once a month, or is kept until its expiry date if the supply is sealed and date-stamped by a water supplier.
- (d) adequate toilet facilities, tables and benches;
- (e) an adequate means of voice communication with the surface;
- (f) adequate emergency lighting
- (g) a Number 2 First Aid Kit as defined by the Occupational Health and Safety First Aid Regulations made under the Act;
- (h) a basket-shaped stretcher with restraining straps;
- (i) 2 blankets; and
- (j) razors for shaving facial hair.

Requirement for refuge station procedures

150 An employer must ensure that procedures are prepared for the use of a refuge station during an emergency that include

- (a) instructions for the conduct of persons in the refuge station;
- (b) instructions for entering the refuge station in a manner that protects the health and safety of persons sheltered inside the refuge station; and
- (c) a prohibition on smoking.

Procedures posted at refuge stations

151 An employer must ensure that the procedures required by Section 150 are posted in a conspicuous place on the inside and on the outside of each refuge station.

Permitted uses of refuge stations

152 An employer must ensure that a refuge station is not used for any purpose other than as a lunchroom, office, or storage area for first aid supplies and equipment, for the delivery of first aid, or as a place of refuge during an emergency.

Monthly inspection of refuge stations

153 At least once a month, an employer must ensure that a designated person at the mine inspects, maintains and re-supplies the refuge stations and prepares a report of the inspection and any maintenance performed.

Part 5 – Fire Prevention

Fire-extinguishing equipment

164 (1) An employer must provide adequate fire-extinguishing equipment

- (a) at a working face in a coal mine;
- (b) at the location of an engine or electric motor in a coal mine;
- (c) at the location of a fixed electrical installation underground that is a possible fire hazard;
- (d) in or about a shafthead building or portal house;
- (e) underground at every shaft station, lunchroom, fuelling station, service garage, diesel fuel transfer system, crusher station, pump station, battery charging station, refuge station, tippie and conveyor;
- (f) on mobile equipment underground, which must be a minimum of 2 class “B” fire-extinguishers of a minimum size of 9 kg each if the mobile equipment is used for transporting explosives;
- (g) in accordance with subsection 155(1) at a place underground where a fire is started;
- (h) at a loading face where explosives are kept;
- (i) at a location where hot work is carried out in accordance with Sections 160 and 161; and
- (j) at a place underground where a fire hazard might be created by a means of producing heat or fire and that is designated as a fire hazard area in accordance with clause 157(3)(e);
- (k) at an area underground in which flammable material is kept in a storage area, except an area where blocks of wood used to reinforce supports are stored; and
- (l) in a building or structure on the surface

- (i) that is located above or adjacent to an opening to the underground, or
- (ii) in which a fire might endanger the primary access or an auxiliary access to the underground.

Fire prevention for underground service areas

170 (1) An employer must ensure that an underground service garage, underground fuelling station, underground diesel fuel storage area and underground oil or grease storage area

- (a) is located so that a fire or explosion inside the area would have a minimal effect on any active workings, shafts, magazines, refuge stations or installations, or on the ability of persons to exit the mine;
- (b) if required to have a fire-suppression system under Section 165, is provided with a means for manually activating the fire-suppression system from several locations inside and at least 1 location outside the entrance;
- (c) has a floor constructed of non-combustible materials;
- (d) has a floor without service pits; and
- (e) is provided with means for containing spills of diesel fuel, oil or grease.

Diesel fuel pipelines

173 An employer must ensure that a diesel fuel pipeline serving the underground

- (a) is constructed, operated, inspected, and maintained, in accordance with
 - (i) the manufacturer's specifications, or
 - (ii) if there are no manufacturer's specifications, an engineer's specifications;
- (b) is constructed to minimize the risk of damage and supported so as to avoid dips and sags;
- (c) is constructed of wrought iron, steel pipe or material of equivalent strength, durability, corrosion resistance and fire resistance;
- (d) is certified as adequate by an engineer;
- (e) has leak proof joints, with any sealants or gaskets used conforming to ULC standard ULC/ORD-C107.19-1992, "Secondary Containment of Underground Piping For Flammable and Combustible Liquids";
- (f) is pressure tested before initial use to 345 kPa above atmospheric pressure, or 1.5 times the maximum working pressure, whichever is

- greater, and the pipeline retains the pressure for at least 2 hours after the source of pressure has been removed;
- (g) does not pass through a service garage, switch room, magazine underground, refuge station or first-aid station;
 - (h) is drained empty after each diesel fuel transfer is completed; and
 - (i) is clearly identified as a diesel fuel pipeline.

Part 11 – Blasting Operations and Storage and Handling of Explosives

Where storage of explosives is not permitted

374 (1) An employer must ensure that explosives are not stored

- (a) within 100 m of a
 - (i) transformer,
 - (ii) fuelling station,
 - (iii) fuel oil storage area,
 - (iv) flammable material storage area,
 - (v) shaft station,
 - (vi) hoist room,
 - (vii) primary or auxiliary access,
 - (viii) lunchroom,
 - (ix) blasting area,
 - (x) refuge station, or
 - (xi) first aid station; or
- (b) underground at a mine that ceases development or production for 60 days or more.

Canada – Ontario

**Occupational Health and Safety Act
R.R.O. 1990, Regulation 854
Amended to O. Reg. 630/05**

Mines and Mining Plants

Part III - Access to Workplaces

26. Where the procedure in case of a fire in an underground mine provides for the use of a refuge station for workers, the refuge station shall,

- (a) be constructed with materials having at least a one hour fire-resistance rating;
- (b) be of sufficient size to accommodate the workers to be assembled therein;
- (c) be capable of being sealed to prevent the entry of gases;
- (d) have a means of voice communication with the surface; and

- (e) be equipped with a means for the supply of,
 - (i) compressed air, and
 - (ii) potable water. R.R.O. 1990, Reg. 854, s. 26.

Part V - Haulage

120. (1) A service garage, service bay or fuelling station in an underground mine shall,

- (a) be designed and protected to prevent inadvertent entry of an uncontrolled motor vehicle;
- (b) be located so that in the event of a fire or explosion in the garage, bay or station there will be a minimum effect on working areas of the mine or on underground installations including shafts, magazines, refuge stations, transformer installations and other installations;
- (c) have a concrete floor without service pits in the floor; and
- (d) be equipped with a system to contain spills of oil and grease. O. Reg. 31/04, s. 6.

(2) A service garage or service bay shall be of sufficient size to,

- (a) accommodate the longest and widest vehicle that will use the garage or bay; and
- (b) provide clearance around the vehicles being serviced to permit the safe performance of all work in the garage or bay. O. Reg. 31/04, s. 6.

(2.1) A vehicle shall be serviced where practicable at a service garage or a service bay. O. Reg. 31/04, s. 6.

(2.2) Only one vehicle may be serviced at a service bay at any one time. O. Reg. 31/04, s. 6.

(3) A fuelling station shall be established before a heading has advanced 250 metres from the ramp or shaft unless vehicles can be fuelled at another fuelling station. R.R.O. 1990, Reg. 854, s. 120 (3).

(4) A fuelling station shall be separate from a service garage. R.R.O. 1990, Reg. 854, s. 120 (4).

(5) A vehicle shall be fuelled where practicable at a fuelling station. R.R.O. 1990, Reg. 854, s. 120 (5).

(6) Where a mobile fuelling supply tank is used the tank shall be clearly labeled with "No Smoking" signs. R.R.O. 1990, Reg. 854, s. 120 (6).

(7) Any spillage of oil or fuel shall be taken up at once, deposited in a fireproof receptacle and removed from the mine without undue delay. R.R.O. 1990, Reg. 854, s. 120 (7).

(8) All fuel handling, transfer, storage and dispensing systems in an underground mine shall be designed according to good engineering standards and subjected to a fire safety hazard review before first use. O. Reg. 291/02, s. 5.

(9) The employer, in consultation with the joint health and safety committee or the health and safety representative, if any, shall develop appropriate safeguards and procedures for the safe handling, transfer, storage and dispensing of fuel in an underground mine. O. Reg. 291/02, s. 5.

Part VI - Explosives

126. (1) A magazine, storage container or explosive storage area referred to in subsection 125 (5) that is in an underground mine shall be,

- (a) located at least 60 metres from,
 - (i) the main access into or from a mine,
 - (ii) key mechanical and electrical installations that remain in service during a mine emergency,
 - (iii) areas of refuge or other areas where workers may congregate, and
 - (iv) storage areas for fuels or other potential sources of fire;
- (b) located and designed to protect explosives from vehicle impact or vehicle fires; and
- (c) conspicuously marked by a "DANGER EXPLOSIVES" sign. O. Reg. 272/97, s. 22.

(2) Subclause (1) (a) (i) does not apply during the initial stages of exploration and development of a mine. O. Reg. 272/97, s. 22.

Part X – Mine Hoisting Plant

233. (1) A system for communicating by voice shall be installed and maintained at an underground mine. R.R.O. 1990, Reg. 854, s. 233 (1).

(2) The communication system required by subsection (1) shall permit communication between persons at,

- (a) the collar of the shaft, including the collar of an internal shaft;
- (b) the landing stations in use in a shaft;
- (c) the hoist room for the shaft including the hoist room for an internal shaft;
- (d) an underground refuge station; and
- (e) an attended place on surface. R.R.O. 1990, Reg. 854, s. 233 (2).

Canada - Prince Edward Island

No regulations were reviewed that indicated requirements for refuge stations and/or their construction. The following documents were reviewed for content:

Chapter M-7 Mineral Resources Act

Chapter M-7 Mineral Resources Act – Work Requirements Regulations

Canada - Quebec

Occupational health and safety in mines

Regulation respecting, R.Q. c. S-21, r.19.1

Division II

General

§ 6. First Aid

21. Every mine shall have at least one stretcher and blanket in each refuge station and lunchroom located at the surface.

O.C. 213-93, s. 21.

Division III

Work Environment

§ 5. Emergency exits

71. Except in a place where development work is being carried out, no work may be undertaken underground without having at least 2 separate passages to the surface by which workers may evacuate the mine.

The passages shall enable workers to pass from one level of the mine to another.

Notwithstanding the foregoing, a stope may be operated with only one passage to the surface where the following conditions are satisfied:

- (1) the stope is operated for sampling purposes only;
- (2) no other hoisting, exploration, development or new development work is carried out simultaneously with the operation of the stope;
- (3) a refuge station complying with the standards in sections 127 and 128 is installed less than 10 minutes from the work station;
- (4) the refuge station is equipped with one self-contained breathing apparatus with full face piece and a minimum utilization time of 90 minutes for each worker assigned to the site and to any related haulage;
- (5) the quantity of rock broken is absolutely necessary to render the sample representative of the deposit to be exploited;
- (6) the timbering of the shaft and collar frame is kept wet.

O.C. 213-93, s. 71; O.C. 782-97, s. 7.

Division IV
Quality of the Work Environment

§ 2. Lighting

108. The wearing of a miner's lamp connected to a charged battery is obligatory for any person who is underground.

However, the wearing of such lamp is not required in the locations set forth in section 109, provided that the lamp is within the person's reach.

O.C. 213-93, s. 108; O.C. 782-97, s. 17.

108.1. A miner's lamp used underground shall yield a level of illumination of at least 1500 lux at 1,2 metres (4 ft.) from the light source.

Notwithstanding the foregoing, if the ground to be evaluated is more than 3,6 metres (12 ft.) from the miner's lamp, auxiliary lighting shall also be installed.

O.C. 782-97, s. 18.

108.2. In an underground mine, measures shall be developed to evaluate and maintain miners' lamps.

The results of tests on such lamps shall be entered in the register concerning miners' lamps.

O.C. 782-97, s. 18.

109. Fixed lighting yielding a level of illumination of at least 50 lux shall be installed:

- (1) in each shaft station of a shaft in use;
- (2) in an underground crushing room;
- (3) in a room or area underground containing electrical equipment;
- (4) in an underground refuge station.

O.C. 213-93, s. 109.

Division V
Safety Measures to Prevent Certain Events

§ 4. Refuge stations

126. On any working underground level from which it is not possible to reach a refuge station or the surface within 30 minutes after the alarm system has been activated, a refuge station complying with sections 127 and 128 shall be installed on that level.

On any underground level being developed or any level of an underground mine whose operation begins starting from 1 April 1993 from which it is not possible to reach a refuge station or the surface within 20 minutes after the alarm system has been activated, a refuge complying with sections 127 and 128 shall be installed on that level.

O.C. 213-93, s. 126; Erratum, 1993 G.O. 2, 2603; O.C. 1326-95, s. 24.

127. A refuge station shall

- (1) be constructed with non-combustible materials and have a fire resistance of at least one hour;
- (2) be identified by notices posted approximately 20 metres (65,6 ft.) from the station;
- (3) provide an area of at least 1 square metre (10,8 sq. ft.) per worker needing to seek refuge there;
- (4) be constructed so that it is airtight against smoke when the door is closed;
- (5) be connected to the surface by a means of voice communication;
- (6) have a source of drinking water;
- (7) be connected to a line that has a muffler capable of providing a continuous supply of compressed air from the surface and that has a single air flow control valve located inside the refuge station ;
- (7.1) not be supplied with air by a backup compressor located underground;
- (8) have sealant to seal any leak;
- (9) have a notice board on which are posted a plan of the level, the air supply circuit of the mine and the rescue procedures.

O.C. 213-93, s. 127; O.C. 1326-95, s. 25; O.C. 119-2006, s. 10.

128. A refuge station installed starting from 1 April 1993, in addition to having the characteristics prescribed by section 127, shall:

- (1) be located more than 60 metres (196,9 ft.) from an inflammable substances or explosives magazine;

(2) have a minimum height of 2 metres (6, 6 ft.).

O.C. 213-93, s. 128; Erratum, 1993 G.O. 2, 2603.

§ 5. Extinguishing equipment

129. A shaft station, at the surface or underground, shall have a fire hose equipped with a nozzle and connected to a system that can supply at least 450 liters (99 gallons) of water per minute under a pressure of at least 700 kilopascals (101,5 lbs. per sq. in.).

In a salt mine, a powder extinguishing system having a rated capacity of at least 9 kilograms (20 lbs.) shall be available at each shaft station. Where the shaft house is constructed with combustible materials, the rated capacity of the system at the surface station shall be at least 113 kilograms (250 lbs.).

O.C. 213-93, s. 129; O.C. 1236-98, s. 12.

130. At least one portable extinguisher having a minimum capacity of 4 kilograms (8, 8 lbs.) shall be available in each of the following locations:

- (1) the building covering an opening to the surface of an underground mine;
- (2) the crushing room;
- (3) the pumping room;
- (4) the battery charging station;
- (5) the room or enclosure for underground transformers;
- (6) the garage or workshop;
- (7) the mobile arc welding or welding torch unit;
- (8) the combustible liquids and grease depot;
- (9) the diesel or electric motor;
- (10) the fuel distribution station;
- (11) the vehicle transporting explosives;
- (12) the hoist room;
- (13) the shaft station;
- (14) the lunchroom and the refuge station;
- (15) the combustible material warehouse; and
- (16) the raise climber.

O.C. 213-93, s. 130; O.C. 42-2004, s. 8; O.C. 119-2006, s. 11.

§ 8. Combustible and inflammable substances

159. It is prohibited to bring lubricating oil or grease into a lunchroom or refuge station located underground.

O.C. 213-93, s. 159.

165. A stationary underground fuel tank shall be:

- (1) separated from any travelway and out of reach of motorized vehicles so that they may not strike the tank or pipes connected to it;
- (2) equipped with a device for monitoring the fuel level that makes it impossible to convey fuel from the surface when the tank is full;
- (3) installed so that any fuel that may escape from the tank is held in a sump having a capacity at least equal to that of the tank;
- (4) located at least 60 metres (196,9 ft.) from a shaft, a landing, an explosives magazine, an emergency exit, a transformer room or enclosure, a lunchroom or a refuge station, unless it was installed before 1 April 1993.

O.C. 213-93, s. 165; Erratum, 1993 G.O. 2, 2603.

Division X

Handling and Use of Explosives

§ 2. Storage of explosives

424. An explosives magazine in an underground mine shall be located:

- (1) at least 60 metres (196, 9 ft.) from:
 - (a) a shaft;
 - (b) a hoist room;
 - (c) a working face;
 - (d) a refuge station;
 - (e) a transformer room using an inflammable liquid insulator; the minimum distance shall be 15 metres (49, 2 ft.) for other types of transformers;
 - (f) another explosives magazine;
 - (g) an combustible liquids and grease depot set up from 12 February 2004 containing over 1,000 liters (220 gal.) of combustible liquids and grease ; the minimum distance must be 30 metres (98,4 ft.) for a depot containing between 101 and 1,000 liters (between 22,2 and 220 gal.) of combustible liquids and grease ;
- (2) at least 15 metres (49.2 feet) from a main travelway for off-track motorized vehicles in the case of a magazine installed on or after 23 March 2006;
- (3) such that it is impossible for a vehicle to collide with the explosives; and
- (4) subject to paragraphs 1 and 2, according to the plans and specifications of an engineer in the case of a magazine installed on or after 23 March 2006.

No person may park a motorized vehicle in front of an explosives magazine, except to allow explosives to be transferred without interruption.

O.C. 213-93, s. 424; O.C. 460-2000, s. 30; O.C. 42-2004, s. 20; O.C. 119-2006, s. 31.

Canada - Saskatchewan

The regulations indicate that refuge shelters are required in mines in cases where they are necessary to protect the workers. The following contains the mining refuge station regulation as found in the

The Mines Regulations, 2003 Chapter O-1.1 Reg 2 July 16, 2003

Part VI - Design of Mines Division 2 - Underground Mines

Marking Exits, etc.

46 (3) An employer or contractor must:

- (a) post in conspicuous places underground, and in all refuge stations, a current plan of the mine that shows the workings, the ventilation system and the means of exit; and
- (b) update the plan mentioned in clause (a) at least quarterly.

Part XI - Storage, Transportation and Use of Explosives Division 2 - Storage of Explosives

Location of Underground Storage

229 (2) An employer or contractor must ensure that no explosive or detonator is stored underground in a mine within 60 metres of any:

- (a) shaft station;
- (b) hoist room;
- (c) refuge station;
- (d) electrical substation;
- (e) fuel storage area;
- (f) workshop; or
- (g) lunchroom.

Part XIII – Lighting in Mines

Lighting re underground at a mine

285 At an underground mine, an employer, contractor or owner must provide suitable and adequate stationary lights that are located:

- (a) in every underground shaft station that is in regular use;

- (b) in every underground permanent workshop and garage that is in regular use;
- (c) in every underground hoist room;
- (d) in every underground permanent electrical substation;
- (e) in every underground permanent fixed refuge station;
- (f) in every underground fuel station that is in regular use; and
- (g) at any other place underground where lighting is necessary because of the nature of the work being done or the equipment being used.

Part XVII – Fire Prevention and Control

Division 1 - General

Fire-proof structures required underground

359 Except in the case of portable mine refuge units, an employer or contractor must ensure that every underground building or enclosure constructed on or after the date on which these regulations come into force is:

- (a) constructed of material with at least a one-hour fire resistance rating; and
- (b) located and maintained to reduce any fire hazard to a minimum.

Part XIX – Emergency Response and Mine Rescue re Underground at a Mine

Fire control and emergency plan

383 (1) In this section, “equipment” includes personal protective equipment.

(2) An employer, contractor or owner must:

- (a) take all reasonably practicable steps to prevent the outbreak of fire underground and to provide effective means to protect workers from any fire that may occur; and
- (b) develop and implement a written fire control and emergency response plan that:
 - (i) provides for the safety of all workers in the event of a fire or other emergency underground; and
 - (ii) establishes procedures for workers to follow in the event of a fire or other emergency underground.

(3) A plan developed pursuant to subsection (2) must address the following:

- (a) the types of emergencies that may reasonably occur;
- (b) The minimum number of mine rescue workers that must respond to each incident identified in clause (a), including:

- (i) the qualifications and responsibilities of those mine rescue workers; and
 - (ii) the type of equipment that must be provided to those mine rescue workers;
- (c) the procedure to be used to summon the mine rescue team for duty;
- (d) The emergency procedures to be used in case of fire or other emergency, including:
- (i) a personal accountability system;
 - (ii) if applicable, the use of an emergency hoist;
 - (iii) a procedure to be used if the second egress is unavailable;
 - (iv) excavating endangered workers to the surface or to a refuge station; and
 - (v) the safe recovery of the mine;
- (e) the use of self-rescue apparatus;
- (f) an emergency warning system;
- (g) the design and location of all refuge stations;
- (h) the training of supervisors and workers:
- (i) in the procedures developed pursuant to the plan; and
 - (ii) in the use of equipment necessary to implement the procedures developed pursuant to the plan.

Requirements for emergency voice communication system

386 (1) Except during shaft-sinking operations, an employer or contractor must ensure that an effective emergency voice communication system is installed and maintained.

(2) The voice communication system must permit voice communication between:

- (a) a location on the surface that will be attended by a worker when any worker is underground;
- (b) the collar;
- (c) the landing stations in use in the shaft;
- (d) each hoist room; and
- (e) each underground refuge station.

Part XIX - Emergency Response and Mine Rescue re Underground at a Mine

Primary refuge station

398 (1) An employer or contractor must install, equip and maintain a primary refuge station underground.

(2) An employer or contractor must ensure that each primary refuge station is:

- (a) excavated in solid host material or constructed of steel;
- (b) separated from adjoining workings by fire doors or stoppings that are:
 - (i) designed to prevent noxious fumes from entering the refuge station; and
 - (ii) if reasonably practicable, constructed of materials that have at least a one-hour fire resistance rating;
- (c) Located:
 - (i) if reasonably practicable, in a fresh air circuit;
 - (ii) at least 100 meters away from any fuel station, explosive storage area or other fire hazard; and
 - (iii) as accurately as possible on a map of the surface;
- (d) designed to accommodate the number of workers who may reasonably be expected to use the refuge station;
- (e) clearly marked;
- (f) readily accessible; and
- (g) properly maintained and the area around the entrance is kept free of combustible material.

(3) An employer, contractor or owner must ensure that every primary underground refuge station is equipped with the following:

- (a) at least 36 hours of breathable air for the number of workers who may reasonably be expected to use the refuge station in accordance with the fire control and emergency response plan;
- (b) potable water for the number of workers who may reasonably be expected to use the refuge station in accordance with the fire control and emergency response plan;
- (c) food;
- (d) lights;
- (e) first aid supplies;
- (f) sanitation facilities;
- (g) suitable fire-fighting equipment;
- (h) an effective means of communication with the surface;
- (i) sufficient seating.

Auxiliary refuge stations

399 (1) An employer or contractor must install, equip and maintain auxiliary refuge stations within a reasonable distance of all locations where workers are expected to take refuge in the event of an emergency incident.

(2) An employer or contractor must ensure that each auxiliary refuge station is constructed appropriately and adequately.

(3) An employer or contractor must ensure that every auxiliary refuge station is equipped with the following:

- (a) at least 36 hours of breathable air for the number of workers who may reasonably be expected to use the refuge station in accordance with the fire control and emergency response plan;
- (b) potable water for the number of workers who may reasonably be expected to use the refuge station in accordance with the fire control and emergency response plan;
- (c) An effective means of communication with the surface;
- (d) suitable and appropriate material to maintain the seal around the door of the refuge station.

Additional refuge station

400 An employer or contractor must locate, install, equip and maintain refuge stations, in addition to the refuge stations mentioned in sections 398 and 399, as directed by the chief mines inspector.

Inspection of refuge stations

401 An employer or contractor must:

- (a) ensure that every refuge station, and the equipment in the refuge station, is thoroughly inspected by a competent person at least once a month; and
- (b) Ensure that the results of each inspection conducted pursuant to clause (a) are recorded by the competent person mentioned in clause (a) and countersigned by the employer or contractor.

Use of compressed air in refuge station

402 If a refuge station mentioned in section 398, 399, Or 400 uses compressed air cylinders, the employer or contractor must ensure that the compressed air cylinders are equipped with regulators that provide for the optimum flow of air in the refuge station, taking into account the size of the refuge station and the number of workers who may use it.

The regulations for refuge stations also are covered in the following document:

**Saskatchewan Labour
Occupational Health and Safety Division
Mine Emergency Response Program – Mine Rescue Manual
February, 2001**

Refuge stations

Every underground mine in Saskatchewan must install, equip, operate and maintain such refuge stations as are necessary to protect the workers.

Permanent refuge stations must be provided with food, water, air, first aid supplies and telephone communications to surface. Temporary refuge stations contain more limited supplies, but communication with the surface is also required.

Refuge stations vary in size and should have the volume to provide air for a large number of people without any additional supply of fresh air or oxygen. As a general rule, where there is no source of compressed air, a worker at rest will require 1 cubic metre of air per hour. In the hard rock mines, refuge stations are smaller than in the potash mines but they are supplied with compressed air lines from surface.

In all cases where workers are forced to seek refuge, proper procedures must be employed:

- Workers should carry their lunch and water, as well as available respirators, to the station.
- Communication should be established with the surface.
- The location of the refuge station and the number and names of the workers in it should be reported as soon as possible.
- All nonessential activity in the station must stop to conserve oxygen and reduce CO₂ production.

Once the station is sealed, workers in the station should not emerge until the atmosphere outside the station is checked by mine rescue teams or the "all clear" is given by the authorized authorities.

The types of refuge stations provided in Saskatchewan are as follows:

Permanent type: Usually a stub or drift is cut in the rock and closed at each end with permanent bulkheads and man doors. This type of refuge station is usually strategically located and is large enough to accommodate all the workers in the area.

Portable type: Portable or moveable steel or fiberglass enclosures are usually provided for remote areas in the mine and where travel to a central refuge station is uncertain or unsafe. These units are small enclosures designed for from six to ten workers. They are usually located very close to a work area. This type of refuge station is generally equipped with compressed air or oxygen and a CO₂ absorbent to compensate for the limited air content.

Canada - Yukon

Mine Safety Regulations, Y.O.I.C. 1986B/164

Enabled by the Occupation Health and Safety Act, R.S.Y. 2002, c.159

Fire Control and Emergency Procedures

34.(1) Where the Chief Mines Safety Officer deems it necessary or advisable for the protection of workers employed underground, the officer may order refuge stations to be provided and maintained at such places within the mine as directed.

(2) Every refuge station shall have water, air, and telephone connections to the surface and be separated from adjoining workings by closeable openings so arranged and equipped that gases can be prevented from entering the refuge station.

Underground Mining

Communication

132.(1) A system for communicating by voice shall be installed and maintained at an underground mine at the discretion of the Chief Mines Safety Officer.

(2) The communication system required by (1) shall permit communication between persons at

- (a) the collar of the shaft, including the collar of an internal shaft,
- (b) the landing stations in use in a shaft,
- (c) the hoist room for the shaft including the hoist room for an internal shaft
- (d) an underground refuge station, and
- (e) an attended place on surface.

Underground Haulage

154. (1) A service garage or fueling station in an underground mine

- (a) be designed and protected to prevent inadvertent entry of an uncontrolled motor vehicle,

- (b) be located so that in the event of a fire or explosion in the garage or station there will be a minimum effect on working areas of the mine or on underground installations including shafts, magazines, refuge stations, transformer installations, and other installations,
- (c) have a concrete floor without service pits in the floor, and
- (d) be equipped with a system to contain spills or oil and grease.

Underground Blasting

180. A magazine or storage container in an underground mine shall be,

- (a) located at least 60 m (200 ft.) from
 - (i) shaft
 - (ii) hoist room,
 - (iii) main access ramp,
 - (iv) refuge station, or
 - (v) transformer vault;
- (b) conspicuously marked by a "DANGER- EXPLOSIVES" sign or signs.

EUROPEAN NATION

EUROPEAN UNION REGULATIONS

All of the countries that are members of the European Union are required to meet the minimum requirements and regulations set forth in EU Council Directive 92/104/EEC of 3 December 1992. This directive covers the "minimum requirements for improving the safety and health protection of workers in the surface and underground mineral-extracting industries" (twelfth individual Directive within the meaning of Article 16 (1) of Directive 89/391/EEC).

A review of this directive identified no specific reference to the requirement of refuge bays in underground mines.

Under Section II, Article 3, General Obligations 2, a 'safety and health document' needs to be created that demonstrates "the risks to which workers at the workplace are exposed have been determined and assessed ... the design, use and maintenance of the workplace and of the equipment are safe." The risk assessment required may indicate the need for refuge bays in certain circumstances.

Section II, Article 5 covers "Escape and rescue facilities" and is worded as follows: "The employer shall provide and maintain appropriate means of escape and rescue in order to ensure that workers have adequate opportunities for leaving the workplaces promptly and safely in the event of danger." The reference to appropriate means of escape may include the need for refuge bays if specified in the risk assessment.

In addition to the above requirements, all equipment that has an electric component needs to meet European standards and be certified. Certified equipment bears the mark "CE". It is expected that any self-contained mine refuge with a need for electrical supply (for temperature control, CO₂ scrubbing, lighting, and other power needs) would have to be approved and marked "CE".

Additionally, an email was sent to the Hungarian delegate to the European Union Parliament requesting information on mining regulations for Hungary and the European Union. He was emailed because he had attended a recent European mine health and safety conference. No response has been received.

FINLAND

FINLAND

An email was sent to the information office of the Safety Technology Authority of Finland (TUKES) requesting information on mining refuge regulations for Finland. Anne-Mari Lahde, Chief Engineer for Process Safety, TUKES, replied to my inquiry. The following is an excerpt from her response:

“In Finland our mine regulations are over 40 years old. In these current regulations there is no mention of compulsory mine refuges. In practice, however, the operators have built refuges for every underground mine. It has also been our strong recommendation.

We are now reforming our mine legislation, and probably this requirement will be in the revised legislation, which should be ready in 2008.”

GERMANY

GERMANY

No regulations relating to underground mine refuge chambers were identified in a search of available online German documents.

HUNGARY

HUNGARY

No regulations relating to underground mine refuge chambers were identified in a search of available online Hungarian regulations. An email was sent to the head of the division of Regulatory and International Affairs, Hungarian Geological Survey requesting information on their mining regulations. This message was forwarded to the Hungarian Office for Mining. No response has been received.

Additionally, an email was sent to the Hungarian delegate to the European Union Parliament requesting information on mining regulations for Hungary and the European Union. He was emailed because he had attended a recent European mine health and safety conference. No response has been received.

INDIA

INDIA

No regulations related to refuge chambers were identified. The following three documents were reviewed:

**The Mines Act 1952
(Act No. 35 of 1952)
(As modified up to 1983)**

**The Mines Rules, 1955
Ministry of Labour
2 July 1955**

**The Mines Rescue Rules, 1985
Ministry of Labour
29 March 1985**

An additional report was reviewed called The Australia/India Mine Safety Training Project. The project was a review of India health and safety by Australia and the report recommends the design and use of refuge bays as a way of improving survivability in the event of an underground emergency. The following is an excerpt from the Results, Findings and Recommendations section:

“The establishment of a refuge station underground would go a long way towards solving this problem [improvement of emergency preparedness and response]. This station also needs to be equipped with a water supply and fail-safe communications with the surface, ideally through a borehole.

Rope guidelines should also be installed from the working faces to the refuge chamber to enable the miners to reach this safe haven. This type of system has been used with some success in Australia and is more effective than many high-tech electronic guidance devices.” (p.17)

IRELAND

IRELAND

No regulations relating to underground mine refuge chambers were identified in a search of available online Irish regulations. The following document was reviewed:

Mines and Quarries Act, 1965
Irish Statute Book

KOSOVO

KOSOVO

No regulations relating to underground mine refuge chambers were identified in a search of available online Romanian regulations. An email was sent to The Department of Environmental Protection requesting information on their mining regulations. A response indicated that the law on Mines and Minerals has been passed by the government. This law was not able to be reviewed online.

Regulations in Kosovo are created by the United Nations Interim Administration Mission (UNMIK). The UNMIK Regulations on Mines and Minerals in Kosovo (Regulation 2005/3) was searched for terms that included safety, haven, escape, safe, refuge, places of safety, emergency, egress, exit. None of the search terms identified were associated to mine refuge regulations.

The UNMIK Occupational Safety, Health and the Working Environment (regulation number 2003/33) was reviewed. No mention of refuge stations was identified. The regulation states in Section 6 – Special fields of the occupational safety, health and working environment that “Specific occupational branches and risks shall be regulated separately by secondary legislation of the basis of this Law.”

It also states (Section 11 – Electrical Hazards) that “All electrical equipment shall have the label on which all their characteristics are marked with CE symbol. Electrical installations should be done in accordance with European standards (EN). This standard would apply to any portable or in situ constructed mine refuge.

N IRELAND

NORTHERN IRELAND

Safe havens (mine refuges) are mentioned in Northern Ireland regulations. Their presence is not required but they are to be provided 'where necessary.' However, specific design, content, installation, and location descriptions are not provided in the regulation reviewed. The following provides the relevant excerpts:

Escape and Rescue from Mines Regulations (Northern Ireland) 1999
Statutory Rules of Northern Ireland
Statutory Rule 1999 No. 173
10 May 1999

Part I – Interpretation and General Interpretation

2. In these Regulations -

"safe haven" means a place below ground at a mine which is provided with facilities such that persons may wait there in safety to be rescued;

Part II – Escape and Emergency Organization Arrangements for escape

10. - (1) The owner of every mine shall provide –

- (a) where necessary, suitable self-rescuers for all persons going below ground at the mine; and
- (b) where necessary, safe havens or facilities for the exchange and recharge of self-rescuers.

The following regulation also was reviewed for content relating to mine refuges:

Mines (Safety of Exit) Regulations (Northern Ireland) 1998
Statutory Rules of Northern Ireland
Statutory Rule 1998 No. 375
10 May 1998

No regulations relating to mine refuges were identified in this document.

POLAND

POLAND

No regulations relating to underground mine refuge chambers were identified in a search of available online Polish documents. Mr. Wojciech Magiera, the Director of the Mining Department for the Polish State Mining Authority was emailed requesting information. Mr. Magiera provided the following response:

“Mine refuges (sealable premises) are not used in Polish underground coal, copper ore, salt etc. mining. There are no requirements according to the mine refuges in Polish safe and health regulations. According to Polish regulations, in case of the evacuation’s time exceeds the time of protection’s effect of mining rescue equipment, the rescue equipment replacement’s stations are organised. Mine refuges were tested in Polish mining but have not been adopted in practice.”

ROMANIA

ROMANIA

No regulations relating to underground mine refuge chambers were identified in a search of available online Romanian regulations. An email was sent to The National Institute for Safety in Mines and Explosion Protection (INSEMEX PETROSANI) requesting information on their mining regulations. No response has been received.

An email was sent to the Romanian National Hard Coal Company requesting information on mining regulations for Romania. He was emailed because he had attended a recent European mine health and safety conference. No response has been received.

SOUTH AFRICA

SOUTH AFRICA

The South Africa mine regulations under the Mine Health and Safety Act (No. 29 of 1996) mandate the installation of mine refuges in South African mines. The design and construction of refuge bays is to be prepared and included in an individual mine's Code of Practice (COP) so specifications for refuge chambers are not detailed in the regulations.

Actual wording of the regulations under Act No. 29 relating to refuge chambers was not found through the sources reviewed. However, the references to the regulation and guidelines to refuge specifications (construction, location, features) are summarized in documents prepared by the Safety in Mines Research Advisory Committee (SIMRAC) and the Mining Qualifications Authority (MQA). SIMRAC is a government mandated advisory committee that advises the South Africa Department of Minerals and Energy (DME) on setting regulations and MQA is a governmental entity that creates training and instruction in mine safety. The excerpts relating to refuge bay design is included below:

**SIMRAC Report COL 115 - Assessment of Refuge Bay Designs in Collieries
Safety in Mines Research Advisory Committee (SIMRAC)
J W Oberholzer, 1997**

4 Refuge Bays in South African Collieries 4.1 Requirements of Refuge Bays

The establishment, maintenance and function of refuge bays are defined in the Minerals Act and Regulations:

'refuge bay shall mean a place in the underground workings which is inaccessible to air containing noxious smoke, fumes or gases and which shall be having regard to the maximum number of persons likely to be present in the area served by the refuge bay-

- (i) Equipped with means for the supply of respirable air unless conditions are such that this is not required,
- (ii) Equipped with a sufficient supply of potable water,
- (iii) Equipped with first aid equipment,
- (iv) Of sufficient size to accommodate that number of persons,
- (v) Equipped with a means of communicating verbally to surface,
- (vi) Situated where possible in an area free of combustible material.'

Oberholzer also indicates that "although not defined as such in the act it can be assumed that damage to the structure should be contained to the limit that there should not be leaks of sufficient size and number that would allow an inflow of gases into the refuge chamber itself. It, therefore, stands to reason that the construction should also be such that the support systems like water, air and communications should still be available and working after the explosion." (Oberholzer, p.23)

A second SIMRAC document discusses best practices for emergency response, including escape and rescue:

SIMRAC - COL 605

A Manual for Best Practice for Emergency Response Procedures Part 2 The Management of Inrushes, Fires, Explosions and Other Emergencies February 2000

“2.5 Refuge bays

The mine should be equipped so that every person working or traveling underground may reach a refuge bay or other place of safety within the duration of his SCSR even when used under adverse conditions (i.e. zero visibility). This therefore includes not only production sections but also workshops, stores and all personnel (including contractors) working or traveling outbye of the sections.

It is suggested that this distance be experimentally determined for each mine by selecting a number of test subjects from a spread of the worker population (including some new employees) and conducting trials with blindfolded subjects and ascertain how far they could travel (including time required to locate the life line) within a percentage (60-70 percent) of the known duration of the particular SCSR in use on the mine. This figure would then give a good indication for maximum refuge bay spacing on a particular mine. It must be borne in mind that these escapes will be made in the aftermath of an explosion or during a fire and basing the spacing on anything approaching normal conditions would not be best practice.” (p. 4 – 5)

“The CoP [Code of Practice] for Escape and Rescue should clearly specify the siting, construction requirements and equipping of refuge bays of all types and the procedures to be followed in an emergency.

Formal colliery refuge bays should be of adequate size to cater for the anticipated number of persons expected to occupy it, plus a 20 per cent factor of safety and the size should be based on 1,0 m² per person. Walls should be capable of withstanding a pressure differential of 140 kPa. Steel, self-closing airlock doors and suitable bleeder pipe must be installed. In addition, they are required to comply with Regulation 24.20.2.2.

Colliery refuge bays can either be ventilated by a borehole from surface or by oxygen generators or cylinders of compressed air, whichever is appropriate in the prevailing circumstances.

It is essential that the condition and equipment of all refuge bays be checked and logged regularly by a person, who is accountable, appointed in writing.

All refuge bays or places of safety should have suitable instructions posted up. These should be in appropriate languages and pictorially, to cater for illiterates.

Where refuge bays are ventilated from surface the mine should have two or more systems to enable fresh air to be pumped down the borehole and have arrangements with local mines to draw on additional units that can be immediately connected on arrival. i.e. power supply, connections etc. are compatible.

Finding the borehole sites, particularly at night in an emergency, can be problematic. Therefore, it is recommended that the borehole locations are not only clear marked on plans but, are clearly signposted on surface, along with the routes to them.” (p. 5)

Additional information relating to requirements of refuge bays can be found in a document prepared by the Mine Qualifications Authority (MQA), a governmental entity that creates training and instruction in mine safety. The excerpt is as follows:

**Examiners Guide for the Assessment and Certification of Blasting Certificate Holders for Scheduled Mines
Mining Qualifications Authority (MQA)**

“Refuge Chambers must be provided at locations directed by the manager in conjunction with the ventilation department. The location of Refuge Chambers is dependent on the risk, ventilation design, geometry of mining operations and measures put in place to protect workers in the event of any emergency requiring their use. Approved guidelines should be used together with risk assessments (which should include aspects of poor visibility) to decide on the location of Refuge Chambers.” (p. 87)

The MQA report also includes the following Refuge Chamber requirements:

- Posting approved procedures for treatment of “gassing,” “heat stroke,” “heat exhaustion,” drowning,” and “electric shock.” in a conspicuous place within the chamber (p. 58);
- Clear posting of signage that shows the refuge chambers location (p. 86);
- Telephone numbers of the emergency control centre and fire detection room should be displayed within the chamber. (p. 116)

South African coal mines are typically shallow, allowing for the typical installation of refuge chambers with boreholes to the surface. This allows for air, water, food, and communication to be provided to the stranded miners (DJF Consulting Limited, 2004, Refuge Stations/Bays & Safe Havens in Underground Coal Mining).

UNITED KINGDOM

UNITED KINGDOM

No regulations requiring mine refuges were identified. However, there was reference to mine refuges being required where necessary to facilitate escape. The regulations did not indicate specific requirements for the refuges other than indicating that it is a facility that is provided so that persons can wait there to be rescued.

Statutory Instrument 1995 No. 2870

The Escape and Rescue from Mines Regulations 1995

Definitions

"safe haven" means a place below ground at a mine which is provided with facilities such that persons may wait there in safety to be rescued;

Arrangements for escape

10.—(1) The owner of every mine shall provide-

- (a) where necessary suitable self-rescuers for all persons going below ground at the mine; and
- (b) where necessary safe havens or facilities for the exchange and recharge of self-rescuers.

1

2

3

UNITED STATES

UNITED STATES

Mine refuge regulations were identified for California and West Virginia.

California – United States

The California mine regulations under the California Code of Regulations mandate the installation of mine refuges when it is deemed necessary by the California Division of Industrial Safety.

California Code of Regulations, Title 8 Division 1. Department of Industrial Relations Chapter 4. Division of Industrial Safety

Subchapter 17. Mine Safety Orders

Article 26. Emergency Plan

§7076. (4-50) (11-53). Fire and Safety Diagram.

(a) A diagram of the mine shall be provided showing the location of:

- (1) Principal levels
- (2) Shafts
- (3) Tunnels
- (4) Manways
- (5) Escape routes
- (6) Fire doors
- (7) Fire extinguisher
- (8) Water and air lines available for fighting fire
- (9) Telephones
- (10) Refuge stations
- (11) Ventilation doors
- (12) Direction of air flow

(b) The diagram shall be brought up to date at least once every six months. It need not show boundary lines, outlines of ore bodies, or other details not essential for the safety of employees.

(c) Easily legible copies of the fire and safety diagram shall be kept posted on the surface near the mine entrance most frequently used by the men and at every working station in the mine.

Article 27. Escapeways and Refuge Stations

§7081. Refuge Stations.

(a) When the Division deems it necessary for the protection of employees, it may require that refuge stations be provided and maintained at such places within the mine as the Division may direct.

(b) Where feasible, the refuge station shall be located where it has two exits to the surface.

(c) (11-52d) The refuge station shall be provided with a water line, compressed air line, and telephone connection through each exit to the surface. The air lines and water lines shall be equipped with suitable valves which can be readily operated without the use of a tool.

(d) (11-52a c) Each refuge station shall be provided with fire doors so it can be isolated from other parts of the mine.

(e) (11-52b) Refuge chambers shall be large enough to accommodate readily the normal number of men in the particular area of the mine.

(f) (11-54) Telephone or other voice communication shall be provided between the surface and refuge chambers and such systems shall be independent of the mine power supply.

Illinois – United States

Two documents were identified related to Illinois coal mining regulations: 1) State of Illinois 94th General Assembly Public Act amending the Coal Mining Act, and 2) Recommendations from the Illinois Mine Technology Task Force. Both documents provide recommendations on: 1) self-contained self-rescue (SCSR) cache location and contents, 2) requirements for a skid containing barricading materials, and 3) refuge chambers. SCSR cache recommendations are included due to their similarity to a fresh air base and refuge bases. Excerpts from both documents are provided below.

State of Illinois, 94th General Assembly

Public Act 094-1041

SBO929 Enrolled, LRB094 04554 LJB 34583 b

Section 99. Effective date. This Act takes effect upon becoming law.

Effective Date: 7/24/2006

Be it enacted by the People of the State of Illinois represented in the General Assembly:

Section 5. The Coal Mining Act is amended by changing Sections 11.01, 19.11, 22.18, and 38.3 and the heading of Article 29 and by adding Sections 1.19, 1.20, 1.21, 1.22, 1.23, 1.24, 10.08, 11.07, 11.08, 11.09, 11.10, 11.11, 13.16, 13.17, 13.18, 29.05, 29.06, 29.07, 38.4, and 38.5 as follows:

(225 ILCS 705/1.23 new)

Sec. 1.23. "Rescue chamber" means a chamber within a mine that is properly constructed to protect against potential hazards in case of any emergency and is properly equipped with first aid materials, an oxygen-generating device capable of providing a minimum of 48 hours of oxygen for at least 10 people, and proper accommodations for persons underground awaiting rescue, as determined by the Mining Board.

(225 ILCS 705/124 new)

Sec. 1.24. "Cache" means a storage facility within a mine that is properly constructed to store SCSR devices in case of an emergency for use by persons underground in emergency situations, as determined by the Mining Board.

(225 ILCS 705/11.08 new)

Sec. 11.08. Self-contained self-rescuer (SCSR devices; caches; strobe lights; luminescent signs.

(a) An operator must require each person underground to carry a SCSR device on his or her person or, alternatively, a SCSR device must be kept within 25 feet of the person underground or may be kept more than 25 feet from the person underground if done according to a plan approved by the Mining Board.

(b) An operator must provide for each person who is underground at least one SCSR device, in addition to the device required under subsection (a), that provides protection for a period of one hour or longer, to cover all persons in the mine. This additional SCSR device must be kept within 25 feet of the person underground or may be kept more than 25 feet from the person underground if done according to a plan approved by the Mining Board.

(c) If a mantrip or mobile equipment is used to enter or exit the mine, additional SCSR devices, each of which must provide protection for a period of one hour or longer, must be available for all persons who use such transportation from portal to portal.

(d) If the SCSR devices required under subsections (a), (b), and (c) are not adequate to provide enough oxygen for all persons to safely evacuate the mine under mine emergency conditions, the mine operator must provide additional SCSR devices in the primary and alternate escapeways to ensure safe evacuation for all persons underground through both primary and alternate escapeways. The Mining Board must determine the time needed for safe evacuation under emergency conditions from each of those locations at 1,000 foot intervals. The mine operator must submit a SCSR storage plan to the Mining Board for approval. The mine operator must include in the SCSR storage plan the location, quantity, and type of additional SCSR devices, each of which must provide protection for a period of one hour or longer, that are stored in the primary and alternate escapeways. The SCSR storage plan must also show how each storage location in the primary and alternate escapeways was determined. The Mining Board must require the mine operator to demonstrate that the location, quantity, and type of the additional SCSRs provide protection to all persons to safely evacuate the mine. The SCSR storage plan must be kept current by the mine operator and made available for inspection by an authorized representative of the Mining Board and by the miners' representative.

- (e) All SCSR devices required under this Section shall be stored in caches that are conspicuous and readily accessible by each person in the mine.
- (f) An operator must require luminescent direction signs leading to each cache and rescue chamber to be posted in an mine, and a luminescent sign with the words "SELF-CONTAINED SELF-RESCUER" or "SELF-CONTAINED SELF-RESCUERS" must be conspicuously posted at each cache and rescue chamber.
- (g) Intrinsically safe, battery-powered strobe lights must be affixed to each cache and rescue chamber and must be capable of automatic activation in the event of an emergency.
- (h) The Mining Board must adopt and impose a plan for the daily inspection of SCSR devices required under subsections (a), (b), and (c) of this Section in order to ensure that the devices perform their designated functions each working day. Additional SCSE devices required under subsection (d) must be inspected every 90 days to ensure that the devices perform their designated functions, in addition to meeting all federal Mine Safety and Health Administration requirements.
- (i) Any person who, without the authorization of the operator or the Mining Board, knowingly removes or attempts to remove any self-contained self-rescue device or battery-powered strobe light approved by the Department from a mine or mine site with the intent to permanently deprive the operator of the device or light or who knowingly tampers with or attempts to tamper with the device or light is guilty of a Class 4 felony.
- (j) Beginning January 31, 2007, in addition to the SCSR devices required under subsections (a), (b) and (c) and operator provide a minimum of 30 SCSR devices in each cache located within a mine, in addition to federal Mine Safety and Health Administration requirements, Caches must be located no more than 4,000 feet apart throughout a mine.
- (k) An operator must submit for approval a plan addressing the requirements of subsection (j) of this Section to the Mining Board within 3 months after the effective date of this amendatory Act of the 94th General Assembly.

(225 ILCS 705/11.09 new)

Sec. 11.09. Rescue chambers.

- (a) Rescue chambers approved by the Mining Board must be provided at suitable locations throughout a mine.
- (b) Beginning January 31, 2007, rescue chambers approved by the Mining Board must be provided and located within 3,000 feet of each working section of a mine.
- (c) An operator must submit a plan for approval concerning the construction and maintenance of rescue chambers required under this Section to the Mining Board within 3 months after the effective date of this amendatory Act of the 94th General Assemble.

(225 ILCS 705/11.10 new)

Sec. 11.10. Materials for barricade. Each working sections of a mine must have an emergency sled or wagon located no more than 1,000 feet from the working faces of the mine with the following materials and amounts in constant supply:

- (1) 8 timbers of suitable length or roof jacks or equal capability;
- (2) 200 linear feet of brattice cloth of adequate height to the coal seam;
- (3) 2 hand saws
- (4) 20 1 X 6 brattice boards at least 12 feet long each;
- (5) 10 pounds of 10D nails;
- (6) 10 pounds of 16D nails;
- (7) 10 pounds of spads;
- (8) 25 cap boards;
- (9) 20 header boards
- (10) 2 axes;
- (11) 2 claw hammers;
- (12) One sledge hammer;
- (13) One shovel;
- (14) 10 bags of wood fiber plaster or 5 bags of cement or the equivalent;
- (15) 4 sets of rubber gloves; and
- (16) 5 gallons of sealed, distilled drinking water.

(225 ILCS 705/Art. 29 heading)

Article 29. Telephone and Wireless Communication Systems

(225 ILCS 705/29.07 new)

Sec. 29.07. Mine Technology Task Force; provision of rescue chambers and wireless devices.

- (a) The Director shall establish a Mine Technology Task Force Composed of representatives of an organization representing mine employees, coal operators, academis, and the communications industry. Each group shall submit the name of its representatives to the Director. The task force shall review and made recommendations to the Mining Board regarding the best available mine safety technologies, including, but not limited to, rescue chambers, wireless communications equipment, and wireless tracking devices for use in underground mines. The task force shall submit its initial findings to the Mining Board within 3 months after the effective date of this amendatory Act of the 94th General Assemble.
- (b) Rescue chambers, wireless emergency communications devices, and wireless tracking devices must be provided in each underground mine within 90 days after the equipment is approved by the federal Mine Safety and Health Administration. To the extent that any of these devices have already been approved by the Mine Safety and Health Administration, the operator shall provide the equipment in

each underground mine within 90 days after the effective date of this amendatory Act of the 94th General Assembly.

- (c) A temporary waiver of the requirements of subsection (b) of this Section of up to 90 days may be issued by the Mining Board if (i) the mining operator submits to the Mining Board a receipt of the product order and (ii) the manufacturer has certified that the product will be delivered within 90 days of the product order.

A copy of the Illinois Mine Technology Task Force Revised Recommendations was obtained from a contact at Draeger. The electronic copy did not indicate the date or the source of the information. However, it did contain information and revision recommendations to the Illinois General Assembly regulations (Public Act 094-101) included above. It appears that the document addresses individual portions of the regulation. It does this by providing an underlined copy of the existing portion of the regulation being addressed followed by a bulleted section for comments and recommended revised wording for that portion of the regulation. The following provides excerpts from the document related to SCSR caches and mine refuges.

Illinois Mine Technology Task Force Recommendations - Revised

(225 ILCS 705/11.08 new)

Sec. 11.08. Self-contained self-rescuer (SCSR devices; caches; strobe lights; luminescent signs.

- (a) An operator must require each person underground to carry a SCSR device on his or her person or, alternatively, a SCSR device must be kept within 25 feet of the person underground or may be kept more than 25 feet from the person underground if done according to a plan approved by the Mining Board.

- The task force recommends for the protection of workers on a working section, a filter self rescuer, M-20 or equivalent approved device, or a one hour SCSR be worn. If workers are wearing a FSR or M-20, or an equivalent approved device, then a storage plan must be approved by the Mining Board.

Revised Recommendation:

- The task force recommends if worker(s) on a working section carry a filter self rescuer, M-20 or equivalent approved device, an operator must provide to the Mining Board a storage plan if a SCSR device will be kept more than 25 feet from the worker(s). The Act failed to outline what is required in a plan submitted to the Mining Board and the task recommends either through interpretation of the Mining Board or through rule making the plan must include the requirements found in 225 ILCS 705.11.08(d), "The mine operator must include in the SCSR storage plan the location, quantity, and type of additional SCSR devices."

New Recommendation:

- (b) **An operator must provide for each person who is underground at least one SCSR device, in addition to the device required under subsection (a), that provides protection for a period of one hour or longer, to cover all persons in the mine. This additional SCSR device must be kept within 25 feet of the person underground or may be kept more than 25 feet from the person underground if done according to a plan approved by the Mining Board.**
- This section also failed to outline the requirements for a unit storage plan and the task force would recommend that the same requirements as listed for 225 705/11.08(a) be implemented.
- (c) **If the SCSR devices required under subsections (a), (b), and (c) are not adequate to provide enough oxygen for all persons to safely evacuate the mine under mine emergency conditions, the mine operator must provide additional SCSR devices in the primary and alternate escapeways to ensure safe evacuation for all persons underground through both primary and alternate escapeways. The Mining Board must determine the time needed for safe evacuation under emergency conditions for each of those locations at 1,000 foot intervals. The mine operator must submit a SCSR storage plan to the Mining Board for approval. The mine operator must include in the SCSR storage plan the location, quantity, and type of additional SCSR devices, each of which must provide protection for a period of one hour or longer, that are stored in the primary and alternate escapeways. The SCSR storage plan must also show how each storage location in the primary and alternative escapeways was determined. The Mining Board must require the mine operator to demonstrate that the location, quantity, and type of the additional SCSRs provide protection to all persons to safely evacuate the mine. The SCSR storage plan must be kept current by the mine operator and made available for inspection by an authorized representative of the Mining Board and by the miners' representative.**
- The task force recommends that the state adopt the company's Emergency Response Plan (ERP) as submitted to MSHA and the state mine inspector will physically verify that the distances are obtainable.

Comments:

- After reviewing what is required in an Emergency Response Plan (ERP), an ERP can not meet the requirements of 225 705/11.08(d). However, the provision found in 30 CFR 75.1714-4(c) require mine operators to submit an outby SCSR storage plan to the appropriate District Manager. The requirements of this plan mirror those in subsection (d).
- Subsection (d) contains several mandates for either the Mining Board or the mine operator. Those mandates are as follows; (1) mine operator must provide additional SCSR devices in primary and alternate escapeways, (2) the Mining Board must determine the time for safe evacuation under emergency conditions from each of those locations at 1,000 foot intervals, (3) the mine operator must submit a SCSR storage plan, (4) the Mining Board must require the mine operator to demonstrate that the location, quantity, and type of additional SCSRs provide protection, and (5) the SCSR storage plan must be kept current by the mine operator. The following is a break down of each mandate.
 - (1) is self-explanatory and is referenced in MSHA rules.
 - (2) apparently requires the Mining Board to have personnel visit each operation and conduct a “walk-out” test recording time at 1,000 intervals. The question can be asked regarding the intent of “those locations”, does this mean primary and alternate escapeways. If so is that from every unit in the mine? The task force may want to address this mandate. Also, what is definition of “emergency conditions”.
 - (3) is self-explanatory and also addressed in MSHA rules.
 - (4) is more restrictive than MSHA rules as 30 CFR 75.1714-4(c) states “District Manager may require the mine operator to demonstrate that the location, quantity, and type of additional SCSRs provide protection...” (emphasis added) Either it can be recommended that the Mining Board ask for revision to the act to mirror MSHA or set guidelines for how an operator can demonstrate what is required.
 - (5) requires the plan be kept current and open to inspection, yet nothing is required of mine operator to notify Mining Board of changes to SCSR storage plan. Unless periodic review of plan is performed, the Mining Board would be unaware that the original storage plan was revised.
- (f) **An operator must require luminescent direction sign leading to each cache and rescue chamber to be posted in a mine, and a luminescent sign with the words “SELF-CONTAINED SELF-RESCUER” or “SELF-CONTAINED SELF-RESCUERS” must be conspicuously posted at each cache and rescue chamber.**

- The task force recommends that signs can say self contained self rescuer or the equivalent. The wording in the section states “An operator must *require* luminescent direction signs” and should state “An operator must *provide* luminescent direction signs.” Emphasis added.

New Recommendation:

- Requiring mine operators to post a luminescent sign with the words “Self-Contained Self-Rescuer or Self-Contained Self-Rescuers” places an added burden on mine operators as MSHA is requiring at each storage location “a sign of reflective material with the words “SELF-RESCUERS” shall be conspicuously posted....” The task force recommends the language in the Act be amended to “SELF-RESCUERS. Also, the task force recommends the following wording be changed from “An operator must require luminescent direction signs...” to “An operator must provide luminescent direction signs....” This change is stronger language.

(g) Intrinsically safe, battery-powered strobe lights must be affixed to each cache and rescue chamber and must be capable of automatic activation in the event of an emergency.

(i) Any person who, without the authorization of the operator of the Mining Board, knowingly removes or attempts to remove any self-contained self-rescue device or battery-powered strobe light approved by the Department from a mine or mine site with the intent to permanently deprive the operator of the device or light or who knowingly tampers with or attempts to tamper with the device or light is guilty of a Class 4 felony.

- The task force recommends the requirement for battery-powered strobe light be removed from the Act, due to the explosive hazards created by the non-permissible strobe light.

New Recommendation:

- The task force recommends the language in the Act be amended to remove the requirement for battery-powered strobe lights as their presence may place added risk of a potential ignition hazard if damaged in an explosion. Their presence may delay mine rescue operations as mine rescue teams may be required to retreat if a battery-powered strobe light is found damaged. The presence of luminescent signs and life-lines attached to each cache will provide the means for escaping miners to find the storage caches.

(g) The Mining Board must adopt and impose a plan for the daily inspection of SCSR devices required under subsections (a), (b) and (c) of this Section in order to ensure that the devices

perform their designated functions each working day. Additional SCSR devices required under subsection (d) must be inspected every 90 days to ensure that the devices perform their designated functions, in addition to meeting all federal Mine Safety and Health Administration requirements.

- The task force recommends the Mining Board implement a plan per the manufacturers' recommendations or guidelines for inspection in lieu of daily inspection of SCSR device.

New Recommendation:

- The task force recommends the language in 225 705/11.08(h) be amended to reflect the plan adopted and imposed by the Mining Board is per the manufacturers' recommendations or guidelines for inspection in lieu of a daily inspection of SCSR devices.

(j) Beginning January 31, 2007, in addition to the SCSR devices required under subsections (a), (b), and (c), an operator must provide a minimum of 30 SCSR devices in each cache located within a mine, in addition to federal Mine Safety and Health Administration requirements. Caches must be located no more than 4,000 feet apart throughout a mine.

- The task force recommendations on Section 11.08(d) are sufficient to include the requirements of Section 11.08(j); i.e., the task force recommendation for (d) usurps the requirements of (j), hence the task force recommends the removal of Section 11.08(j) and its associated paragraph (k).

Comments:

- The section needs amended and the current recommendation does not give the justification for an amendment.
- The additional SCSR devices beyond what is required by MSHA does not increase a miner's ability to escape. Any miner escaping from a unit will already have two SCSRs in his or her possession based on SCSR requirements found in subsections (a), (b), and (c). A miner arriving at an SCSR cache will replace the one being worn and will continue to carry a second unit.
- The new legislation does not reference federal requirements for cache distance (...a distance of no further than an average miner could walk in 30 minutes...). The 4,000 feet caching distance is more restrictive than MSHA. MSHA policy is allowing either an actual performance or NIOSH study results to determine cache distance. The 4,000 feet distance pursuant to MSHA policy would only affect coal mines under 50" coal seam height.

(225 ILCS 705/11.09 new)

Sec. 11.09. Rescue Chambers.

(c) Beginning January 31, 2007, rescue chambers approved by the Mining Board must be provided and located within 3,000 feet of each working section of a mine.

- The task force recommends that one rescue chamber be located on each working section within 3000 feet of the tailpiece. These rescue chambers may be portable or with a fixed wall construction; block, poured concrete, steel or equivalent construction.

New Recommendation:

- The task force recommends to the Mining Board that one rescue chamber be located within 3,000 feet outby the belt tail for each working section. These chambers may be portable or with a fixed wall construction; block, poured concrete, steel or equivalent construction.

(c) An operator must submit a plan for approval concerning the construction and maintenance of rescue chambers required under this Section to the Mining Board within 3 months after the effective date of this amendatory Act of the 94th General Assembly.

- The task force recommends the State Mining Board adopt the requirements found in the West Virginia Mine Safety Technology Task Force Report pursuant to rescue chambers. However, the task force would recommend only a first aid or EMT kit be required and battery powered internal strobe light be omitted. The WV rescue chambers requirements are as follows:
 - provide a minimum of 48 hours life support (air, water, emergency medical supplies, and food) for the maximum number of miners reasonably expected on the working section;
 - capable of surviving an initial event with a peak overpressure of 15 psi and a flash temperature of 300 degrees Fahrenheit;
 - constructed such that it will withstand normal handling and pre-event mine conditions;
 - provide for rapidly establishing an internal shelter atmosphere of
 - Oxygen above 19.0%
 - Carbon Dioxide below 1%
 - Carbon Monoxide below 50 ppm, and
 - An apparent-temperature not exceeding 95 degrees Fahrenheit;

- provide the ability to monitor carbon monoxide and oxygen inside and outside the shelter/chamber;
- provide a means for entry and exit that maintains the integrity of the internal atmosphere;
- provide a means for intrinsically safe power if required;
- provide a minimum of eight quarts of water per miner;
- provide a minimum of 4000 calories of food per miner;
- provide a means for disposal of human waste to the outside of the shelter/chamber;
- provide an EMT kit;
- have provisions for inspection of the shelter/chamber and contents;
- contain manufacturer recommended repair materials;
- provide a means of communications to the surface, and
- only contain MSHA approved materials where applicable.

Comments:

- First aid kit has been removed from the list of requirements. It is felt the chamber should have more medical supplies and equipment than what a first aid kit could provide.

Ohio – United States

A copy of the Ohio Underground Mine Safety Task Force, Report and Recommendations was reviewed for content relating to mine refuge chambers. No recommendations related to mine refuges were reviewed. However, excerpts from the report that are related to barricading are provided below.

**Ohio Underground Mine Safety Task Force
Report and Recommendations
March 2006**

Excerpt from **Executive Summary**

Task Force recommendations are made in several areas:

- Increased and better miner training
- Early detection of carbon monoxide
- Installation of lifelines/taglines systems
- Additional and better rescue equipment
- Better rescue team training
- Mine emergency drills

The Task Force also recommends that ODNR convene a Focus Group annually to review mine safety requirements, procedures, training and emerging technology in order to promote continuous improvement of Ohio's mine safety. The Task Force recognizes the need and importance of two-way radio systems, safe rooms and personal trackers, and recommended further study and support to push development of these

emerging technologies that will enhance the safety of Ohio's underground mine workers.

Excerpt from Section **B. Protection**

B-5) A continuing evaluation, study and eventual implementation of barricading technology is needed. It is therefore proposed that a separate group be appointed to study utilization and implementation of these technologies and report back to the Director or ODNR on the status and implementation of these recommendations within a six-month period.

During the work and deliberations of the Underground Mine Safety Task Force, presentations were made by several groups which highlighted the availability of more advanced barricading technology than that which has traditionally been utilized in the underground mining industry.

These technologies, while of NASA and military origin, have obvious benefit to the underground extractive industries and could provide a "safe haven" for trapped miners for a four-day period or more. Several other states and federal agencies are evaluating the issues involved in the transfer of this technology and the Task Force agrees that substantial gains would be made in Ohio's efforts to improve mine safety as these technologies can be commercialized and utilized.

It is therefore proposed that a separate group be appointed to study utilization and implementation of these technologies and report back to the Director of ODNR on the status and implementation recommendation within a six-month period.

West Virginia – United States

The West Virginia mining regulations require refuge chambers to be maintained within 1000 feet of a working face. However, specifications relating to the contents, construction, and outfitting of the chambers do not provide high specificity. A second document produced by the West Virginia government's Mine Safety Technology Task Force provides specific recommendations on the design and usage of chambers. Excerpts from both documents pertaining to refuge chambers are included below.

**Mining Laws, Rules and Regulations
2006 Reference Manual
West Virginia Office of Miners' Health, Safety and Training**

**Emergency West Virginia Legislative Rule
Title 56, Series 4 – Emergency Rules Governing Protective Clothing and
Equipment**

§56-4-2. Preamble.

2.1. Purpose – The primary goal of section fifty-five, article two, chapter twenty-two-a of the Code is to protect the health and safety of this State's coal miners by requiring minimum standards for the protective clothing and equipment worn by each underground miner. The purpose of these rules is to implement the mandate of section fifty-five, article two, chapter twenty-two-a of the Code by requiring coal mine operators to provide each underground miner with certain protective equipment and by detailing the requirements for such protective equipment. In implementing such mandate, it is recognized that different types of protective equipment may be developed to satisfy the minimum requirements for protective equipment for each mine, depending upon the number of employees of the particular mine, the location of the particular mine, the physical features of the particular mine, and technological advances.

2.1.1. Exiting a mine is the primary escape procedure to be used by miners in the event of an emergency underground. Self-contained self-rescue devices ("SCSRs") are intended primarily to provide miners with breathable air while attempting to exit the mine during an emergency. The secondary purpose of SCSRs, however, is to provide a source of breathable air to miners that cannot exit a mine during an emergency and must await rescue by personnel on the surface. Emergency shelters/chambers also provide a source of breathable air for trapped miners unable to escape from the mine. Wireless emergency communication devices and wireless tracking devices are intended to assist in both directing miners out of an endangered mine and locating trapped miners awaiting rescue by personnel on the surface. In addition to the purposes stated above, the intended purpose of these rules is to establish a regulatory regime enabling the proper implementation of these technologies in West Virginia's underground mines.

§56-4-4. Mine Safety Technology Task Force.

4.2. The task force, working in conjunction with the Director, shall immediately commence a study to determine the commercial availability and functional and operational capability of the SCSRs, emergency shelters/chambers, wireless communication devices and wireless tracking devices required hereunder. The task force shall also study issues related to the implementation, compliance and enforcement of the safety requirements contained herein. Additionally, the task force may study

related safety measures, including the provision of additional surface openings and/or escapeways in lieu of or in addition to the provision of SCSRs or emergency shelters/chambers. In conducting its study, the task force shall, where possible, consult with, among others, mine engineering and mine safety experts, radiocommunication and telemetry experts and relevant state and federal regulatory personnel.

4.5. Prior to approving any emergency shelter/chamber, wireless communication device or wireless tracking device pursuant to the provisions of sections 5.4, 8.1, and 9.1 of these rules, respectively, the Director shall review the task force's written report and the findings set forth therein and shall consider such findings in making any approval determination.

§56-4-5. Self-Contained Self-Rescue Devices Provided for Escape from Mines.

5.4. Emergency Shelters/Chambers for Use in the Event That Immediate Exit is not Possible.

5.4.1. An emergency shelter/chamber shall be maintained within one thousand (1000) feet of the nearest working face in each working section. Such emergency shelter/chamber shall be approved by the Director and shall be constructed and maintained in a manner prescribed by the Director.

5.4.2. Upon the Director's receipt of the written report required by section 4.4 of these rules, the Director shall review the written report and the findings set forth therein and shall consider such findings in making approval determinations regarding any emergency shelter/chamber.

5.4.3. Any emergency shelter/chamber approved by the Director shall be:

- a. equipped to provide each miner at the working section with no less than twenty-four (24) hours of breathable air;
- b. constructed in such a manner so as to reasonably exclude dangerous air and gases from the interior of the rescue shelter/chamber;
- c. properly equipped with first aid materials;
- d. equipped with sufficient amounts of food and water to sustain each miner at the working section for at least twenty-four (24) hours while awaiting rescue;
- e. equipped with a device for communication with rescuers or other persons on the surface; and
- f. maintained in accordance with applicable MSHA requirements.

- 5.4.4. As soon as practicable, the Director shall notify all operators of the emergency shelters/chambers approved for use in underground coal mines.
- 5.4.5. Each operator shall train each miner in the use of the approved emergency shelter/chamber employed at the mine, and refresher training courses for all underground employees shall be held during each calendar year. This training shall be in addition to any annual retraining required by MSHA.
- 5.4.6. If there are no emergency shelters/chambers approved within one year of the Director's receipt of the task force's report, operators shall install in lieu of an emergency shelter/chamber, caches of SCSRs sufficient to provide each miner reasonably expected to be at the working section with no less than sixteen(16) additional SCSRs, or an equivalent amount of breathable air.
- 5.4.7. Sixteen (16) SCSRs may be used in lieu of an emergency shelter/chamber when mine design or layout prohibits use of such facilities.

§56-4-6. Storage Cache Plan.

6.4. The Storage Cache Plan shall include the following:

- 6.4.1. The size and physical features of the mine;
- 6.4.2. The maximum number of persons underground during each working shift;
- 6.4.3. The proposed location of the various storage caches and the emergency shelter/chamber in relation to persons underground; and
- 6.4.4. A schedule of compliance, which shall include:
 - a. a narrative description of how the operator will achieve compliance with subdivision (2), subsection (f), section fifty-five, article two, chapter twenty-two-a of the Code.
 - b. a schedule of measures, including an enforceable sequence of actions with milestones, leading to compliance; and
 - c. a statement indicating when the implementation of the proposed plan will be complete.
- 6.4.5. Any such schedule of compliance shall be supplemental to, and shall not sanction noncompliance with, the applicable requirements on which it is based.
- 6.7.3. Within thirty (30) calendar days of the Director notifying operators of the emergency shelters/chambers approved by the Director under these rules, the operator shall submit a revised Storage Cache Plan in accordance with the provisions of this section setting forth the type of emergency shelter/chamber to be installed pursuant to section 5.4 these rules. The revised storage cache plan

shall also include a revised schedule of compliance and information regarding the emergency shelter/chamber that corresponds to the information regarding the storage caches required under this section of these rules.

**Mine Safety Recommendations
Mine Safety Technology Task Force
May 29, 2006**

EMERGENCY SHELTERS/CHAMBERS

The Task Force has concluded that the first and preferred option for miners in an emergency is to escape. However, it has found that options exist to provide the primary function of an Emergency Shelter/Chamber which is designed to potentially sustain life after a major underground event such as an explosion and where escape is cut off. The Task Force has developed recommended minimum requirements for the emergency shelter/chamber and its use.

In developing recommendations the Task Force reviewed summaries of mine accidents that resulted in barricading of miners and developed a scenario. The scenario used is of an accident in which miners within 1,000 feet of the working face have survived a methane explosion. The Task Force's scenario does not include secondary explosions or on-going fires in the immediate area. The miner will have made every attempt to exit and found all escape ways impassable. As a last resort, they have been forced to return to the shelter/chamber to await rescue. We have assumed that miners approaching the emergency shelter/chamber will have consumed most of their SCSR time, be exhausted from escape attempts, with some injured and all under great stress. In this condition, the miners will need to be protected by the shelter/chamber within minutes of reaching it and for a period of at least 48 hours.

Emergency Shelter/Chamber Recommendations

2. The Director shall require, in each underground mine, an emergency shelter/chamber, it shall be located in a crosscut no more than 1,000 feet from the nearest working face and shall be accurately located on mine maps.
3. The Director may approve, as an alternative to a shelter/chamber, an additional surface opening located no more than 1,000 feet from the nearest working face and accurately located on mine maps.
4. The Director shall acquire, no later than July 1, 2006, the necessary technical/engineering support needed to evaluate the performance of emergency shelter/chamber components/systems, and to review the effectiveness of emergency shelter/chamber plans.

5. The Director shall, no later than July 10, 2006, issue an open opportunity for emergency shelter/chamber providers to submit products for approval.
6. The applicant is to submit documentation including a certification be an independent licensed professional engineer that its unit meets the requirements.
7. The Director shall maintain a current list of approved emergency shelter/chambers on the West Virginia MHS&T web site www.wvminesafety.org.
8. After an emergency shelter/chamber has been approved, any modifications must be submitted for approval by the Director.
9. The Director shall convene the Mine Safety Technology Task Force no less than once per month through June 30, 2007 for the purpose of reviewing progress by manufacturers, regulators, and operators toward achieving the goals set forth in SB-347 and to review the functional and operational capability of necessary mine safety and health technologies. The Task Force shall submit a report to the Director of its findings and recommendations.
10. No later than April 15, 2007 all underground mine operators shall submit an emergency shelter/chamber plan for approval by the Director. The design, development, submission, and implementation of the shelter/chamber plan shall be the responsibility of the operator of each mine.
11. Within thirty (30) calendar days after submission of the emergency shelter/chamber plan, the Director shall either approve the emergency shelter/chamber plan or shall reject and return the plan to the operator for modification and resubmission, stating in detail the reason for such rejection. If the plan is rejected, the Director shall give the operator a reasonable length of time, not to exceed fifteen (15) calendar days, to modify and resubmit such plan.
12. Within 15 days of approval by the Director, the underground mine operator shall submit as an addendum to its emergency shelter/chamber plan a copy of any contract, or purchase order, or other proof of purchase of any equipment required to complete the emergency shelter/chamber and for installation and ongoing maintenance.
13. After the Director has approved an operator's emergency shelter/chamber plan, the operator shall submit revisions to the emergency shelter/chamber plan at any time that changes in operational conditions result in a substantive modification. In addition, at any time after approval, the operator may submit proposed modifications or revisions to its plan along with reasons therefore to the Director. Within thirty (3) days after receipt by the Director of any proposed revisions or modifications to the emergency shelter/chamber plan, the Director shall either approve

or reject the revisions, stating in detail the reasons for such rejection.

14. If the Director, in his sole discretion, determines that an operator has failed to provide an emergency shelter/chamber plan, has provided an inadequate emergency shelter/chamber plan, has failed to comply with its approved emergency shelter/chamber plan, or has failed to provide a copy of any contract, purchase order or other proof of purchase required under this section, in an effort to delay, avoid or circumvent compliance with subdivision (2), subsection (f), section fifty-five, article two, chapter twenty-two-a of the Code or these rules, the Director shall issue a cessation order to the operator for the affected mine.
15. In developing the emergency shelter/chamber plan and any revisions, the operator shall take into consideration the physical features of the particular mine, emergency plans, advances in emergency shelter/chamber technologies and any other aspect of the particular mine the operator deems relevant to the development of the emergency shelter/chamber plan.
16. A copy of the approved emergency shelter/chamber plan shall be provided to the mine rescue teams providing coverage for the mine. Copies of the most recent version shall be available at the mine for emergency responders. As changes are made to the system, updated versions shall be submitted to the above parties.
17. The proposed emergency shelter/chamber plan shall:
 - describe the structure and operations of the emergency shelter/chamber and its role in emergency response;
 - ensure that emergency shelters/chambers are included in initial mine hazard training in such a manner that it is in compliance with all manufacturer's requirements and it provided yearly in addition to annual refresher training. All training shall be recorded and made available upon request;
 - ensure weekly inspections of emergency shelters/chambers and contents shall be conducted by a certified mine foreman/fireboss and recorded in weekly ventilation examination book;
 - ensure that weekly safety meetings review the current location of applicable emergency shelters/chambers and results of the latest inspection;
 - ensure that emergency shelters/chambers shall be equipped with easily removeable tamper-proof tags such that a visual indication of unauthorized access to the emergency shelter/chamber can be detected; and
 - ensure that the mine's communication center shall monitor any communication systems associated with the emergency shelter/chamber at all times that the mine is occupied.

18. The proposed emergency shelter/chamber shall include the ability to:

- provide a minimum of 48 hours life support (air, water, emergency medical supplies, and food) for the maximum number of miners reasonable expected on the working section;
- be capable of surviving an initial event with a peak overpressure of 15 psi and a flash temperature of 300 degrees Fahrenheit;
- be constructed such that it will be protected under normal handling and pre-event mine conditions;
- provide for rapidly establishing an internal shelter atmosphere of
O₂ above 19.5%,
CO₂ below 0.5%,
CO below 50 ppm, and
And 'apparent-temperature' of 95 degrees Fahrenheit;
- provide the ability to monitor carbon monoxide and oxygen inside and outside the shelter/chamber;
- provide a means for entry and exit that maintains the integrity of the internal atmosphere;
- provide a means for intrinsically safe power if required;
- provide a minimum eight quarts of water per miner;
- provide a minimum of 4000 calories of food per miner;
- provide a means for disposal of human waste to the outside of the shelter/chamber;
- provide a first aid or EMT kit in addition to a section first aid kit;
- have provisions for inspection of the shelter/chamber and contents;
- contain manufacturer recommended repair materials;
- provide a battery-powered internal stroke light visible from the outside indicating occupancy;
- provide a means of communications to the surface; and
- only contain MSHA approved materials where applicable.

19. The Director may require modifications to an emergency shelter/chamber approval or an emergency shelter/chamber plan at any time following the investigation of a fatal accident or serious injury, as defined by Title 36, Series 19, Section 3.2, if such modifications are warranted by the findings of the investigation.

MANUFACTURERS

OVERVIEW

MINE REFUGE EQUIPMENT MANUFACTURERS

The NTTC performed a market study of refuge chamber manufacturers. Both commercial manufacturers and entities that build chambers within the mine strata (termed permanent refuge chambers in this report) were researched. The following overview provides a summary of the manufacturers and mining companies identified during the search.

Refuge Chamber Manufacturers

The following companies were identified as manufacturers of mine refuge chambers and related supplies (such as air purifiers):

1. ChemBio Shelter, Inc.
2. Cowan Manufacturing Pty Ltd
3. Draeger Safety AG & Company
4. Gamma Services International, Inc.
5. Jack Kennedy Metal Products & Buildings, Inc.
6. MineARC Systems
7. Modern Mine Safety Supply, LLC
8. Molecular Products Ltd.
9. North Fringe Resources, Inc.
10. Phoenix First Response (a subsidiary of Micon)
11. Rimer Alco North America (RANA)-Medical
12. Shairzal Safety Engineering
13. Strata Products, Inc.

Of these companies, Cowan Manufacturing, Draeger, MineARC, and Shairzal appear to be the leaders in the international mining industry. Kennedy, Gamma, ChemBio Shelter, and Modern Mine Safety are companies that appear to be concentrating on entering the developing United States market. Molecular Products and RANA Medical produce air purifying equipment that could be or are used in chambers.

The attached table titled 'Mine Refuge Manufacturers' provides a summary of the company information and products for each of the manufacturers mentioned. More detailed product information and marketing materials obtained from the company and online sources are provided for each manufacturer under separate tabbed sections. At the beginning of each tabbed section there is a brief summary of each company, their products, and any information about their refuges related to sales and placement of their units in mines.

Contact was attempted with each company. A summary of the contacts made/attempted is provided in the Appendix.

Permanent Refuge Chambers

The NTTC performed research to provide an overview of the companies and countries that build permanent or semi-permanent refuge chambers. These chambers are constructed into the strata of a mine or constructed by erecting barriers to seal off a specific area of the mine (typically a cross cut). Canada and South Africa were identified as countries that provide a good overview of permanent refuge chambers. Information about permanent refuge chamber design, location, and reasoning are included in the following documents located in Volume II of this report:

Report Title	Volume	Tab	Comments
Assessment of Refuge Bay Designs in Collieries, Final Project Report	II	1	Appendix A provides a summary of South African mine refuges.
Canadian Experiences with Refuge Stations Presentation	II	5	Provides a summary of in situ mines in Canada.
Coal Mine Refuge Chambers, Design Concept & Provisions Presentation	II	6	Overview of permanent mine refuge chamber design.
Design and Installation of Refuge Chambers	II	8	Overview of South African regulations and examples of what mines have used refuges in emergencies.
Guidelines for Rescue Chambers Presentation	II	11	Refuge chamber proposed guidelines and study.
Response Letter to Information Request for Underground Mine Rescue Equipment and Technology from Mine Safety and Health Administration	II	20	San Juan Coal Company description of why they use permanent refuge chambers.

Additionally, two companies with mines known to have permanent refuge chambers were contacted to obtain additional information regarding their chambers. Emails were sent to Hillsborough Resources Limited of British Columbia, Canada and Newmont Mining Corporation, Colorado, USA. To date, no response has been received. NTTC will forward any future information received to NIOSH for inclusion into this report.

MINE REFUGE MANUFACTURERS
30 November 2006

Manufacturer	Product Name	Contact Information	Refuge Type	Construction	Dimensions	Features	Additional Information
ChemBio Shelter, Inc.	Life Shelter	Allentown, PA, 1-800-344-6275 http://www.chembioshelter.com/default.htm	Rapid deployable pre-fabricated portable unit	Fabric covered air beam	Available in these heights: 20"-30", 36"-60", 84", and customizable.	Rapid deployment, flame retardant, puncture/tear resistant fabric, skid mounted, 96 hours of protection, no external power, air lock/positive pressure, oxygen generators, CO ₂ and CO scrubbing, activated carbon air filter, field repair kit, food, water, first aid kit, chemical toilet, monitors for O ₂ , CO ₂ , CO, and temperature. Capacity up to 18 people.	
Cowan Manufacturing PTY LTD	Fresh Air Base	94 Walker St., PO Box 185 Warners Bay NSW 2282 Australia Phone: (61)02 4954 6588 Fax: (61) 02 4956 5762 http://www.cowanmfg.com.au/	Pre-fabricated portable unit	Welded steel airtight chamber		Low roof design, 2 on board powered CO ₂ scrubbers with 24 capacity, cold air supply, connects to mine compressed air supply with backup O ₂ supplied by on-board cylinders, forced air curtain at entry portal, sealed doors, emergency exit, chemical toilet, wash basin, connects to external power with 24 hour internal battery backup	
Draeger Safety, Inc.	Multiple Refuge Shelters (may also be customized)	101 Technology Dr., Pittsburgh, PA 15275-1057 Tel: (412) 787-8383 Fax: (412) 787-2207 http://www.draeger.com/index.html	Pre-fabricated portable unit	Steel frame	26.2' long x 8' wide x 8.2' high for Model DSSI RS24-15	Gas tight doors, air lock entry, escape hatch, exhaust valves, air conditioning, positive pressure, over pressure gauge, O ₂ and CO ₂ monitor, CO ₂ scrubber, on board power and air for up to 24 hours, external power hookup, first aid, chemical toilet, first aid, capacity up to 15 people.	Draeger will construct a shelter to any specifications using both steel and inflatable shelters. Will modify specifications to meet any new coal mine requirements.

MINE REFUGE MANUFACTURERS
30 November 2006

Manufacturer	Product Name	Contact Information	Refuge Type	Construction	Dimensions	Features	Additional Information
Gamma Services International, Inc.	Rescue POD	948 Nail St., PO Box 306, Clay, KY 42404 Tel: 270-664-9700 (disconnected) Fax: 270-664-2002 http://gsimining.com/	Pre-fabricated portable unit	Welded steel	16' long x 5.7' wide x 3.7' high	Low roof design, 96+ hours of protection, CO, C _H 4, CO ₂ , N ₂ , AR scrubbing, dehumidifier, additional SCBA's, temperature reduction system, O ₂ transfer system filters and concentrates ambient mine air with as low as 4% O ₂ concentration to 18% refuge chamber O ₂ , monitors interior and exterior C _H 4 and CO ₂ levels, water, food, canister toilet, chem-stick lighting, N2 foaming fire fighting capability. 16 person capacity	
Jack Kennedy Metal Products & buildings, Inc.	The Kennedy Chamber	PO Box 138 Taylorville, IL 62568 Tel: 217-287-7231 Fax: 217-287-7232 http://www.kennedymetal.com/	Portable steel pre-fabricated	Steel plate		100 hour life support at full capacity, 200 hours life support at 1/2 capacity, onboard compressed O ₂ supply with no chem, heat, or ignition source, CO ₂ scrubber with a changeout timer, positive pressure, no external power requirements, built on skid, viewing portal, 300 hour lighting, reading material. 28 person capacity.	Unit can be hardened for more extreme conditions. Comes in three design options - House (fully rigid assembly), folding house (compact unit that requires unfolding to deploy, and Skid (very low profile for low roof conditions)
Mine Safehouse, LLC						Will withstand secondary blasts of up to 75 psi. Fire resistance in excess of 2000 F.	Attempted contact multiple times. Phone has been disconnected. Appear to be out of business

MINE REFUGE MANUFACTURERS
30 November 2006

Manufacturer	Product Name	Contact Information	Refuge Type	Construction	Dimensions	Features	Additional Information
MineARC Systems (also distributed by Molecular Products LTD)	Mine Refuge Chamber	4730 Bronze Way, Dallas, TX 75236 Tel: 214-337-5100 Fax: 214-337-5103 www.minearc.com		5 mm welded steel plate airtight chamber		36 hours without external power or air, escape hatch, viewing portal, internal and external fire extinguishers, air conditioning, CO and CO ₂ scrubber, three separate air supplies (filtered compressed mine air, oxygen cylinders, oxygen candle), gas detection system, powered by mine power with 36 hour battery backup, can be lifted or towed, telescoping roof (24" to 72") for low seam insertion, intrinsically safe. 20, 15, 12 people are standard sizes for coal refuge.	Designs multiple refuge chamber for various conditions, including three basic designs for coal mines. All chambers are CE certified (indicates that it meets specified European Economic Area [EEA] country's regulations).
Modern Mine Safety Supply, LLC	Mine Refuge Chamber		Steel pre-fabricated mobile unit	1/4" steel plate with welded joints	Customizable to any size	Refuge One air scrubber unit, stand-alone self-contained 24 volt air conditioner, food and supplies, interior and exterior environmental sampling capability, compartmentalized toilet, wheels for portability, viewing portal. "Likely to withstand fairly substantial secondary explosion. Unit capacity is customizable.	
North Fringe Resources Inc.	Ultimate Portable Refuge Station	Box 1540 Nipawin, SK S0E 1E0 Canada	Steel pre-fabricated mobile unit	Steel plate pressed to form minimal joints.	Customizable to any size	40 hours of power, double door air lock, food and supplies, CO ₂ /H ₂ S/LEL/O ₂ detection, air conditioning, CO and CO ₂ scrubber, high-tech communication system, battery operated, chemical toilet,	Designed to withstand open flame and heat
Phoenix First Response	Phoenix Chamber	25 Allegheny Square, Glassport, PA 15045 Tel: 412-664-7788 Fax: 412-664-7717	Portable steel pre-fabricated or in-situ design	Customizable	Customizable to any size	Phoenix will custom build a phoenix chamber to accommodate the risks identified through a risk assessment of a mine. Design can be either in situ or portable steel structure. Typical chamber design includes air supply, chemical toilet, entry air lock, additional SCSR, 50 psi blast resistant entries, first aid supplies, corners of structure braced for over pressure resistance, insulated internal walls.	

MINE REFUGE MANUFACTURERS
30 November 2006

Manufacturer	Product Name	Contact Information	Refuge Type	Construction	Dimensions	Features	Additional Information
RANA-Mining	Refuge One Air Centre	72 Scurfield Blvd., Winnipeg, Manitoba R3Y 1G4 Canada Tel: +1 204 928 1409 Fax: +1 204 489 1336 www.ranamedical.com	Refuge Station	Single Bed Unit or Double Bed Unit	Single: Length 57.25" x Width 29.5" Depth: 25.5 (15" with cover removed) wide, weight 720 lbs (500 lbs w/o O ₂ cylinders) Double: Length: 55.5" Width: 31" Depth 65.5", Weight: 1545 lbs (1155 w/o O ₂ cylinders)	Removes Carbon Dioxide and replenishes Oxygen to maintain breathable air. Does not require any compressed air or connection to surface. 36 hours without external power or air. Small size, easy to relocate. Simple to operate under stressful emergency conditions. Skid mounted for portability. Modular design in 2 sizes can be combined for any sized refuge station needs. Ten year underground life expectancy.	
RANA-Mining	"The Tommyknocker" Mine Refuge Chamber	As Above	Refuge Chamber	12-gauge steel	Standard unit is 14' long and 7' high. Capacity can be increased by increasing the length of the chamber in 4' sections.	14' chamber accommodates 8-10 people and each additional 4' section accommodates an additional 4-5 people. 2 rooms with one small 2.5' in depth serving as the air lock room & toilet area. Padded benches running along each side of chamber. Storage located under benches & storage cupboard in air lock room. Window located in doors. Interior lights operate on battery or mine power. Warning lights located inside chamber indicating batteries need charging. There can be two sources of air supply: Rana's Refuge One Air Centre or the mine's compressed air system. The Tommyknocker is equipped to hook up to compressed air which is filtered, pressure reduced and has a sound muffler. Water dispenser supplied. Reflective signage throughout identifying Refuge Chamber	Carbon monoxide scrubber Gas Monitor Air Conditioning

MINE REFUGE MANUFACTURERS
30 November 2006

Manufacturer	Product Name	Contact Information	Refuge Type	Construction	Dimensions	Features	Additional Information
Shirazal Safety Engineering	Refuge Chamber	28 Jersey Rd, Bayswater, VIC 3153 Australia Tel: +613 9720 3877 Fax: +613 9720 3529 www.shirazal.com.au	pre-fabricated	Welded steel airtight chamber	Customizable to any size	Self-closing entry, 40 + hour internal air supply and scrubbing system, entry airlock, seating, drinking water, chemical toilet, lighting, first aid kit, rear escape hatch, fire extinguisher, remote controlled air conditioning, reflective signage. Customizable from 4 to 40.	battery backup system, oxygen enhancement, base station communication, CO diversion system, I.T. and QDS attachments, 1000v/240v step down transformer
Strata	Portable Fresh Air Bay	3939 Roswell Rd., Ste. 100, Marietta, GA 30062, USA Tel: 1-800-691-6601 Fax: 770-321-2520 www.strataproducts.com	Portable inflatable refuge chamber	Fire resistant rugged welded fabric	Customizable to any size	Positive pressure vessel, air lock. Low blast resistance, flame retardent material, customizable to any size.	
Strata	Emergency Refuge Station		Fresh Air Base	Welded steel airtight chamber	Customizable to any size	48 hour back-up air supply that is fully scalable, 36 hour back-up power supply that is fully scalable, remote control, reverse cycle air conditioner to maintain a comfortable environment, 12 volt lighting system, drinking water and food, chemical toilet in separate compartment, durable, cushioned seating for all occupants, storage areas, forklift guides, lifting facility and skid base. 4-Gas monitoring system, escape hatch, airlock entry to minimize contaminants entering the station, self closing door, fire extinguisher, fully reflective signage for greater visibility	

MINE REFUGE MANUFACTURERS
30 November 2006

Manufacturer	Product Name	Contact Information	Refuge Type	Construction	Dimensions	Features	Additional Information
RELATED EQUIPMENT ChemBio	MRE		Self-contained operational rations	Flexible meal packed in a flexible meal bag.	Twenty-four different varieties of meals	The contents of one MRE meal bag provides an average of 1250 kilocalories (13% protein, 36% fat, and 51% carbohydrates). It also provides 1/3 of the Military Recommended Daily Allowance of vitamins and minerals determined essential by the surgeon General of the United States.	
Molecular Products LTD	PACU (Portable Atmosphere Control Unit)	Mill End, Thaxted, Essex, CM6 2LT, United Kingdom Tel: +44 (0) 1371 830676 Fax: +44 (0) 1371 830998 http://www.molecularproducts.co.uk/				CO ₂ absorber, O ₂ generator. Supports 4 people for 24 hours in a 32 m ³ space.	
Molecular Products LTD	CASPA (Carbon dioxide Self Powered Adsorber						
Molecular Products LTD	SCOG (Self Contained Oxygen Generator)					Raises O ₂ content in a 24 m ³ space from 18-21%. 720 litres of O ₂ over 25 minutes.	
Shairzal	Carbon Dioxide Scrubber		Stand Alone Fit In			The Refresh 48 is a self contained system that is designed to provide oxygen at controlled rates and to remove carbon dioxide from air in an enclosed or confined space. Powered by 240 Volt and has an inbuilt battery backup. It can run for a 48 hour period without main power connected.	

MINE REFUGE MANUFACTURERS
30 November 2006

Manufacturer	Product Name	Contact Information	Refuge Type	Construction	Dimensions	Features	Additional Information
Shairzal	Breathing Air System for Escape Vehicles		Fitted into any vehicle	Customizable		Custom made options to suit any vehicle. Variable duration depending on vehicle type & configuration., supplied in kit form and transferable between vehicles.	
Strata	AIRDOC	3939 Roswell Rd., Ste. 100, Marietta, GA 30062, USA Tel: 1-800-691-6601 Fax: 770-321-2520 www.strataproducts.com	Change over station	Welded Steel	The AIRDOC is a transitional unit and is designed for walk through	The first level of safety is a filtration system that is connected to mine air. While Mine air is available and turned to the "ON" position, the duration of air supply is virtually unlimited. As a secondary level, the AIRDOC has a powerless breathing air system which provides breathable air using compressed oxygen cylinders and a CO ₂ scrubbing system. Oxygen from cylinders is directed through the Carbon Dioxide Scrubber and released into the center of the change over area of the AIRDOC. When operating on 100% stand alone mode, the AIRDOC provides 9 hours of breathable air. Food, water communication devices, extra SCSRs and first aid kits can be stored in the units. Fitted with a storage rack that holds 50 self rescuers.	
Strata	Carbon Dioxide Scrubber		Self contained system	Welded steel	36" wide x 16" deep x 39" high, 154 lbs.	Self contained system designed to provide oxygen at controlled rates and remove carbon dioxide from the air in enclosed areas. It utilizes H-size oxygen cylinders and soda lime chemicals. System is electrically powered and has a 36 hour built in battery back-up if main power is lost.	Powerless CO ₂ scrubbing system that requires no electrical power to run. Utilizes only compressed air cylinders and soda lime chemicals to scrub the CO ₂ out of the air.
Strata	ExtendAir® CO ₂ Absorbent Curtain			Lithium Hydroxide curtain		Fast and easy deployment with no tools or electrical power required. Begin working immediately, tested performance, currently used by the US Navy. Packaged in US Mil-B-131H soft foil inner pouches and rigid ammo box outer boxes.	

CHEMBIO SHELTER

ChemBio Shelter, Inc.

ChemBio Shelter, Inc. (ChemBio) manufactures fabric, airframe chemical and biologic shelters. They also have begun to manufacture shelters specifically for mining. Information about their refuges was obtained from various internet sources (including their web page) and by contacting them directly. Information obtained is attached.

Ed Roscioli, CEO of ChemBio, was contacted to obtain information on their shelters. He indicated that the company is currently concentrating on entering the US market for mine shelters and is not pursuing mining in other countries at this time. They are currently constructing their shelters to the specifications under the new West Virginia regulations. However, ChemBio recommends outfitting shelters for 96 hours to provide additional time for rescue.

Mr. Roscioli was asked for information about the number of refuges sold, number and identity of any mines (coal and metal/nonmetal) where their refuges are located, instances where any refuges have been used, and requirements for maintenance of their refuge shelters. To date, no response to these questions has been obtained. However, based on initial interactions with ChemBio, it appears that they are new entrants into this market.

Manufacturability

ChemBio Shelters can easily be manufactured at a high production rate. We have designed the production process to minimize labor intensive requirements and to operate with as few processes and parts as possible. This minimizes the lead time for orders, even large orders, and increases the quality of the end product. For example, only a few necessary seams are made in the material. This is done by coordinating the material width requirements with the original equipment manufacturer.

We have outfitted one manufacturing facility with equipment to produce ChemBio Shelters. This plant is capable of producing 200 shelters per month.

We have identified and signed 5 year contracts with primary, secondary, and tertiary manufacturers of the equipment needed to produce ChemBio Shelters. In each case we have developed the equipment supply chain to support more than 200 shelters per month. Also, all of the equipment in any of the models and air processing options has been carefully selected to include only well established supply sources with many manufacturers. All chemicals are mass produced for other applications. The monitors are standard "off the shelf" items that are readily available.

The material can be mass produced with current manufacturing capability.

Trapped Miners Now Have Chance For Survival!

Mine Escape Planning &
Emergency Shelters Workshop

National Academy of Sciences

Washington, DC

April 18, 2006

Ed Roscioli, CEO
ChemBio Shelter, Inc.
www.ChemBioShelter.com





ChemBio
SHELTER

Life ShelterTM

...Saving The Lives of Trapped Miners

ChemBio *Life Shelter*TM - the most reliable, economical and technologically advanced way of providing a "Safe Haven".

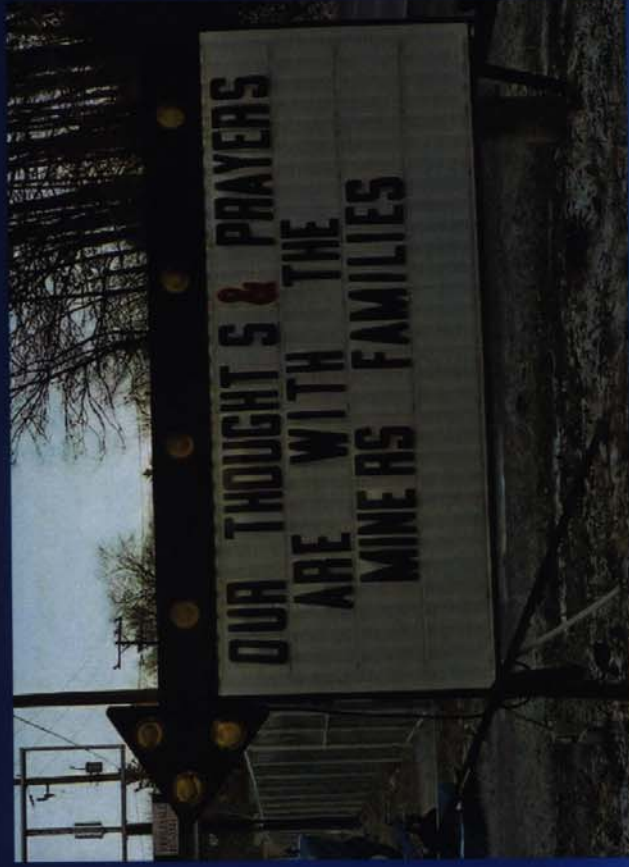

ChemBio
SHELTER





ChemBio
SHELTER

NEWS: ChemBio Shelter Partners With Industry Leading Emergency Shelter Manufacturer

- **Zumro, Inc., Hatboro, PA**
- **18 Years Experience**
- **Rugged Materials**
- **Soft-sided Construction**
- **Rapid, Air-Beam Deployment**
- **Design Flexibility**



Rugged

Soft-Sided



Air-Beam Deployed



Design Flexibility



NEWS: DoD Selects Allentown, PA Company For Assessment of Chemical, Biological and Radiological Protection System

- Joint Program Executive Office for Chemical and Biological Defense (JPEO-CBD)
- December 2005 – Extensive 5-day Test
- Collective Protection for Troops
- Simulated Chemical Agent Attack
- Flame Retardant
- Maintained Life-sustaining Environment
- Decontamination Unit
- Toxic Free Entry and Exit

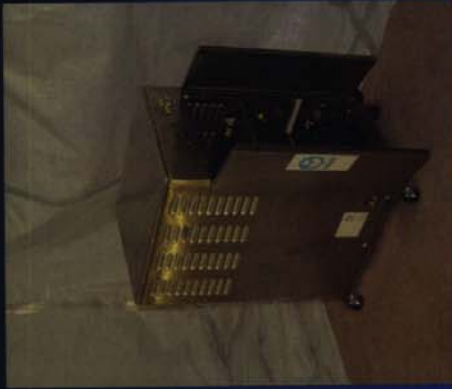

Portable Atmospheric Control Unit

Air Lock

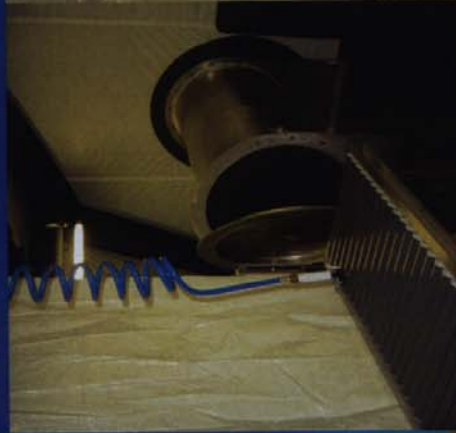

Water Lock





NEWS:

**ChemBio Shelter Demonstrates
Emergency Life Shelter at
Bruceeton Experimental Coal Mine**

February 8, 2006





The Mine Rescue Need

Ensuring miners have a life-sustaining air supply...

- When,
- Where, and for
- How Long they need it!



Mine Emergency Situations

- Explosion
- Fire
- Collapse
- Contaminated Air

Miners Unable To Exit Mine





The Solution: Life Shelter™

- Rapid Deployment
(Less than 60 seconds)

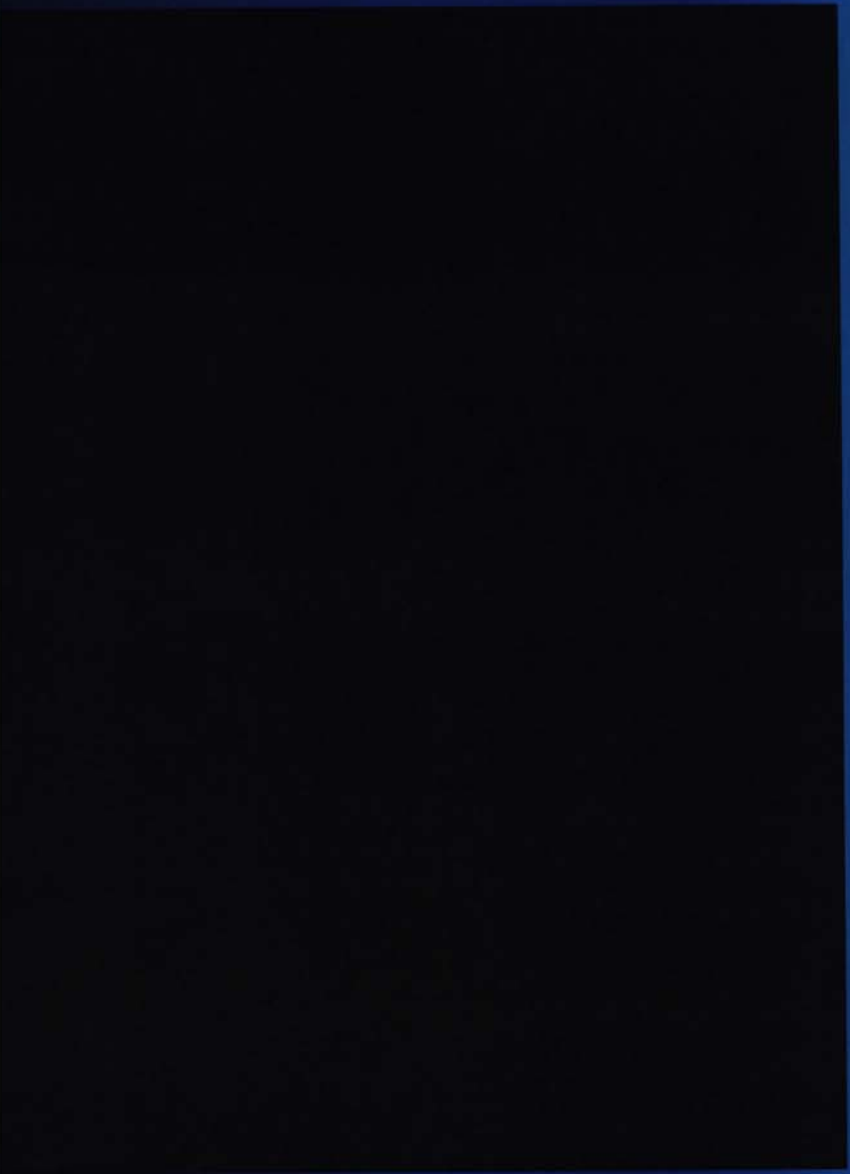



ChemBio
SHELTER

The Solution: Life Shelter™

- Ease of Operation
- Durability
 - Flame Retardant (meets UL94-V0)
 - Puncture & Tear Resistant
- Availability

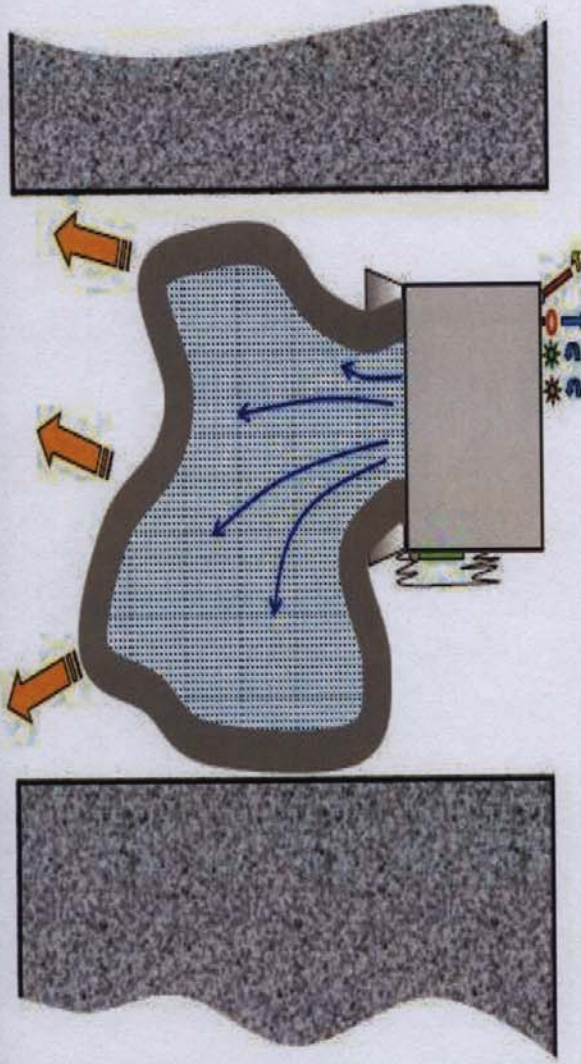

Deployment Sequence

1. Open Panel & Pull Release
2. Open Valve 1
(deploy & fills shelter with fresh air)
3. Open Valve 2
(lifts shelter to available height automatically)



ChemBio
SHELTER

The Need: Where

- Low seam / high seam
- Accessible by all workers
- Within 1000 feet of active workings
- Inby / Outby placement





ChemBio
SHELTER

The Solution: Life Shelter™

Mobile

- Skid Mounted

Sizes

- 20" to 36"
- 36" to 60"
- 84"
- Custom

Capacity

- Up to 18 workers

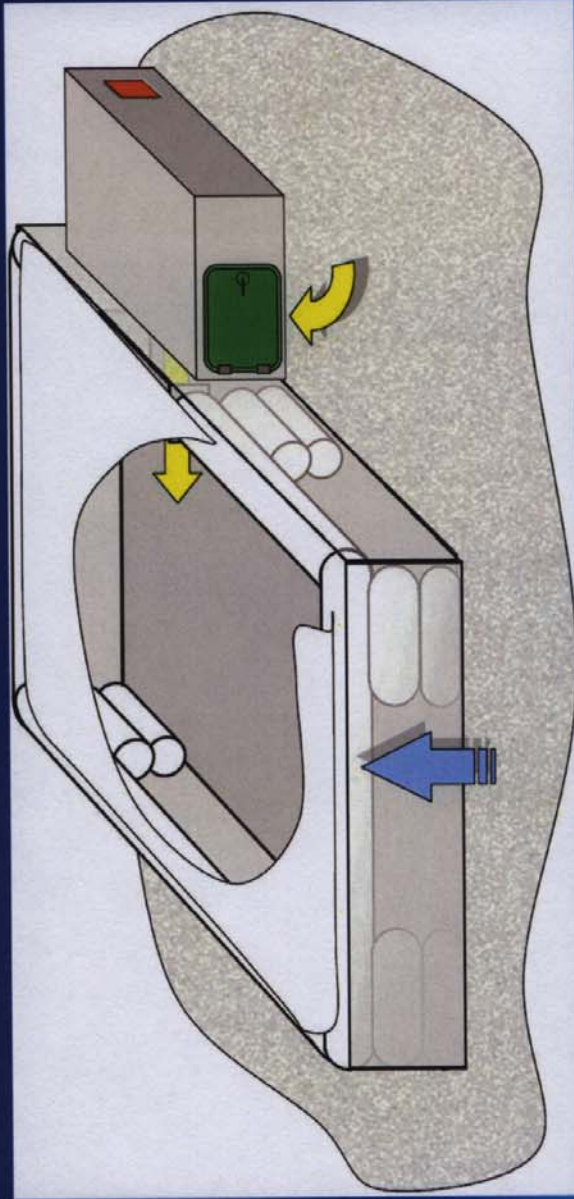

Duration of Emergency

- Contaminated Mine Air
- Rescue Team Arrives

Shelter Design

- Duration of life-sustaining air supply
 - Monitoring air
 - Power requirements
- Shelf-life of equipment & supplies





The Solution: Life Shelter™

Life-sustaining air supply

- 96 hours of protection (or more)
- No external power required
- Air-lock entry system
- Positive pressure

Shelf-life: Equipment

- Shelter (20 yrs)
- Monitors (2 yrs)

Shelf-life: Supplies

- Oxygen candles (10 yrs)
- CO₂ scrubbing (5 yrs)
- CO scrubbing (10 yrs)
- Activated carbon filter (5 yrs)





ChemBio
SHELTER

Life Shelter™ Standard Package

Air-beam deployed, hermetically sealed shelter

- Protects up to 18 people
- Easily stored and moved
- Rapidly deployed
- Air lock for safe entry
- Field repair kit
- Emergency lighting

Air-processing system

(operates without external power)

- Oxygen reactor
- CO₂ scrubber
- CO scrubber

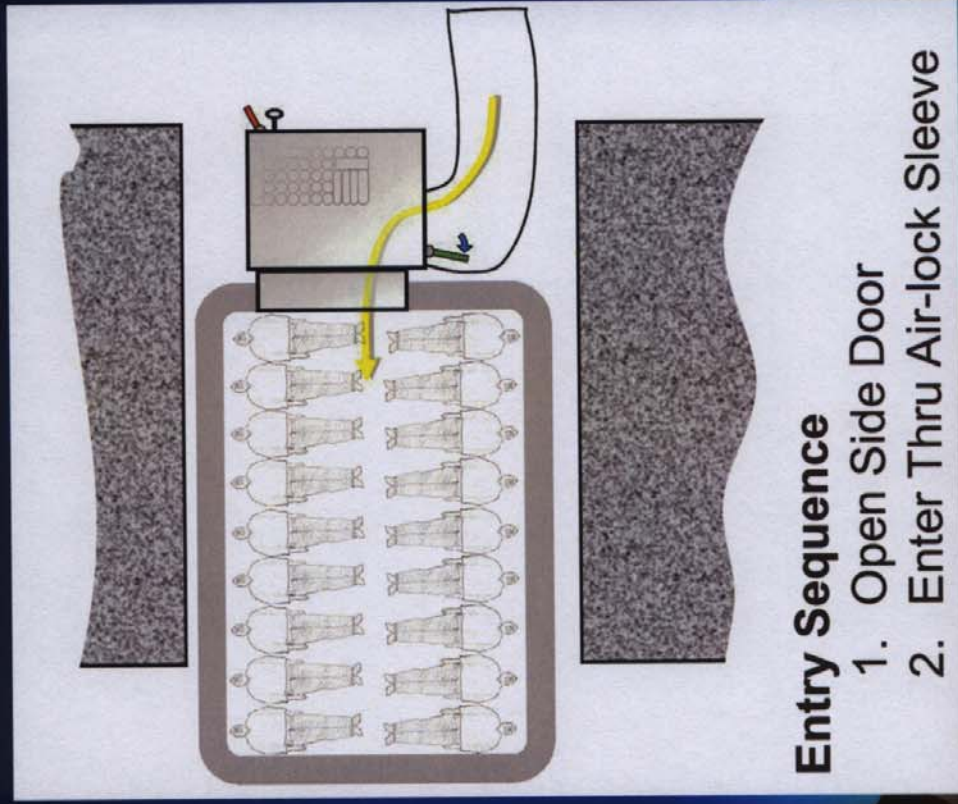

Entry Sequence

1. Open Side Door
2. Enter Thru Air-lock Sleeve



ChemBio
SHELTER

Life Shelter™ Standard Package

Monitors

- Oxygen, CO, CO₂ & temperature
- Intrinsically safe
- Inside / outside monitoring

Consumables

- Oxygen reactor cartridges
- CO₂ absorbent
- Activated carbon filters
- Emergency medical supply kit
- Pre-packaged Meals
- Potable Water
- Chemical Toilet Packs

CO₂ Monitor



CO Monitor



Oxygen Monitor





ChemBio
SHELTER

Summary



- Long Term Air Supply
- Mobile
- Rapid Deployment
- Air Processing without Electrical Power
- Tough Material and Storage Cart
- Standard and Custom Sizes
- Availability





Life Shelter™

...Protecting You In An Uncertain World.



Thank You
For Your
Interest!

ChemBio Shelter, Inc.
968 Postal Rd
Suite 320
Allentown, PA 18109
800-344-6275

www.ChemBioShelter.com

Revolutionary Emergency Shelter Ensures Miners' Life-Sustaining Air Supply

ChemBio Mine Refuge Shelter

Safe Haven—Revolutionary and ruggedly constructed, the ChemBio Mine Refuge Shelter provides an impermeable barrier from the life-threatening concentrations of carbon monoxide and other toxic gases that are likely to be present in a mine emergency.

Long-term Air Supply—Engineered to provide a safe haven for up to 20 workers per unit, the patent-pending shelter system provides a life-sustaining supply of air for 96 hours, or more — without the need for any external power.

Rapid Deployment—The shelter's compactly-stored, rugged membrane uses air-beam technology for rapid deployment in emergency situations — when time is critical.

Rugged & Portable—Designed to tough military standards*, the self-contained system is stored in a skid-mounted, heavy gauge steel storage container that can be strategically positioned within the mine (e.g., in a crosscut near the working face).

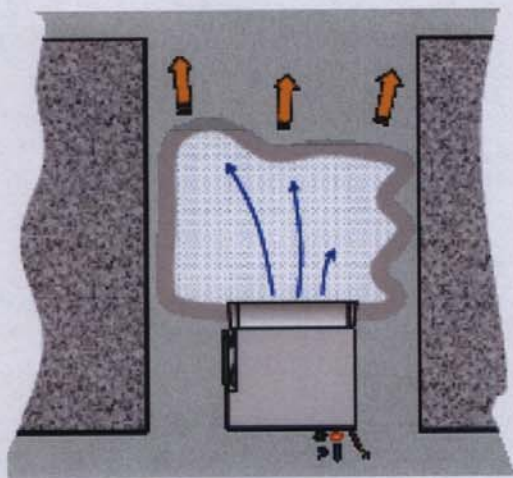

In case of an emergency, mine workers can deploy the system within minutes, using three simple steps to:

1. Open the access door
2. Deploy the base
3. Deploy the shelter

Inside, the patent-pending air-processing system maintains a breathable air supply by maintaining oxygen levels and scrubbing carbon dioxide and carbon monoxide from the air.

The ChemBio Mine Refuge Shelter comes in several standard configurations. Custom sizing is available.

**ChemBio's shelter technology has been proven effective for protection against lethal chemical and biological warfare agents in extensive military testing.*

Container-deployed System



Air-beam Technology

The container-deployed system comes complete with air-beam shelter module, air-processing equipment, chemicals, monitors, emergency lighting, potable water containers, meals-ready-to-eat, heavy-duty repair kit, chemical toilet and medical supplies (EMS kit).

FOR ADDITIONAL INFORMATION

ChemBio Shelter, Inc.
968 Postal Rd., Suite 320
Allentown, PA 18109

Phone: 610-266-6667
Fax: 610-266-6575

Email: Service@ChemBioShelter.com

FOR IMMEDIATE RELEASE:
October 09, 2006

Contact: Scott Cass
1-800-344-6275

Innovative Mine Refuge Shelter To Be Featured In MSHA Simulated Mine Emergency

Allentown, PA. - ChemBio Shelter announced today that its revolutionary emergency shelter system will be featured in the simulated mine emergency exercise at the annual Training Resources Applied to Mining (TRAM) Conference Oct. 10 to 12. The conference is conducted by The U.S. Department of Labor's Mine Safety and Health Administration (MSHA) at the National Mine Health and Safety Academy in Beaver, W.Va. MSHA expects more than 500 people may attend, making it the largest ever TRAM conference.

During emergency situations, miners' lives depend on surviving in a deadly carbon monoxide environment, until they are rescued. Ed Roscioli, a nuclear engineer and CEO of ChemBio Shelter, Inc. stated, "We create the environment where miners can sustain themselves, separated from these life-threatening gases until rescue teams are able to reach them."

The ChemBio Shelter system was originally created to protect civilian and military personnel in the event of chemical or biological attack. "We're delighted to have had the opportunity to work with two first-class organizations, ChemBio Shelter and Zumro, in adapting this unique sheltering system to the mining industry," said Leonard Urtsso, President of A.L. Lee.

The complete system - shelter, equipment and supplies - is stored in a hermetically-sealed steel container that is mounted on a skid for portability. The steel container ensures the contents are protected while in storage. The self-contained system can be strategically pre-positioned in a mine crosscut near the working face. In case of an emergency, miners who can't escape can deploy the system in minutes. Once inside, they operate the air-processing system to maintain a breathable air supply, for up to 96 hours.

Win VanBasten, President of ZUMRO[®], stated, "It's an honor to have been invited by MSHA to participate in this demonstration, but even more gratifying to know that we can save lives."

A.L. Lee (www.ALleeCorp.com) has been designing and manufacturing mining equipment since 1967. In that time, they have designed over 4,500 machines for underground mines, including Utility Vehicles, Personnel Carriers and Rockdusters. Their products are built to meet the demanding requirements of the underground mine environment.

ChemBio Shelter, Inc. (www.ChemBioShelter.com) began development of emergency refuge shelters in response to military and civilian needs for protection from life-threatening chemical and biological warfare agents following the terrorist attacks of September 11, 2001. ChemBio's shelter technology has been proven effective for protection against lethal chemical and biological warfare agents in extensive military testing. Their emergency mine shelters are engineered to the same rigorous standards.

ZUMRO[®] Inc. (www.zumro.com) has been building "Inflatable Shelters" since 1987. The original "Decon Shelter" with the unique external frame and field-replaceable canopy is now complimented by a full line of "Emergency Shelters." The Emergency Shelters filled the demand for larger and stronger shelters. ZUMRO[®] Air-Shelters offer instant, on-the-scene shelters for any type of operation and are in service globally with Fire-Rescue, Law Enforcement, Hospitals, U.S. Army, Navy, Air Force, Marines, Secret Service and Industry.

For more information, contact:

Scott Cass
1-800-344-6275
ESCass@ChemBioShelter.com

ChemBio Shelter, Inc.
968 Postal Rd., Suite 320
Allentown, PA 18109

ChemBio

ChemBio offers MRE's. See more information on this product under "Related Equipment."

COWAN

Cowan Manufacturing Pty Ltd

Information about the mine refuges manufactured by Cowan Manufacturing Pty Ltd (Cowan) was obtained from various internet sources (including their web page) and by contacting them directly. Cowan manufactures steel pre-fabricated stand-alone portable mine refuges. Information obtained from internet sources is attached.

Tim Owen, the Cowan representative contacted, was asked for information about the number of refuges sold, number and identity of any mines (coal and metal/nonmetal) where their refuges are located, instances where any refuges have been used, and requirements for maintenance of their refuge shelters. The following provides a summary of the information he provided in response to this inquiry.

According to Mr. Owen, Cowan began manufacturing mine refuges in New South Wales, Australia 7 years ago under a research and development contract with the Australian Mining Industry. They currently have six chambers placed in gold mines in Australia. None of the refuge chambers have ever been used during an emergency.

Mr. Owen indicated that they design their units from steel to "allow handling, and if necessary dragging, by mine equipment. The units were also designed to resist a significant air blast although definitive testing and analysis was not developed." Maintenance schedule includes a regular visual unit/systems integrity check and a 6 month operational/functional check of systems.



Mine Fresh Air Base



Overview

- Description of the Fresh Air Base
- Functional Descriptions of Equipment
- Operations: Controls and Systems

Roof in Low Position



MSU Transport

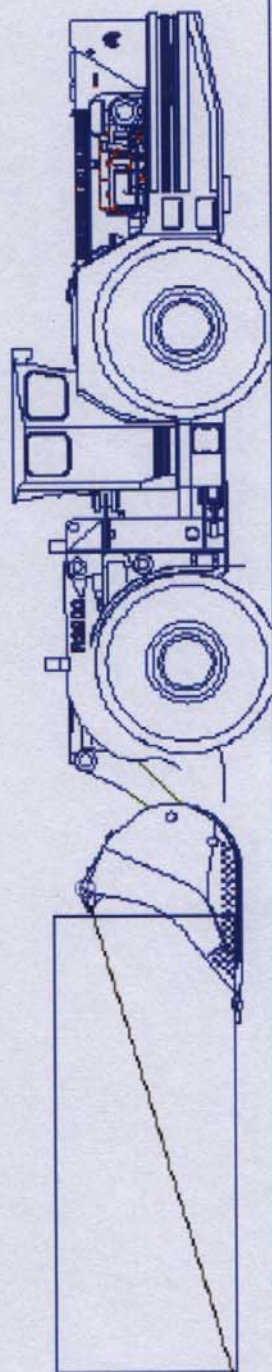

x

Interior - Main Chamber



Roof Lifting Strut & CO2 Scrubber



Freezer Unit

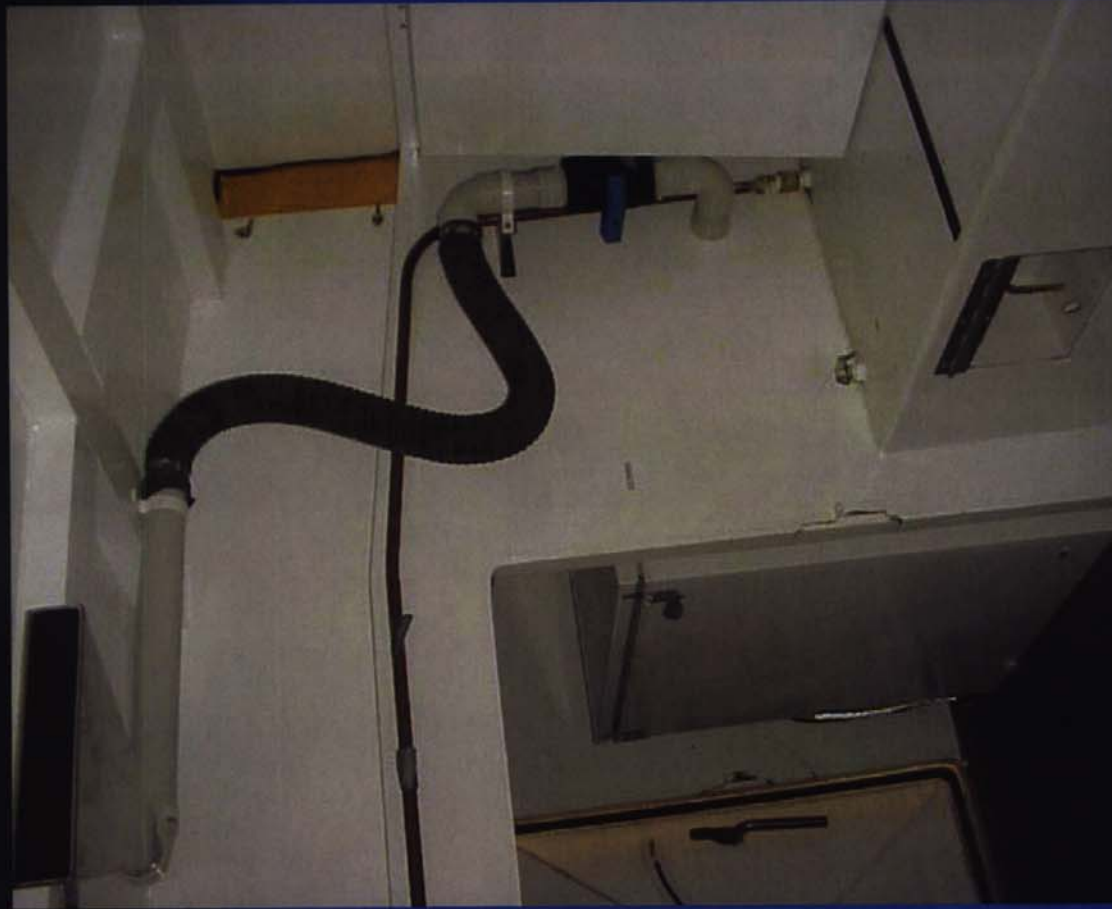

With Cold
Air Outlet
into Main
Chamber

Gas Supply



- G size bottles - 5 in Main and 2 in Entry compartments
- Controlled discharge via panels and piping

Air Supply



External Air Connection

Air Supply

Entry Compartment
Air Curtain

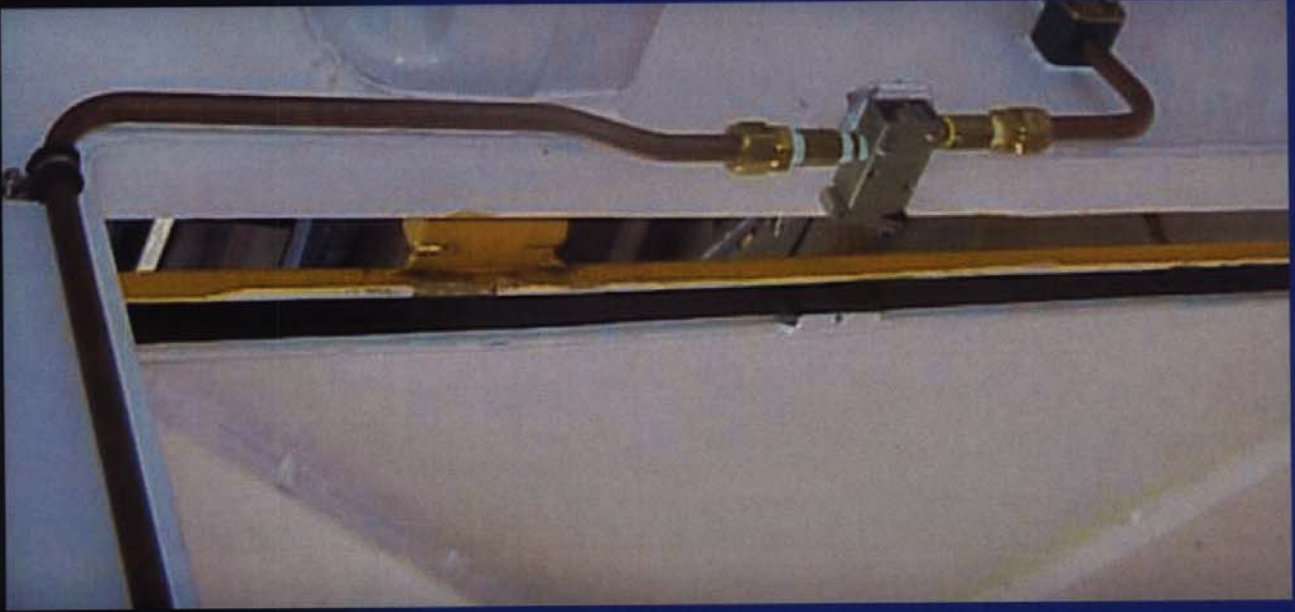
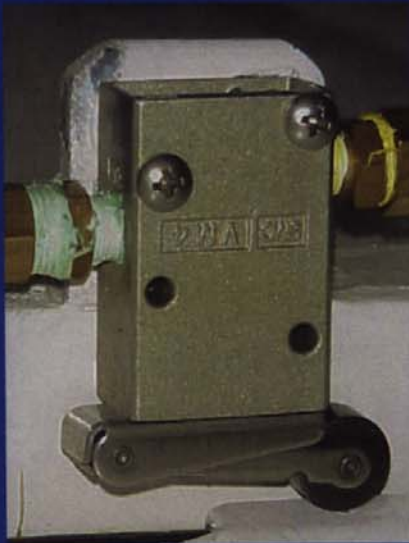

Air Supply

External Air Valve and Relief System

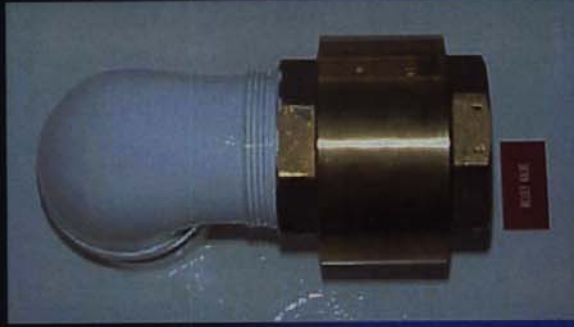

Oxygen Supply

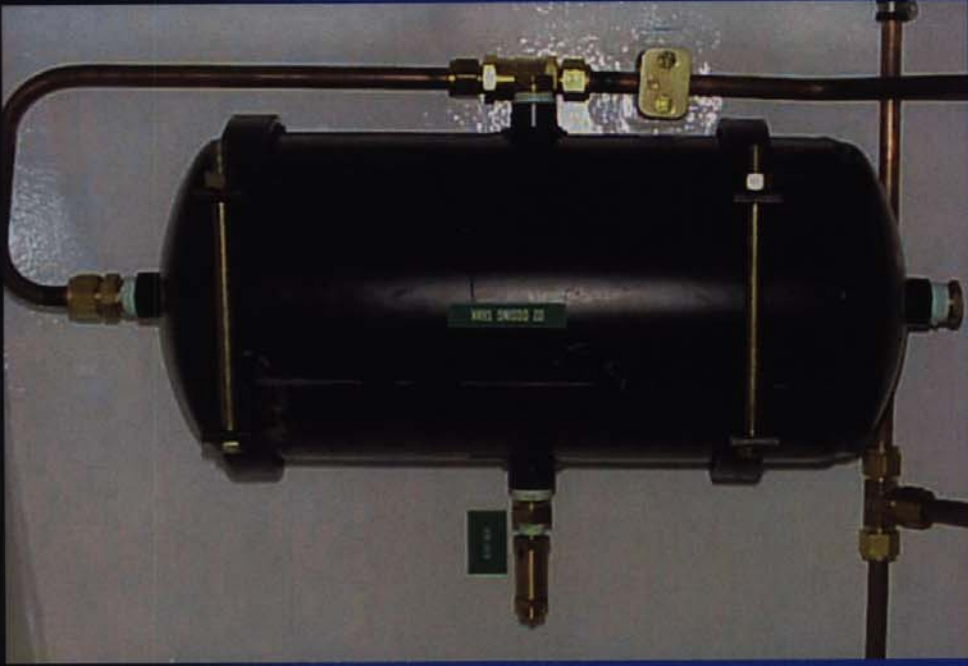

Oxygen Dosing Tank

CO2 Scrubber

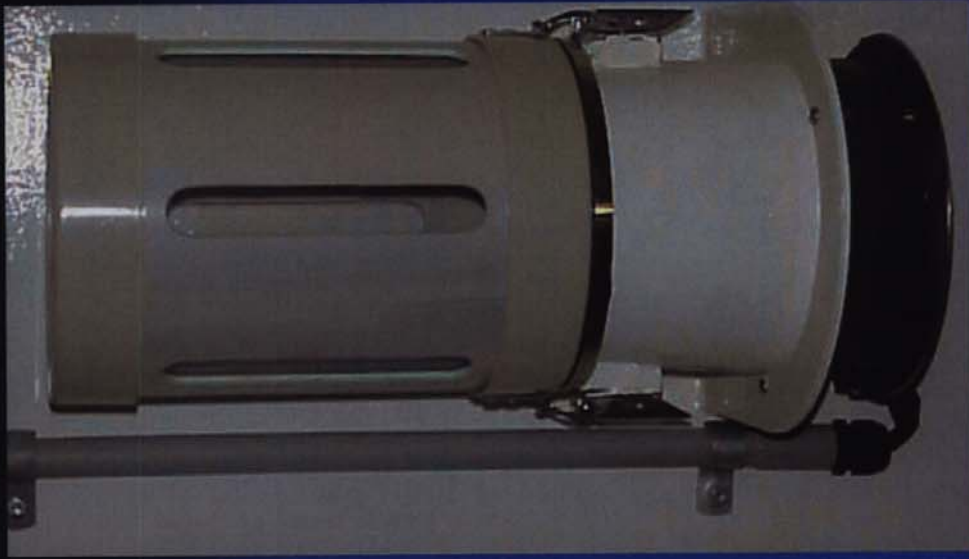

Carbon Dioxide Scrubber Unit

Access

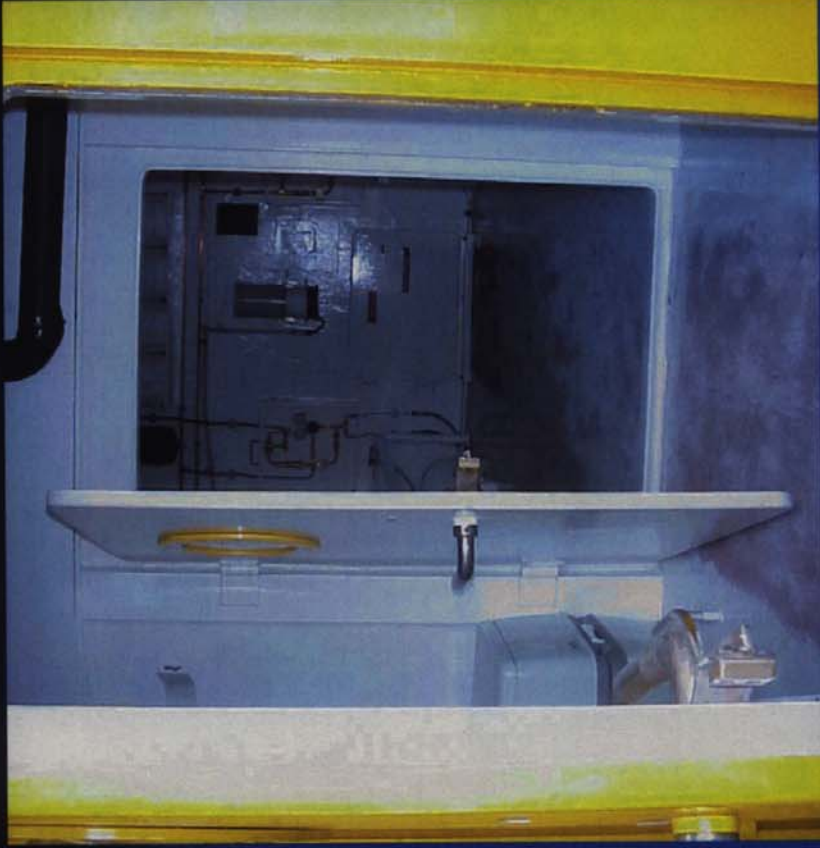

Main, Internal and Emergency Doors
Double Lock Compartment

Air Circulation



Air Circulation Fan & Control Valve

Facilities

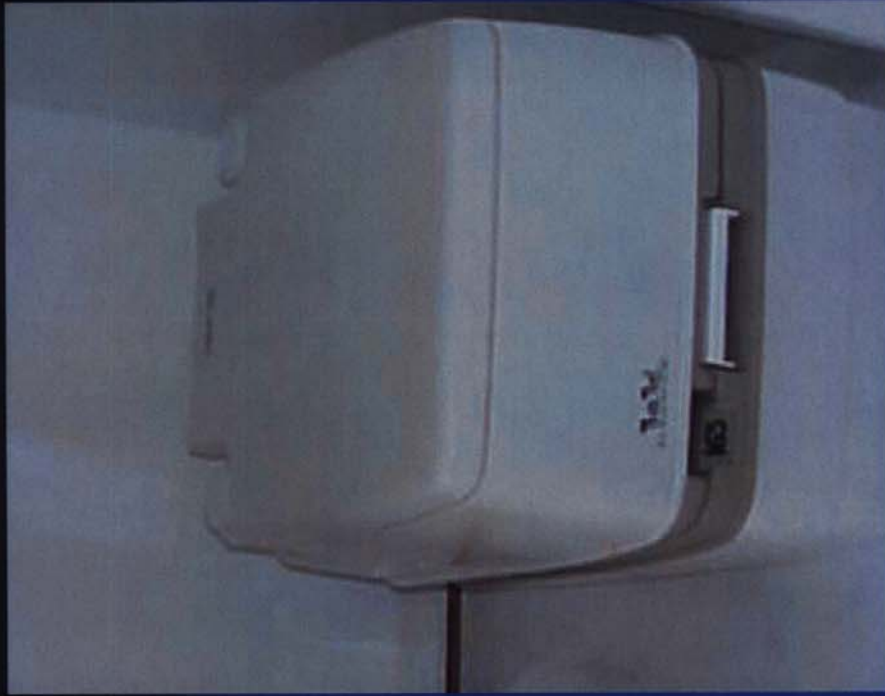

Chemical Toilet

Facilities

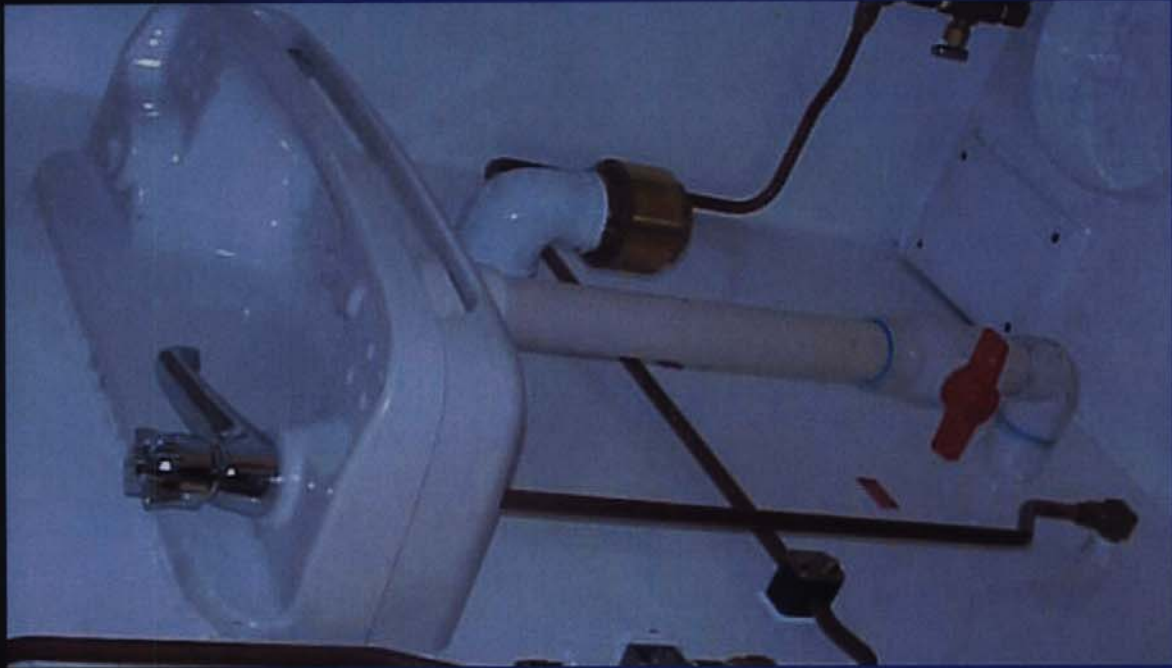

Washbasin

System Operations and Checks: CO2 Removal

- 2 scrubbers powered by on board batteries
- 24 hour capacity
- Canisters requires periodic (approx 2 hrs) change out

System Operations and Checks: Electrical System

- External 240VAC with single isolator inside compartment
- 2 internal power outlets (charger + 1 spare)
- 12VDC float charge to 3 x 102 AH batteries, 24 hour power capacity for fans
- Batteries stored on shelf in Entry Compartment

*System Operations and Checks:
Charger & Batteries*



Current Designs

- Extend Time to 90 Mandays
- Evaluating Alternative Power Units
- Increase Pulse Loading

Questions



COWAN 12 PERSON MINE REFUGE CHAMBER



TECHNICAL SUMMARY – other options available

CONSTRUCTION

Heavy Duty Chamber Construction – designed for handling by Mine Equipment

Skid Mounted with fork lift, lashing and lifting points

Weight: 6 tons gross weight excluding personnel.

Size: 5.8m length x 2.3m width x 2.0m height

Two compartments with outer and inner doors.

Main Compartment Emergency Escape Hatch

Doors fitted with windows

CAPACITY/ ENDURANCE

Base unit provides life support for 12 persons for a period of 24 hr, with model variants providing 2 day, 4 day and 7 day duration for 12 persons

Seating / bunks for 12 persons in Main Compartment providing comfort during extended stays.

ATMOSPHERE CONTROL

Two Compartments – Positive pressure compartments and Entry (Air) Lock environments to exclude contaminated air.

Optional Air curtain for Main Door to exclude contaminated air

Integral Air supply / Flushing System comprising 4 in No. G size HP Air cylinders

Carbon Dioxide Scrubbing System

Atmosphere Monitoring System monitoring Oxygen, Carbon Monoxide, Carbon Dioxide and Methane levels both within each compartment and outside the chamber. Real time monitoring and alarm indication.

Integral Oxygen Supply/ Generation System- various options available utilising Gaseous Oxygen and/ or Oxygen Generation Technology.

Environment Cooling System – split system air conditioning system

GENERAL FIT OUT

Entry Lock Compartment with support equipment / systems
Sanitary System c/w toilet, wash basin, water tank and holding tank
500 litre / 132 gallon Drinking Water Storage Tank
Storage Facilities for Food, personal items and support equipment.
Waste storage unit

POWER SUPPLY

Facility for connecting Mine 480 VAC 3 phase supply or switching to Integral Emergency battery supply
24VDC Power Battery System comprising Gel type VRLA batteries
Battery charging system incorporating power management system and battery condition monitoring.
Battery back up provides full power requirements for the stated duration options.
Battery powered Inverter system provides 115 VAC power for air conditioning system and instrumentation.

LIGHTING

Low Power Lighting System – Low voltage sealed LED light modules with dimmer controls
External strobe and main door lighting.

OPTIONS

Fire Suppression Equipment
Phone Communications – wired and sound powered communications options available

1 2 3 4 5 6 7 8

5750

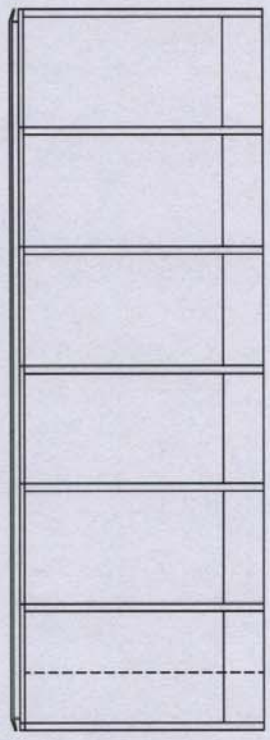
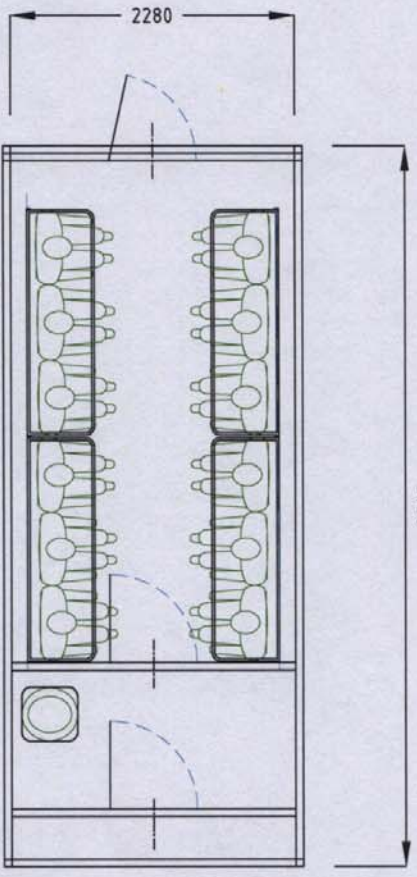

- GENERAL SPECIFICATIONS**
- CAPACITY: 12 persons
 - ENDURANCE: OPTIONS AVAILABLE FOR UP TO 7 days
 - ENTRY AIR LOCK
 - POSITIVE PRESSURE ENVIRONMENT
 - ENVIRONMENT CONTROL: OXYGEN MAKE UP AND CO2 SCRUBBING
 - MAINS POWER & BATTERY BACK UP SYSTEM
 - ATMOSPHERE MONITORING - OXYGEN, CO, CO2 and METHANE
 - INTERNAL AND EXTERNAL ATMOSPHERE SAMPLING
 - DRINKING WATER AND SANITARY SYSTEMS
 - FOLD DOWN BUNKS
 - EMERGENCY EGRESS DOOR
 - INTERNAL AND EXTERNAL LIGHTING

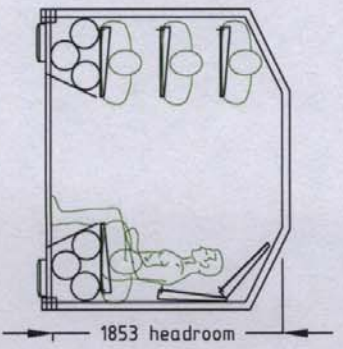
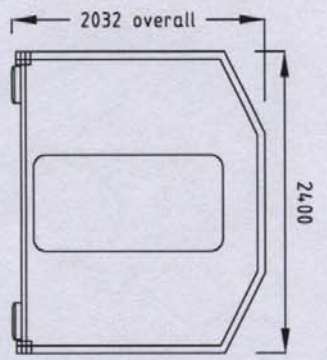

COWAN MANUFACTURING
 9A Weber St, Werribee, VIC 3039 AUSTRALIA
 Ph +61 3 9324 6584 Fax +61 3 9324 5732

Confidential and Proprietary Information
 Not for use, disclosure or copying except
 under conditions of Cowan Manufacturing Pty Ltd
 Document reproduction processes and permissions

DRAWN	TWO	DATE	TITLE
CREATED	CV	DATE	12 PERSON HINE REFUGE UNIT
APPROVED		DATE	

TITLE
 12 PERSON HINE REFUGE UNIT

DRAWING NUMBER
 Q7640

1 2 3 4 5 6 7 8

[[Home](#)] [[About](#)] [[Mine Safety](#)] [[Recompression Chambers](#)] [[Specialised Cleaning](#)]
 [[General Fabrication](#)] [[Specialist Welding](#)] [[Product Support](#)] [[Videos](#)] [[Links](#)]



UNDERGROUND RESCUE CHAMBERS

Protecting underground workers from
noxious gasses - in a crisis situation

The key objective is to sustain life, without
services such as air supply, water or power.



Underground Rescue Chambers

COWAN



Rescue Chamber designed specifically for
metalliferous mine applications

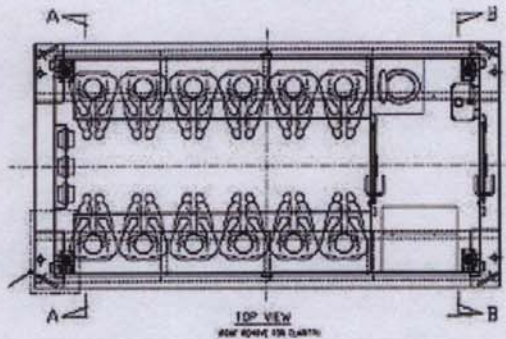

Key features/options include:

- Two compartments
- Seating
- Lifting & solid roof
- Design - easily adaptable to specific needs
- Underground transport skids
- Operates under positive pressure
- Robust steel construction
- Other construction materials
- Communications
- Rear safety exit
- Entry door air shower
- Controlled internal environment (temperature, humidity, CO2 & O2)
- Environmental monitoring
- Lighting
- Internal storage capacity
- Hand basin

- Chemical toilet

 **Spare Parts & Information Request Form**

COWAN

Tunnelling Refuge Chambers



Rescue Chamber designed specifically for underground tunnelling operation



Key features/options include:

- Seating
- Design - easily adaptable to specific needs
- Underground transport skids
- Operates under positive pressure
- Communications
- Safety exit
- Controlled internal environment (temperature, humidity, CO2 & O2)
- Environmental monitoring
- Lighting
- Internal storage capacity
- Hand basin
- Chemical toilet

 **Spare Parts & Information Request Form**

COWAN

Tunnel Boring Manlock

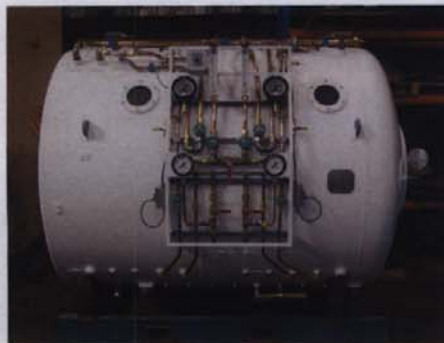

Leighton - Kumagai Joint Venture Tunnel Boring Machine

Cowan's TBM Manlock as shown (top) and attached to the Tunnel Boring Machine (below).

Used by Leighton - Kumagai Joint Venture on the New MetroRail City Project, the inner city component of works for the Southern Suburbs

Railway that will extend from Perth to
Mandurah



DRAEGER

Draeger Safety AG & Company

Draeger Safety AG & Company (Draeger) manufactures escape shelters (refuge chambers) for use in mining, tunneling, and offshore platforms. They produce sealable steel chambers specifically designed for the mining industry and will customize the design of their chambers to fit the specific needs of the customer. Draeger escape shelter information was obtained from available secondary sources, the Draeger webpage, and primary contacts. Copies of information obtained are provided in this section.

Draeger indicated that TJ Pitzer was the contact in the US for their escape shelters. Mr. Pitzer indicated that the information provided on the web page provided a good summary of their shelters. Additional attempts to contact Mr. Pitzer were made to obtain information about the number of refuges sold, number and identity of any mines (coal and metal/nonmetal) where their refuges are located, instances where any refuges have been used, and requirements for maintenance of their refuge shelters. To date, Mr. Pitzer has not responded to these attempts. If additional information is obtained, the NTTCC will forward this to NIOSH.

DRAEGER ESCAPE SHELTERS



DRÄGER SAFETY SYSTEMS • REFUGE SHELTERS for MINING
April 2006

Drägersafety

ESCAPE SOLUTIONS APPLICATION OVERVIEW

SHELTERS FOR OFF-
SHORE PLATFORMS



RESCUE RAIL VEHICLE FOR TUNNELS



RESCUE TRAINS FOR
RAILWAY TUNNELS

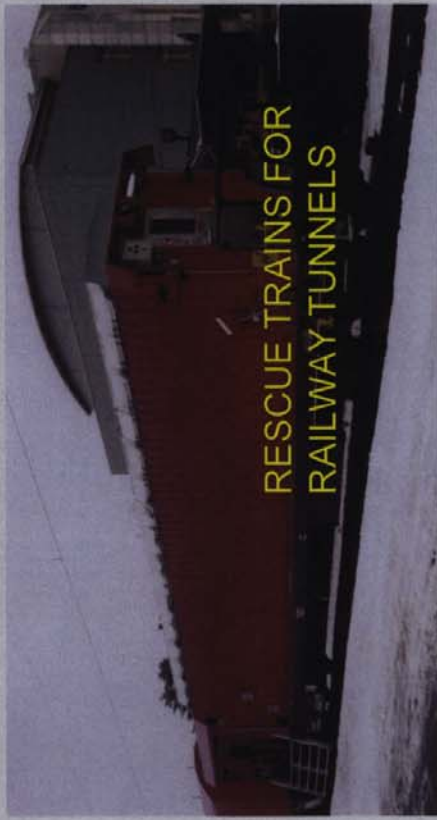

SHELTERS FOR MINING

DRÄGER SAFETY SYSTEMS • REFUGE SHELTERS for MINING
April 2006

Drägersafety

SHELTER SOLUTIONS for MINING and TUNNELING



....CUSTOM
SOLUTIONS

DRÄGER SAFETY SYSTEMS • REFUGE SHELTERS for MINING
April 2006

Drägersafety



SHELTER SOLUTIONS for MINING and TUNNELING



...MORE EXAMPLES

DRÄGER SAFETY SYSTEMS • REFUGE SHELTERS for MINING
April 2006

Drägersafety

ESCAPE SHELTERS PROTECTION PRINCIPAL

Refuge shelters designed by Draeger offer protection to the users by creating a respirable atmosphere inside an enclosed space.

Protection is ensured by:

- Maintaining the **Oxygen level** in the range $19\% \text{vol} > \text{O}_2 > 22\% \text{vol}$
- Maintaining the **Carbon Dioxide level** $\text{CO}_2 < 1\% \text{vol}$
- Creating an **overpressurized atmosphere** inside the shelter

The shelters are designed for protecting a certain number of people for a certain length of time.

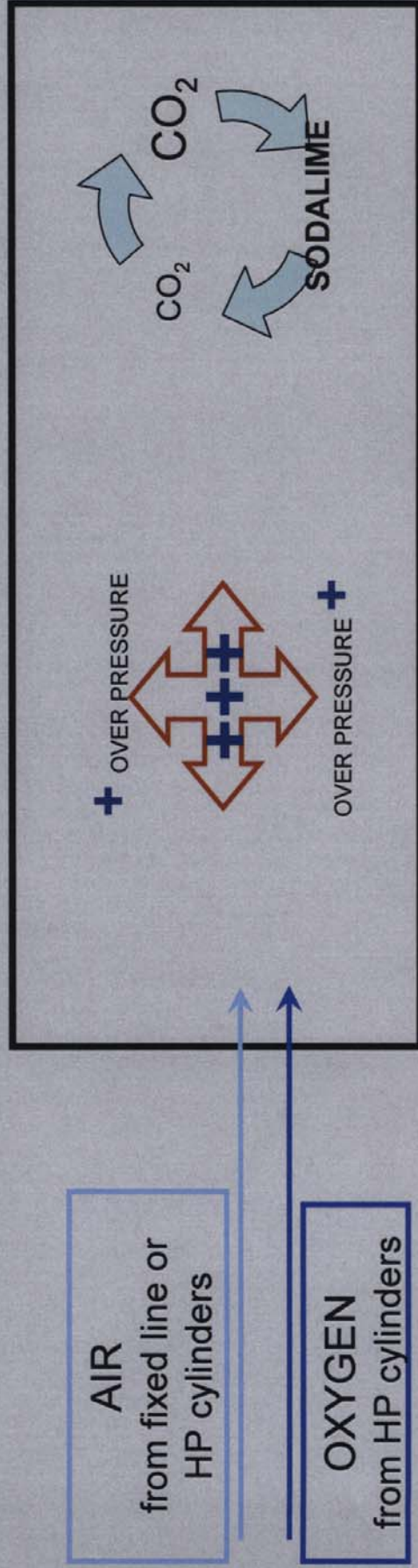

ESCAPE SHELTERS FOR MINING GENERAL FEATURES



- CO2 scrubber
- Oxygen Supply
- Breathing Air supply
- Air Conditioning
- Alarm/Siren
- Overpressure valves



- Gas tight doors
- External Air Supply
- External Elect. Power
- Battery power supply
- Standard & Emergency Lighting

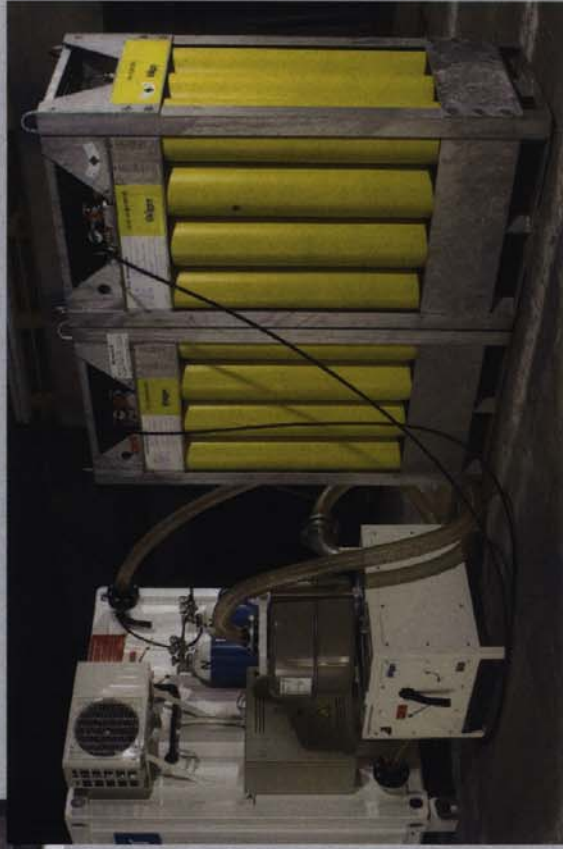

ESCAPE SHELTERS FOR MINING CO2 scrubber – 20ft container type 20 persons for 24 hours



Spare CO2
cartridges

- CO2 Scrubber installed under bench
- Efficient twin blower design
 - designed for emergency battery operation
 - soda lime in cartridges for quick exchange

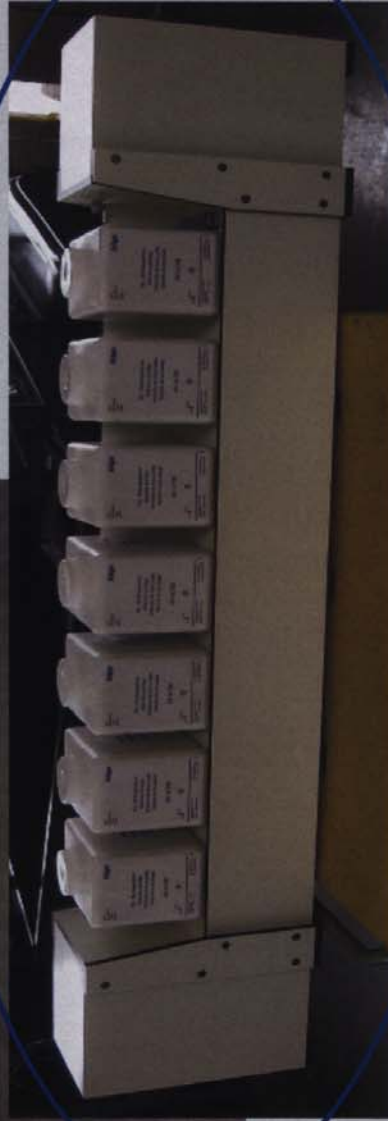

ESCAPE SHELTERS FOR MINING FEATURES (INSIDE) – 20ft container type 20 persons for 24 hours

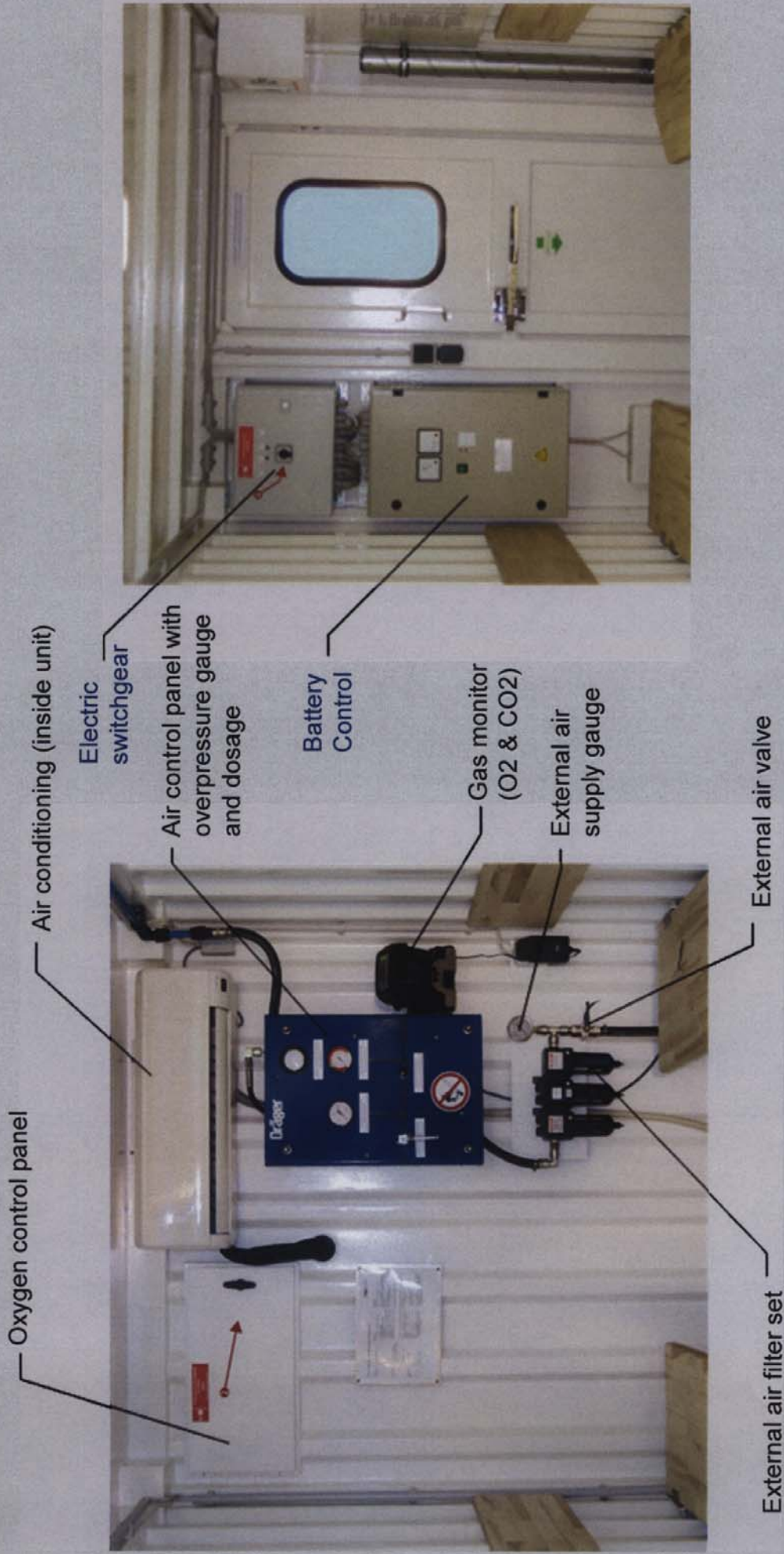

ESCAPE SHELTERS FOR MINING

Room equipment – 20ft container type 20 persons for 24 hours



- Chemical toilette
- Maps of emergency evacuation routes
- Food and Water
- First Aid equipment
- Additional breathing devices
- Portable gas monitors

Other available **OPTIONS**



- PRESSURE EQUALIZATION DEVICE**
 - *for use in Blasting Environments*
- AIR CURTAIN**
 - *for entry protection*
- COMMUNICATION SYSTEM**
 - *for two-way communication*
- STRETCHER/GURNEY**
 - *for handling injured persons*



ESCAPE SHELTERS FOR MINING

Escape Shelters can be designed to a required specification according to site conditions

- Smaller shelters for low seam heights
- Shelters on skids or wheels for transportability
- Inflatable shelters
- Stand alone life support systems for built-in shelters



ESCAPE SHELTERS for MINING

Shelter KIT

Life support system for 10 persons for 12 hours

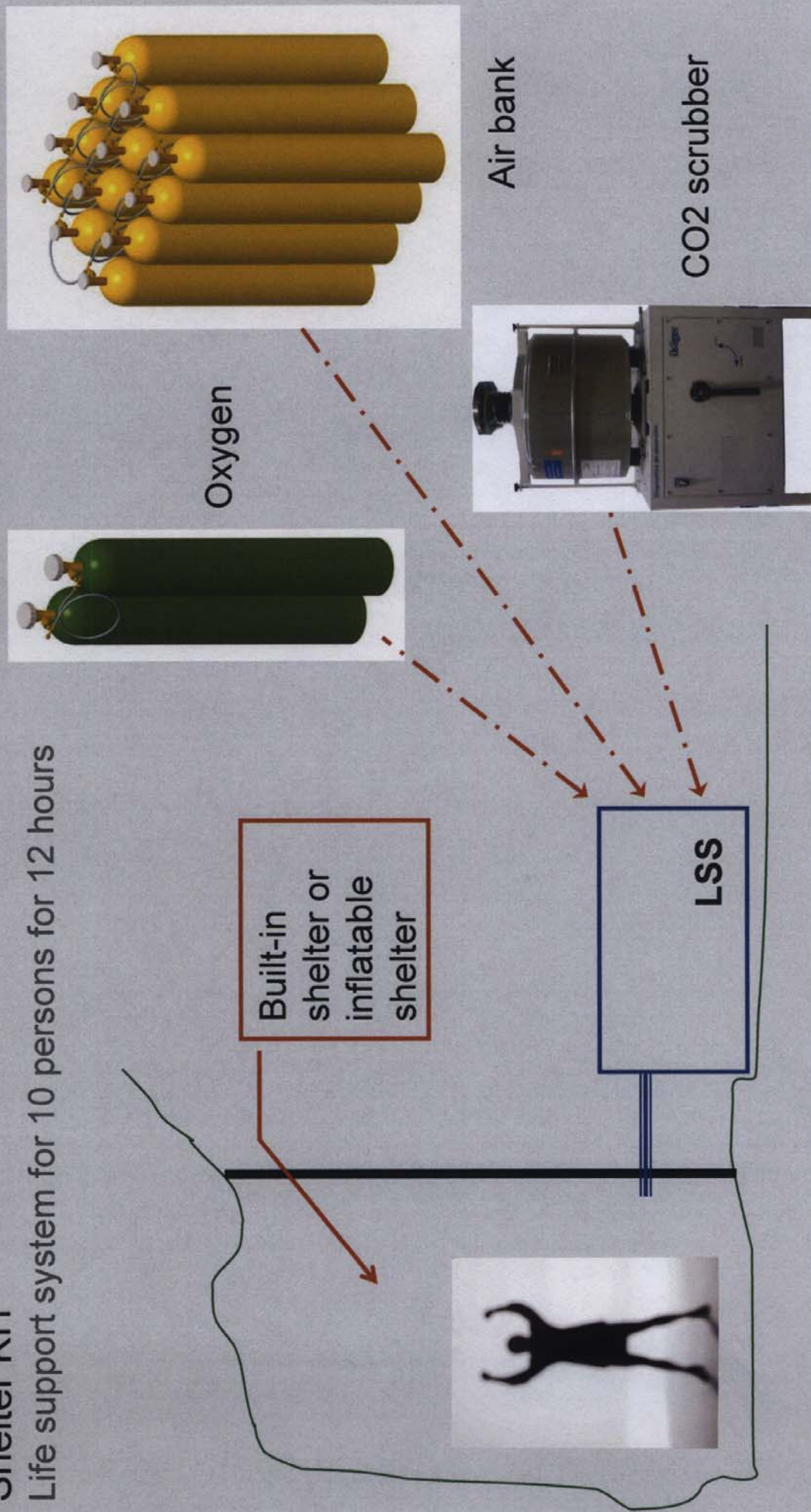

Oxygen

Air bank

CO2 scrubber

LSS

ESCAPE SHELTERS FOR MINING

Modifications necessary to current designs will be driven by MSHA & mining industry recommendations

Modifications- special requirements for the coal mines

- MSHA approved components and parts
- Electrical equipment – Intrinsically safe, explosion proof
- Fire resistant materials, insulation
- Training programs
- Other modifications?



THANK YOU FOR YOUR ATTENTION!

DRÄGER SAFETY SYSTEMS • REFUGE SHELTERS for MINING
April 2006

Drägersafety

Drägersafety

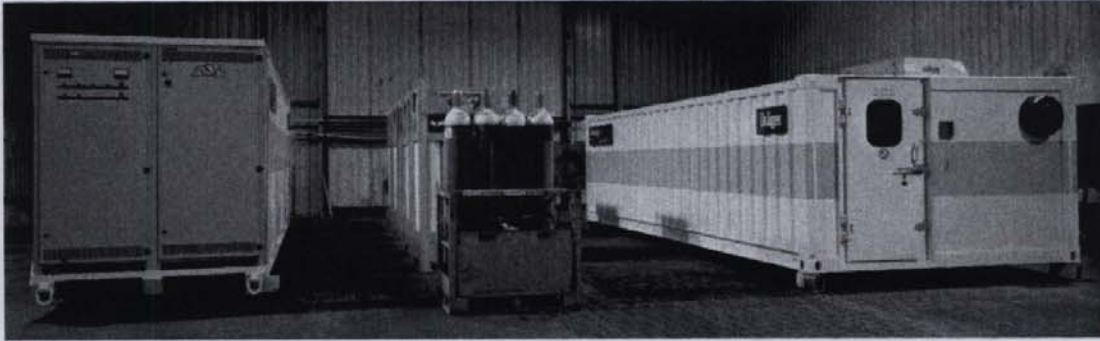

SPECIFICATIONS

Refuge Shelter

model

DSSI RS24-15

Accommodates 15 people, with independent life support up to 24 hours

© Draeger Safety, Inc. 2006

The information which is contained in this document is the property of Draeger Safety, Inc. and Dräger Safety AG & Co. KGaA. The contents of the document must not be reproduced or disclosed wholly or in part or used for purposes other than that for which it has been supplied, without the prior written permission of Draeger Safety, Inc. or, if it has been furnished under a contract with another party, as expressly authorized under the contract. Draeger Safety, Inc. and Dräger Safety AG & Co. KGaA shall not be liable for any errors or omissions.

Draeger Safety, Inc., Breathing Gas Systems
101 Technology Drive • Pittsburgh, PA 15275
☎ (412) 787-8383 • Telefax (412) 787-2207

SPECIFICATIONS

Drägersafety

Refuge Shelter model DSSI RS24-15

June 26
Page 2

Intended use

The **Dräger Refuge Shelter or Escape Chamber** is specially designed for use in mining and tunneling operations to provide shelter for persons working underground in the event of a situation yielding a non-breathable atmosphere (IDLH atmosphere). This situation may develop for example in case of an explosion, fire, cave-in or other accident.

The escape chamber is designed to be easily transported and therefore always made available at the place of work. In an emergency the underground workers may isolate themselves from the IDLH atmosphere if the escape route is too long or blocked off and wait for rescue. The shelter is designed to be used in underground mines but NOT in a blasting environment which exposes the shelter to repeated air pressure shock waves. These systems are available upon request from **Dräger**.

The protection principle

The air inside the chamber is cooled, and exchanged through air-conditioning and atmosphere purging. A carbon dioxide scrubbing system is used to remove CO₂ from the chamber atmosphere. A separate pure oxygen supply, supplements the oxygen consumed by the occupants. Over the whole period of use the chamber is pressurized with a slight positive pressure thus preventing contaminated air from entering. Further, the shelter is equipped with a man lock to minimize the ingress of smoke and toxic gases when persons enter and exit the shelter. This lock is kept smoke free by leading flushing air from the main chamber by a special arrangement of exhaust valves.

Cooling is an essential part of the life support system, especially over a longer period of time. Therefore, the air conditioner is equipped with a protective condenser filter to prevent blockage due to the dusty atmosphere outside the shelter. Provision is made for the occupants to clean this filter from inside the shelter.

The carbon dioxide scrubber is designed with two blower motors, so that in the event of failure of one motor, the other will still maintain the circulation through the scrubber material. An air distribution pipe work ensures efficient CO₂ removal. The soda lime is pre-packed into cartridges which have the advantage of being more homogeneously distributed minimizing dusting and channeling effects. Locating the scrubber and spare soda lime cartridges under the benches provide for a space saving solution.

The standard shelter is powered, using an externally supplied 120V AC source. In case of a loss of power the air-conditioning and CO₂ scrubber system is operated with battery power.

The shelter is designed to accommodate 15 people, and to provide these people with life support to last up to 24 hours independent of external electrical or air supply. Of course, if external services are available, the life support period is extended beyond this 24 hour period,

The standard shelter with a completely configured life support system will consist of the following,

SPECIFICATIONS

Drägersafety

Refuge Shelter model DSSI RS24-15

June 26
Page 3

- **Steel framed structure with man lock**
 - Gas tight doors
 - Escape hatch
 - Exhaust valves
 - Storage shelves
 - Air Conditioning system
 - Over pressure gauge
 - Gas Analyzer for O₂ and CO₂
- **Breathing Air Supply System**
 - Air storage bank & control panel
 - Oxygen supply cylinders with dosage control
- **Electrical System**
 - Battery backup system
 - Battery charging and control panel
 - Fluorescent lighting and wall outlets
 - Warning light and alarm
 - External power switch panel
- **CO₂ Scrubber System**
 - CO₂ Scrubber unit
 - CO₂ Scrubber cartridges
- **Room Equipment**
 - First Aid kit
 - Chemical toilet

In certain instances, a basic shelter may be installed with an air supply provided through an external air line. It will be designed with provisions for retrofitting life supporting components for stand alone operation at a later date. The BASIC shelter will consist of the following,

- **Steel framed structure with man lock**
 - Gas tight doors
 - Escape hatch
 - Exhaust valves
 - Storage shelves
 - Over pressure gauge
 - Gas Analyzer for O₂ and CO₂
- **Breathing Air Supply System**
 - Air control panel
 - Oxygen supply cylinders with dosage control
 - External air supply filter panel
- **Lighting**
 - Flashlights
 - Warning light and alarm (Dry cell battery powered)
 -
- **Room Equipment**
 - First Aid kit
 - Stretcher
 - Chemical toilet

SPECIFICATIONS**Dräger**safetyRefuge Shelter model **DSSI RS24-15**June 26
Page 4**Technical Data**

Escape chamber layout	Maximum occupancy	15 persons
	Usage period	24 hours
	ambient temperature in case of fire	max. 50 °C
Container	outer dimensions without equipment fitted on the outside	8m L x 2.4m W x 2.5m H (26.2'L x 8.0'W x 8.2'H)
	weight	approx. 4,150 kg (9,100lbs)
	max. allowed pressure load	1000 Pa (10 mbar)
Air supply for positive pressure operation	Air supply bank	High pressure compressed air cylinders supply pressure: 300 bar (4,300 psi)
	Testing unit	HP Air Cylinder (for testing purposes)
	dosage rate	120 L/min when adjusted in the green range
	positive pressure inside chamber	at least 100 Pa
Oxygen supply	O ₂ - supply	High pressure oxygen cylinders,
	supply pressure/ operating pressure	200 bar / 5.5 bar
	O ₂ dosage rate	8 L/min
	O ₂ -monitoring via Dräger gas detection instrument	Alarm levels: min. 19 Vol. % max. 22 Vol. %
CO₂ absorption	CO ₂ absorber	Forced ventilation array with twin blowers
	CO ₂ absorber cartridge-	DraegerSorb S
	CO ₂ - concentration	< 1 Vol. %
	CO ₂ - monitoring via Dräger gas detection instrument	1. alarm level 0,5 Vol. % 2. alarm level 1,0 Vol. %
Cooling	Air Conditioner	Split type room air conditioner modified
	Heat removal	100 W per person
	Condenser protection	Dust filtration
Electrical System	External control panel	External power connection, switches and breakers
	Battery control panel	Battery switching circuit, charger and inverter
	Battery Array	VRLA batteries 24V for 24hr capacity at full load for air conditioner and CO ₂ absorber

SPECIFICATIONS

Refuge Shelter model DSSI RS24-15

Drägersafety

June 26
Page 5

	Lighting/other	Room fluorescent lighting, Emergency lighting, wall outlets, External warning light, alarm
--	----------------	--

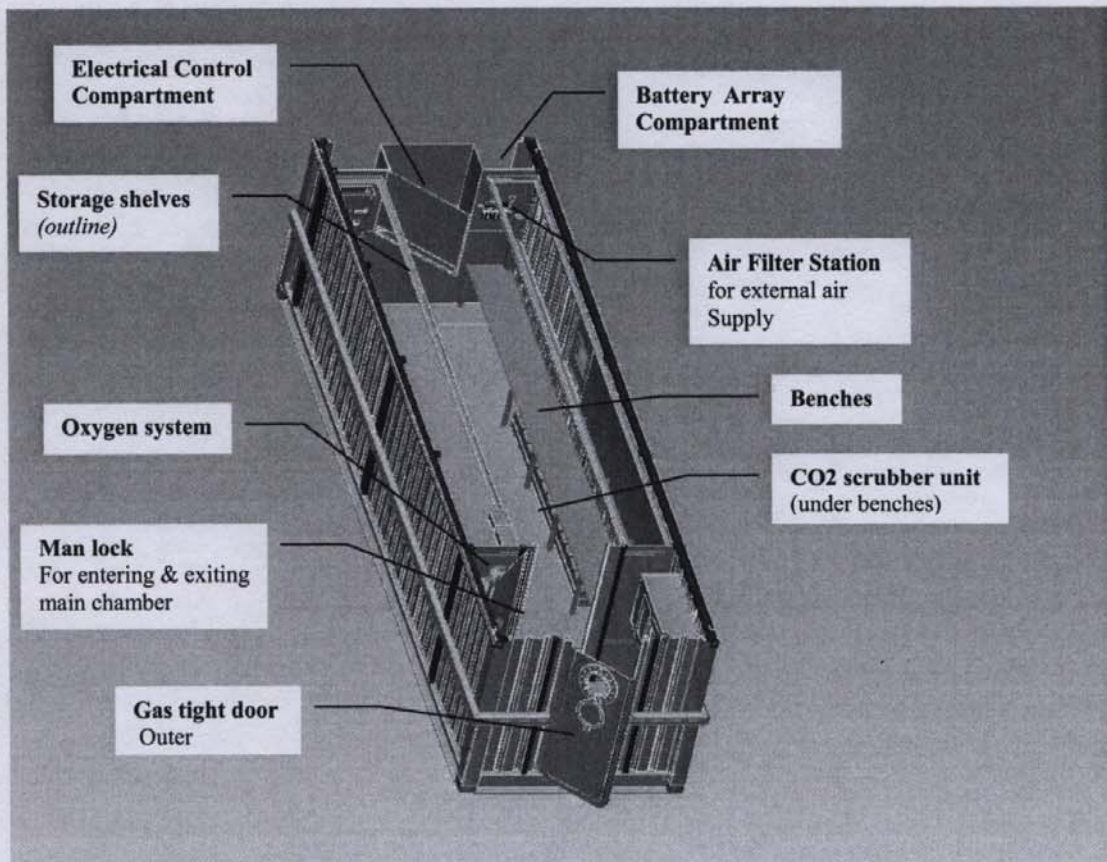

SPECIFICATIONS

Refuge Shelter model DSSI RS24-15

Drägersafety

June 26
Page 6

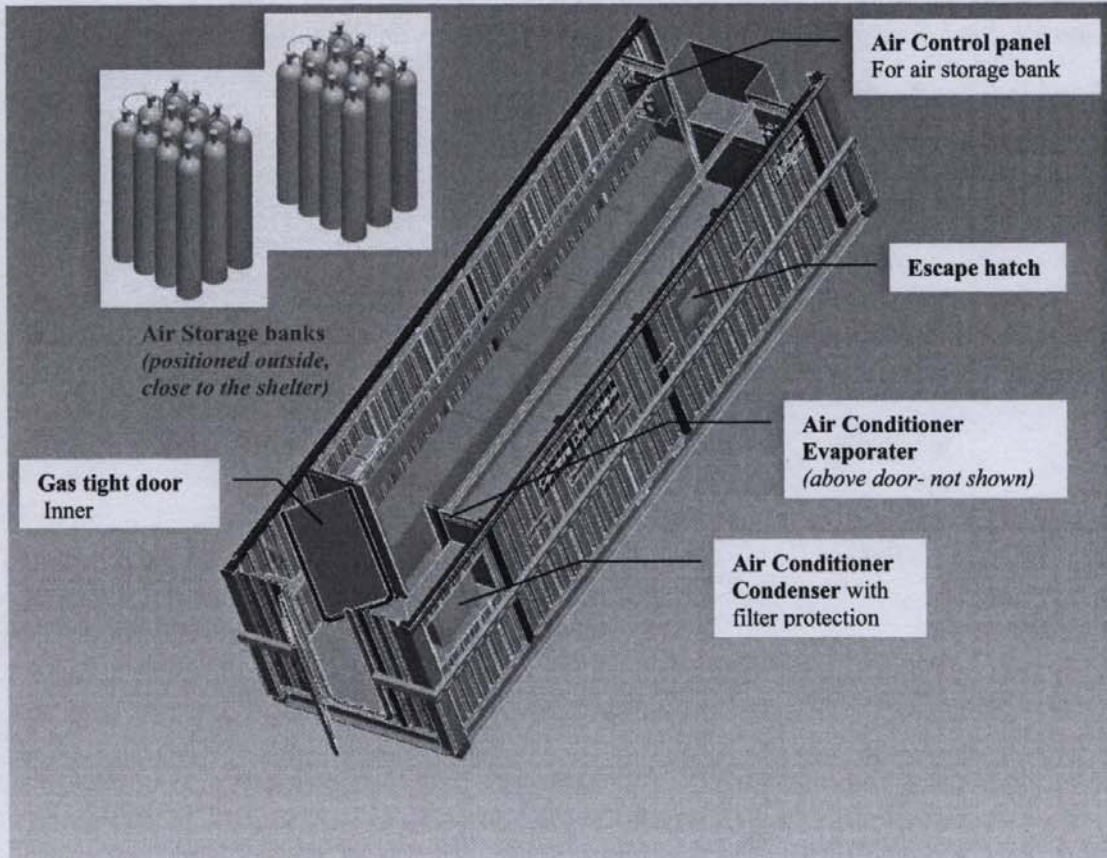

General layout of a typical shelter. The actual appearance may change due to final design parameters

Note: Shelters can be customized to any specification, provided that these customizations do not interfere with the basic life support function of the shelter.

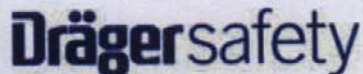

www.draeger.com



Dräger PSS BG-4

Dräger OxyK Plus S

Refuge Shelters

Contact



▪ [Zoom](#)

Refuge Shelters

The Dräger Refuge Shelter or Escape Chamber is specially designed for use in mining and tunneling operations to provide shelter for persons working underground in the event of a situation yielding a non-breathable atmosphere (IDHL atmosphere). This situation may develop for example in case of an explosion, fire, cave-in or other accident.

- [Contact us, click here!](#)

Steel framed structure with man lock

- Gas tight doors
- Escape hatch
- Exhaust valves
- Storage shelves
- Air Conditioning system
- Over pressure gauge
- Gas Analyzer for O2 and CO2

Model DSSI RS24-15

The shelter is designed to accommodate 15 people, and to provide these people with life support to last up to 24 hours independent of external electrical or air supply. Of course, if external services are available, the life support period is extended beyond this 24 hour period.

- [DSSI RS24-15 \(PDF, 624kB\)](#)

Phone: 1 - 800 615-5503

Fax: 412 787-2207

- [Contact us, click here!](#)

Model DSSI RS24-20

The shelter is designed to accommodate 20 people, and to provide these people with life support to last up to 24 hours independent of external electrical or air supply. Of course, if external services are available, the life support period is extended beyond this 24 hour period.

- [DSSI RS24-20 \(PDF, 627kB\)](#)
- [Contact us, click here!](#)

GAMMA SERVICES

Gamma Services International, Inc.

Gamma Services International, Inc. (Gamma) is developing a portable mine refuge chamber called the Rescue POD. The prototype is a portable steel refuge chamber designed to support 16 people for more than 96 hours. The unit has a low profile (3.7 feet high) and is being designed specifically for coal mines. A copy of a presentation that provides information relating to this chamber is provided in this section.

Dwayne Towery (of Gamma) was contacted and asked for information about the Rescue POD. Specifically, he was asked for information about the number of refuges sold, number and identity of any mines (coal and metal/nonmetal) where their refuges are located, instances where any refuges have been used, and requirements for maintenance of their refuge shelters.

Dwayne Towery indicated that they are still currently designing and fabricating their Rescue POD. They have not sold any units to date and are initially concentrating on the US coal market with plans to expand internationally. The design of the chamber provides for monthly inspections and minimal maintenance requirements. He indicated that he would inform us of future developments. The NTTC will forward NIOSH any information provided after the issue of this report.



Why a Rescue POD

- Loss of our fallen colleagues.
- Modern technology is being pursued by the mining community as a result of the recent loss of lives.
- Seal-In-Bratticing has often been a last ditch effort to save your life when all other options have been exhausted to exit the mine, with very few successful attempts.
- Miners are among the most independent and self-reliant people in the world.
- Naturally, miners prefer self-rescue than to rely on a rescue party to reach them from the surface. Building a trust between the miners and the equipment.

Patent Pending

Key Components



- Rescue POD is a fully deployed rugged steel enclosure to help shelter miners from secondary explosions and roof falls while providing breathable oxygen. A POD typically stays with a mining unit although additional POD's can be located out-by the working sections.
- The standard size Rescue POD is designed to support life for 16 people for 96+ hours in a compact size: (16 feet long X 5.7 feet wide X 3.7 feet high).
- Incorporate Through-The-Earth, battery powered, Geosteering TG MinerTracker , while inside and/or near the Rescue POD.

Key Components (Cont.)



- Mine atmosphere with as little as 4% oxygen can be used as an oxygen source.
- Temperature reduction support system.
- CO, C_H4, CO₂, N₂, Ar, scrubber and H₂O dehumidifier inside the Rescue POD.
- Portable self contained breathing units adds to interior oxygen supply.
- Interior and Exterior monitoring C_H4 and CO₂ levels



Key Components (Cont.)

- Nutrition and hydrating supplies for miners.
- Canister toilet with privacy curtain.
- Chem.-stick Lighting
- Introducing a Nitrogen foaming fire fighting technique while miners are down stream of the fire, regardless of the limited gas levels.

Patent Pending

Oxygen Transfer

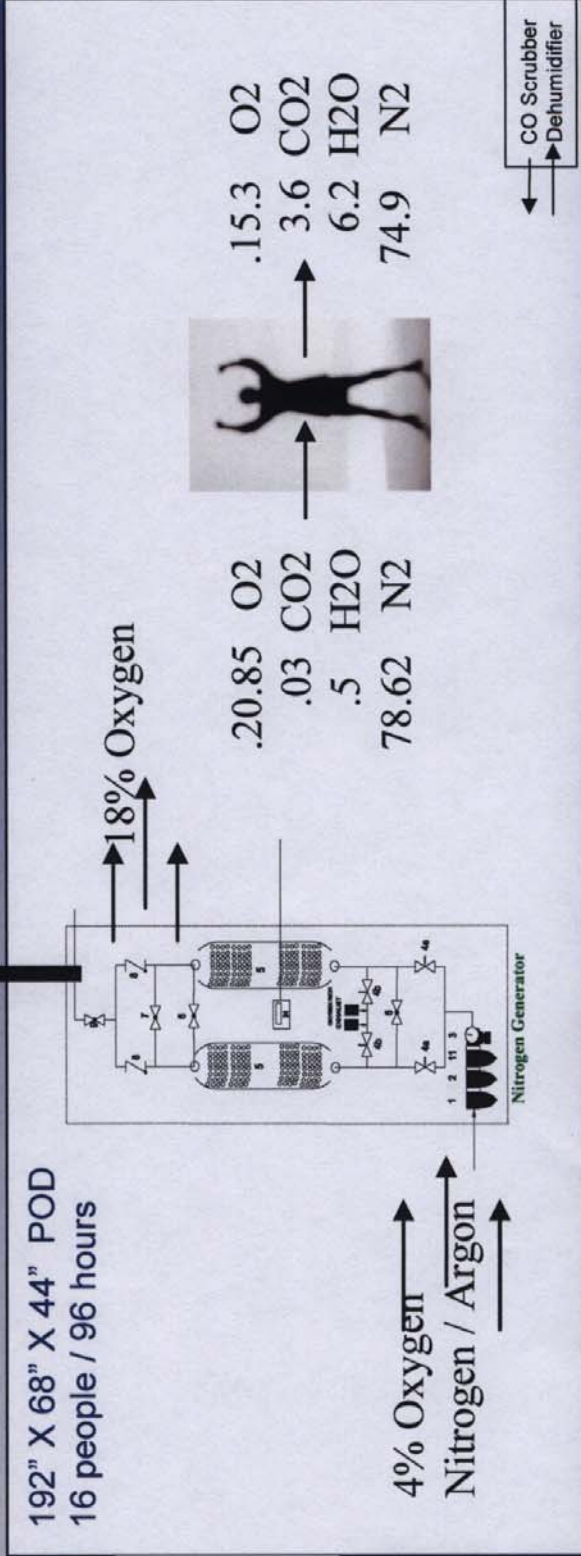

1000PPM CO
4% Methane
4% Oxygen
Nitrogen / Argon

Patent Pending

Oxygen Transfer

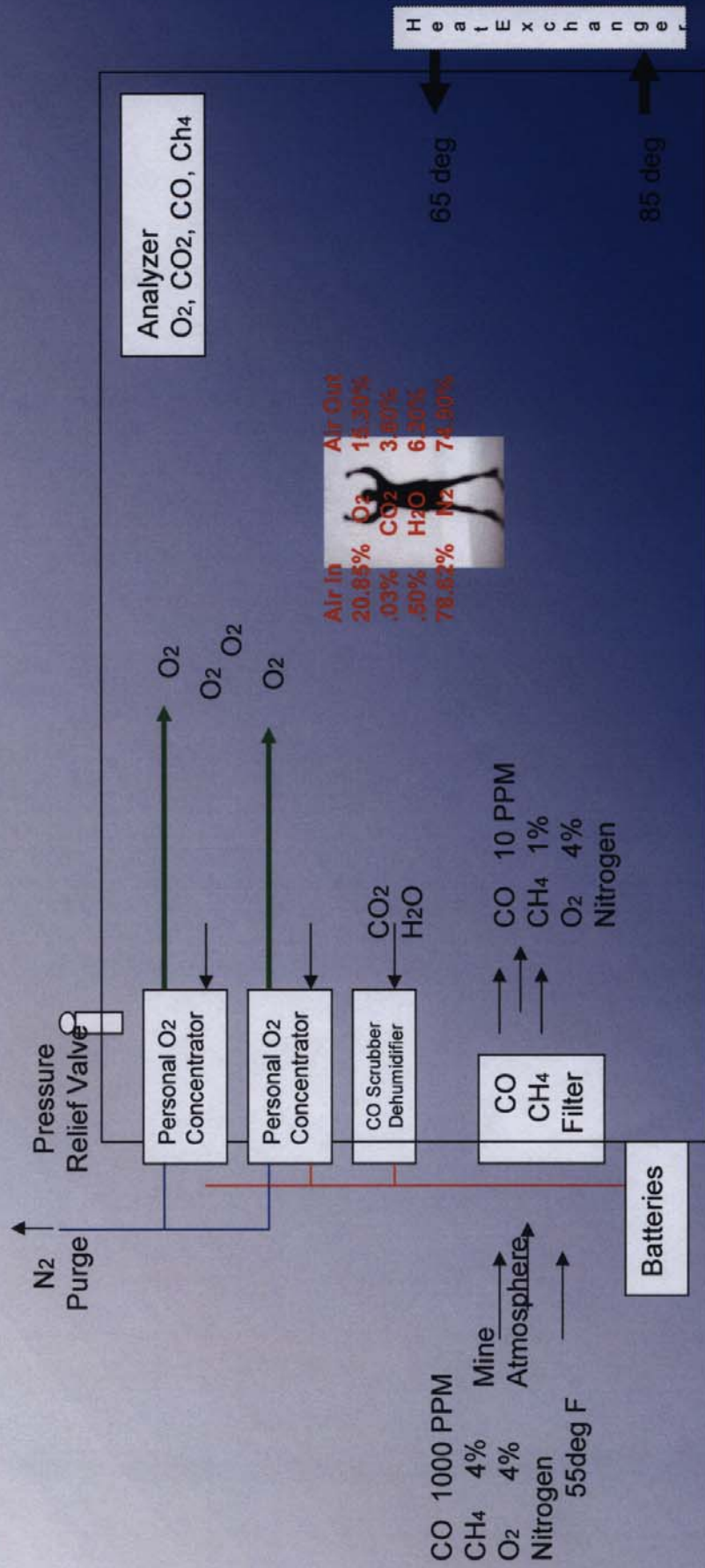

Patent Pending

Rescue POD construction



Patent Pending

Rescue POD construction



Patent Pending



Conclusion

- Utilization of rescue PODs for each mining unit could be a useful method of saving lives during mining disasters.
- Gamma Services along with all the supporting companies believes our approach is one of the answer's to saving lives right now.
- However if new ideas or guidance arises in the future, we will change our direction to expedite the deployment for life saving devices to the mining community.

Patent Pending



Thank You

Patent Pending

Welcome !



Rescue POD Safety System

Gamma Services is a Safety and Production
Assistance Company.

Patent Pending

Jack Kennedy Metal Products & Buildings, Inc.

Information about the mine refuges manufactured by Jack Kennedy Metal Products & Buildings, Inc. (Kennedy Products) was obtained from various internet sources (including their web page) and by contacting them directly. Information obtained from internet and marketing sources is attached and a summary of the information obtained from Bill Kennedy (Contact for Kennedy Products) is provided below.

According to Mr. Kennedy, the refuge chambers are designed specifically for coal mining operations and they meet the standards recommended in the West Virginia Taskforce. They manufacture three different types of shelters – 1) house – a fully constructed ready for deployment unit; 2) folding house - a folding unit that allows transport underneath low roof conditions and has no air lock; and 3) skid – a unit designed for very low roof conditions and includes supplies for barricading. No air temperature control systems are used for their chambers and Mr. Kennedy indicated that under normal US mine temperatures, their units will not exceed the West Virginia Taskforce temperature recommendations. If there is a demand for higher temperature use, they design in a cooling system. Their units can withstand a 15 psi pressure pulse and are designed to provide 100 hours of use at full capacity.

Mr. Kennedy was asked for information related to number of refuges sold, number and identity of any mines (coal and metal/nonmetal) where their refuges are located, instances where any refuges have been used, and requirements for maintenance of their refuge shelters. He indicated that their sales, customers, locations, and records of any emergency events are considered confidential. However, he did provide the following information on maintenance in an email:

“The units should be inspected at each shift (i.e. 'preshifted') by looking for obvious defects caused by physical damage and to see that the pressure gauges are up. If units are not damaged, the pressure stays up, and the seals are not broken, the units can be in service for five years. At that point we prefer that they be recommissioned at the factory as most of the materials inside will have expired, and the pressure vessels will have to be hydrostatically tested. It is possible for the customer to do this in the field, however, if they desire. At any time physical damage to the basic envelope occurs, the seal is broken, etc. other maintenance or repair may have to be performed. “

KENNEDY METAL

**Jack Kennedy Metal Products & Buildings, Inc.**

P.O. Box 138
Taylorville, IL 62568
217-287-7231
217-287-7232 (fax)

| [Home](#) | [Contact Factory](#) |

**Welcome To:
Kennedy Metal Products and Buildings, Inc.**

Jack Kennedy Metal Products and Buildings, Inc. is a closely held company formed over 50 years ago to manufacture commercial products. Kennedy Metal Products is a world class manufacturing firm with manufacturing interests on four continents. The latest computer aided design (CAD) and computer aided manufacturing (CAM) equipment is extensively used by Kennedy Metal Products.

Kennedy Metal Products is a leader in engineering and design of mechanical, structural, electronic and soft and firmware products, with many unique specialized products designed specifically for the solution of a specific problem. Kennedy Metal Products routinely provides state of the art logistical, consulting, design and other service to a wide sector of customers and clients.



Jack Kennedy Metal Products & Buildings, Inc. 217-287-7231

Introducing the **Kennedy** **CHAMBER**

**Premier Underground
Emergency Structure Designed For
Sustained Life Support**

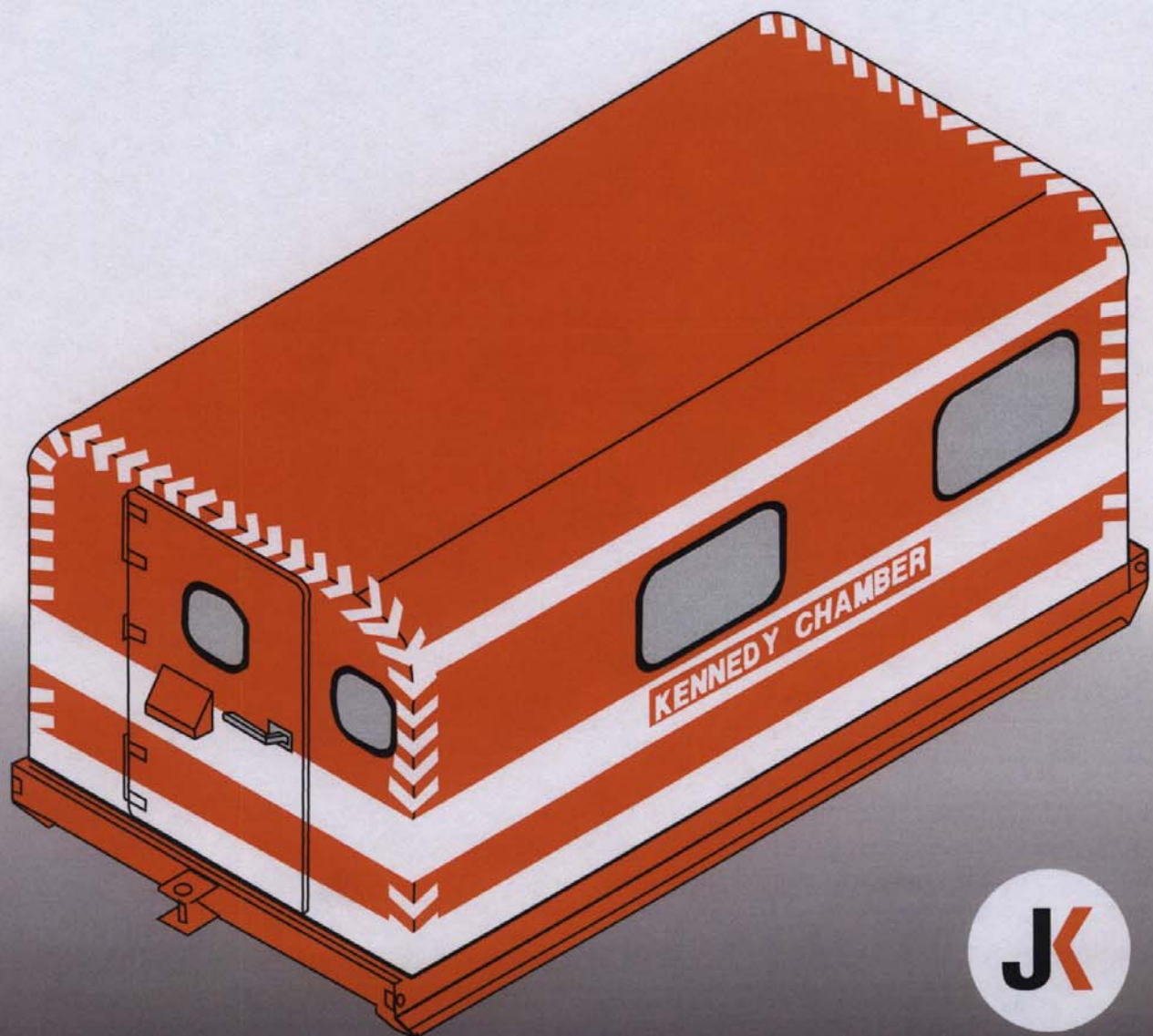

Kennedy CHAMBER

Problem

Lives often hang in the balance when an emergency traps miners hundreds of feet underground with a diminishing air supply and the clock ticking...

Solution

The Kennedy CHAMBER is a secure emergency safety structure designed for extended underground service to provide temporary space and life support for up to 23 people with oxygen and CO2 control for 100 hours at full capacity. Simply put, the Kennedy CHAMBER can save lives.

CHAMBER Features

- Oxygen and CO2 scrubbing capable of 100 hours @ full occupancy
- Very simple operation
- Top seal oxygen valves able to be left on so gauge will read
- Cylinder valve protector so cylinders can be connected at all times
- Full operating instructions placarded inside the unit
- Tight enclosure operating under positive pressure
- Bright orange paint outside with white reflectorized stickers
- Purge air provided in both house and folding house units
- Air lock entrance
- MSHA approved 300 hour flashlights
- First Aid kit
- Permissible mine phone inside unit with 'thru hull' connector
- Emergency exit windows on all sides
- Heavy 'mine duty' skid under frame
- Ability to be 'sealed' to identify if anyone has been in the chamber
- Oxygen supply is able to be checked from the outside
- Provisions -
 - Water
 - Long shelf life military food rations (MRE)
 - Psychological stress relief items
 - Books, Checkers, Playing cards, Paper, Pencils
- Chemical toilet
- Available in both fully assembled and portable/collapsible units plus material skid units
- 5 year 'shelf life' for most items
- Factory rebuild at life expiration available

Fully Collapsed
Portable Unit

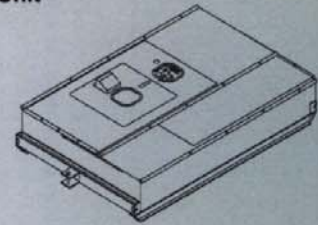

1st Panel Raised
& Locked in
Place

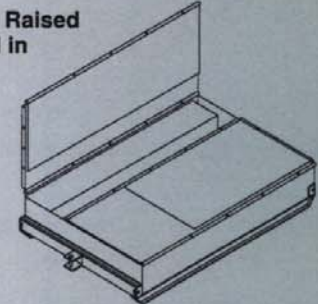

2nd Panel Raised
& Locked in
Place

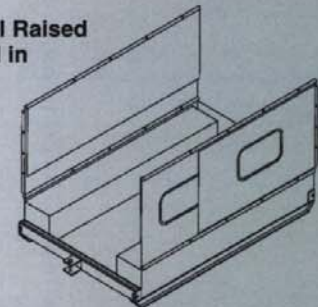

Back Panel Hinged
Around & Locked
In Place

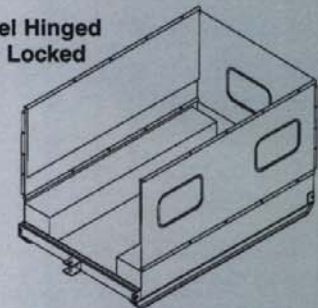

Top Panels
Raised & Locked
In Place

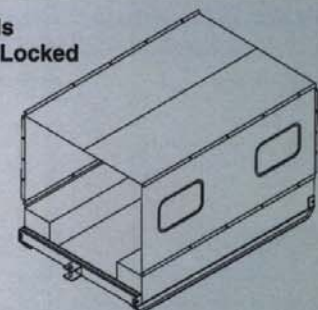

Front Panel
Hinged Around
& Locked
In Place

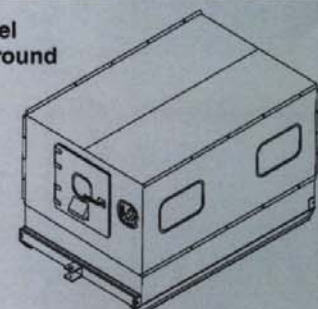

Portable Assembled Unit

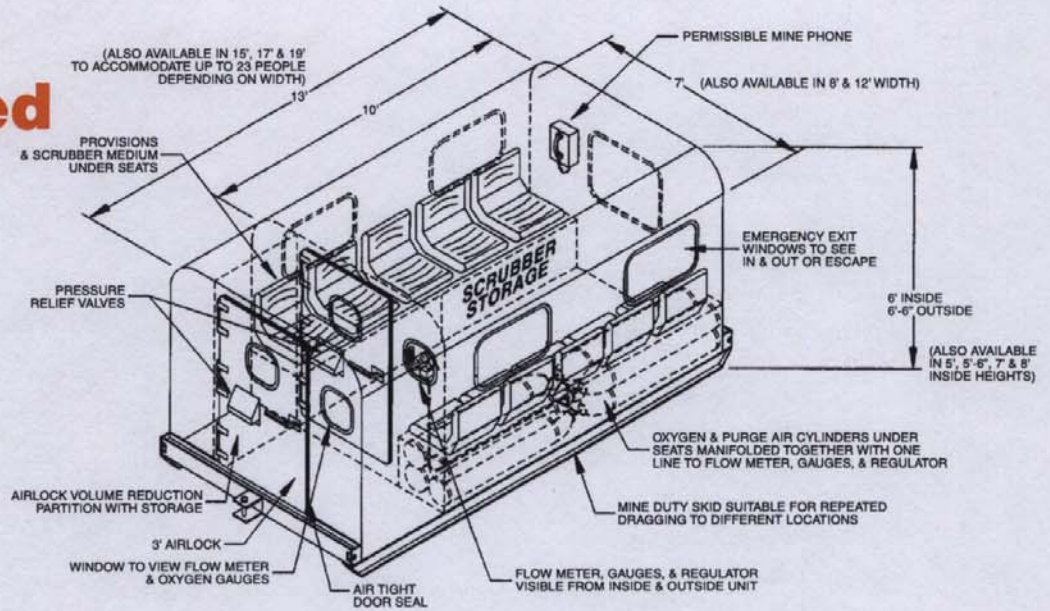

Portable & Collapsible Unit

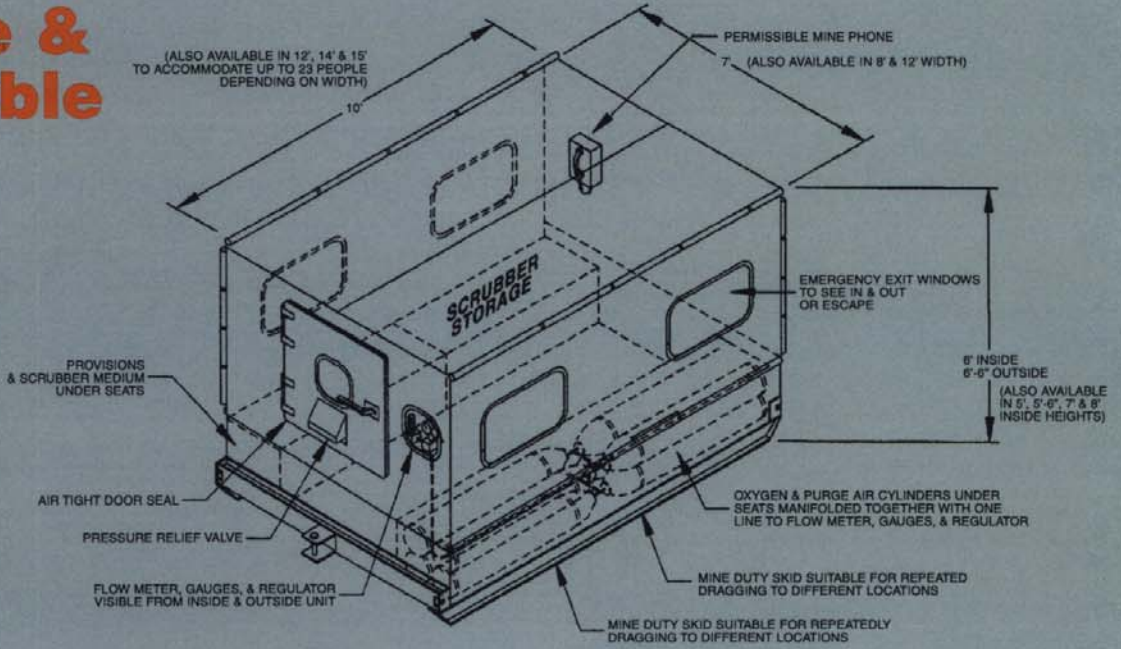

Portable Material Skid

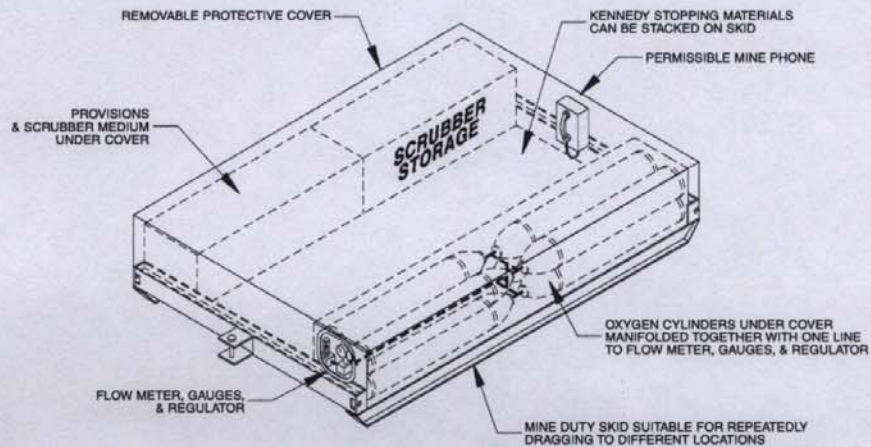

Kennedy CHAMBER Specifications and Capacity Options

Portable Assembled CHAMBER Unit

Assembled Chambers are available in various heights with widths of 7, 8, and 12 feet and nominal lengths of 13, 15, 17, and 19 feet. The seating capacity for 7 and 8 foot wide units can be determined by subtracting three from the length, i.e. a 13 foot long unit would seat 10 people. The capacity for 12 foot wide units can be determined by subtracting three from the length, multiplying by 1.5, and subtracting 1, i.e. a 13 foot unit would seat 14 people. Life support duration is 100 hours (four days) at full occupancy.

Portable & Collapsible CHAMBER Unit

Collapsible units are available in various heights with widths of 7, 8, and 12 feet and nominal lengths of 10, 12, 14, and 16 feet. The seating capacity for the 7 and 8 foot wide units can be determined from the length, one person per foot of length, i.e. a 10 foot long unit would seat 10 people. The capacity of 12 foot wide units can be determined by multiplying the length by 1.5 and subtracting 1, i.e. a 10 foot unit would seat 14. Life support duration is 100 hours (four days) at full capacity.

Portable CHAMBER Material Skid Unit

Skid only units are available in widths of 7, 8, and 12 feet and nominal lengths of 10, 12, 14, and 16 feet. The life support capacity is calculated the same as a collapsible unit. Life support duration is 100 hours (four days) in a tightly sealed enclosure without other gas input from the strata, etc.

About Kennedy

Kennedy Metal Products has been working to make mining safer and more productive for decades. We are recognized experts in mining ventilation and safety with plants and warehouses on four continents.

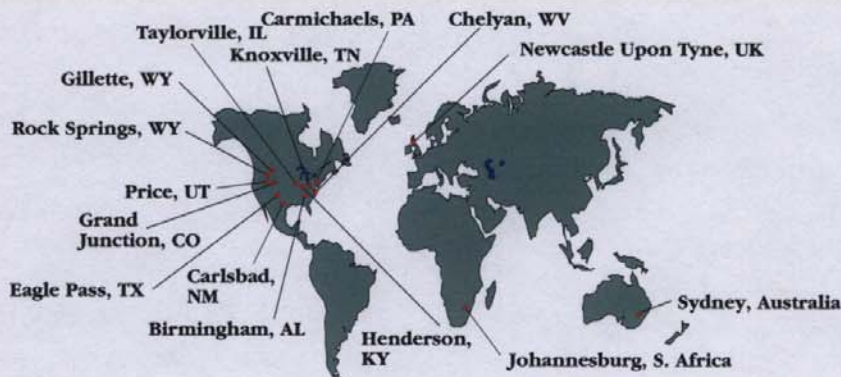

**Kennedy
CHAMBER**

**The Premier
Underground
Emergency
Structure
for Sustained
Life Support**

Jack Kennedy Metal Products & Buildings, Inc.

P.O. Box 138
Taylorville, Illinois 62568
Phone 217.287.7231
Fax 217.287.7232
E-mail info@kennedymetal.com

PATENT INFORMATION

These products are covered by one or more United States or Foreign Patents, granted or pending.

Copyright © 2006 by Jack Kennedy Metal Products & Buildings, Inc. All rights reserved. Printed in U.S.A.
Prices and specifications subject to change without notice.

The Kennedy Chamber

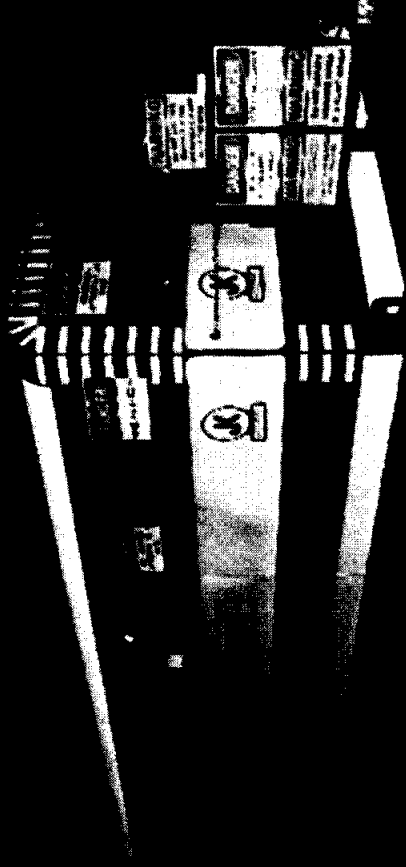

A Life Support System For Underground Mines

This presentation shows products that have patents granted or pending, US or foreign.

Entire Presentation Copyright 2006
Jack Kennedy Metal Products &
Buildings, Inc.
All Rights Reserved

The Kennedy Chamber

Escape The Mine!



Chambers Are Simply Better Barricade Materials

The Kennedy Chamber

**But If You Can't
Escape You Might
Want a Chamber**

Design Criteria

100 Hour Operation At Full Capacity
Very Quick Initialization
Purge Air To Quickly Ready Chamber
(House Units)
Onboard Oxygen Supply Without
Chemicals, Heat Or Ignition Sources

Design Criteria (Con't)

Oxygen Rate Adjustable
According To Occupancy
CO2 Scrubbing
Positive Pressure Operation
No Power Required
'Mine Tough' Unit
5 Year Commission Life

Mine Tough

The Chamber Is Designed To Be Used In An Underground Mine

The Skid Design Allows Repeated Movement With A Minimum Of Unit Height

A Special 'Hardened' Version Is Available As An Option

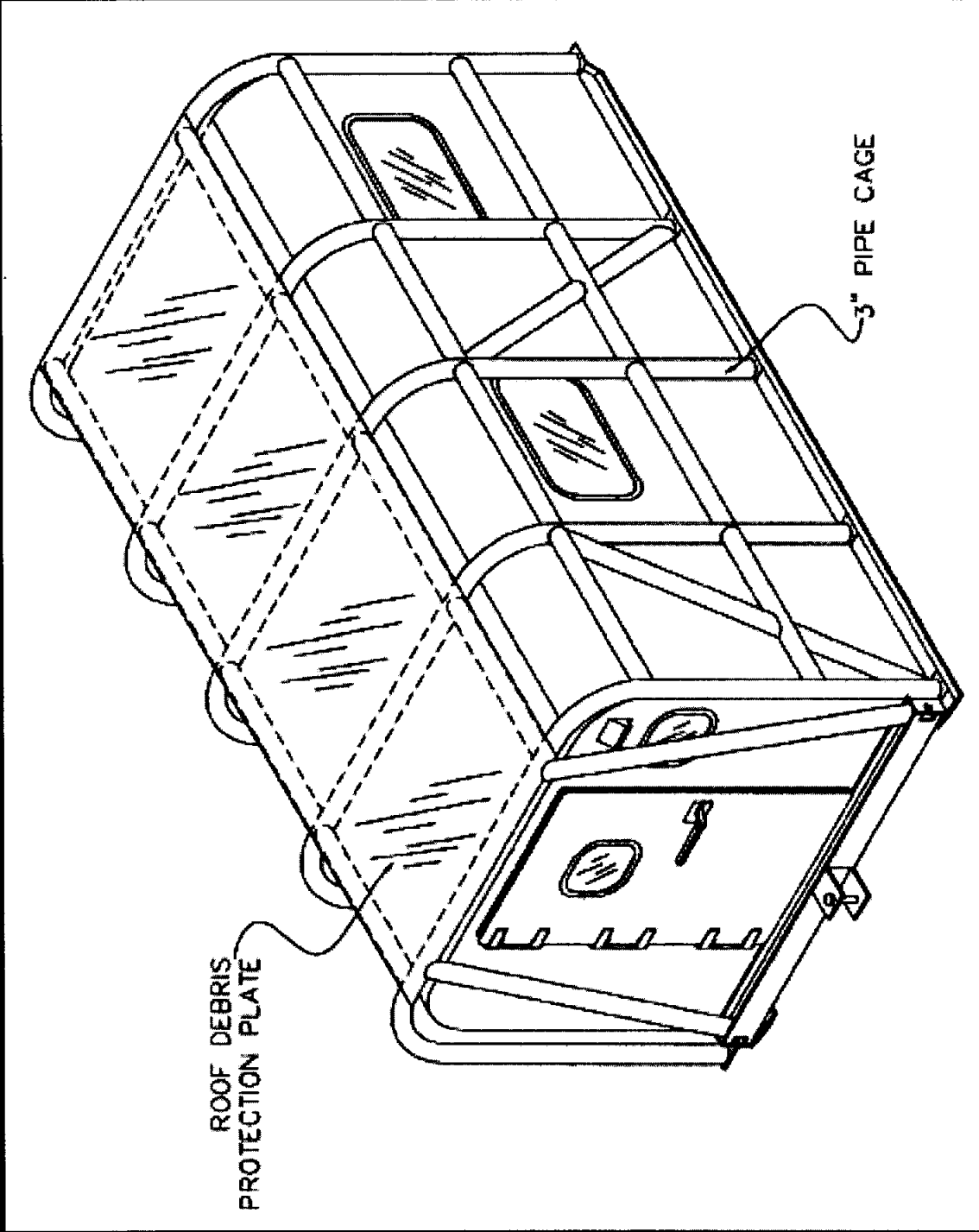

The Kennedy Chamber

Life Support Capacity

100 Hours At Full Capacity
200 Hours At Half Capacity

Capable Of Two Times Overload
At Half Duration

'Instant' Setup Time

Most Of The Time All You Have To Do To Use The Chamber Is Enter It If It Is Contaminated, Purge Air Is Supplied To Blow Out The Chamber Oxygen Flow Is Started With The Turn Of A Knob CO2 Scrubbing Is Initialized In Minutes

Simple Operation

No. 1 Purge Chamber (If Necessary)

No. 2 Start Oxygen Flow

No. 3 Deploy Scrubber Material

Deployment Instruction Placard



No. 1 Open The Purge Air Valve

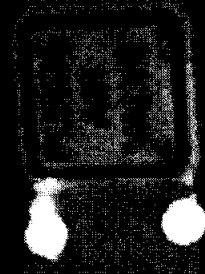

The Kennedy Chamber

Purge Air Muffler

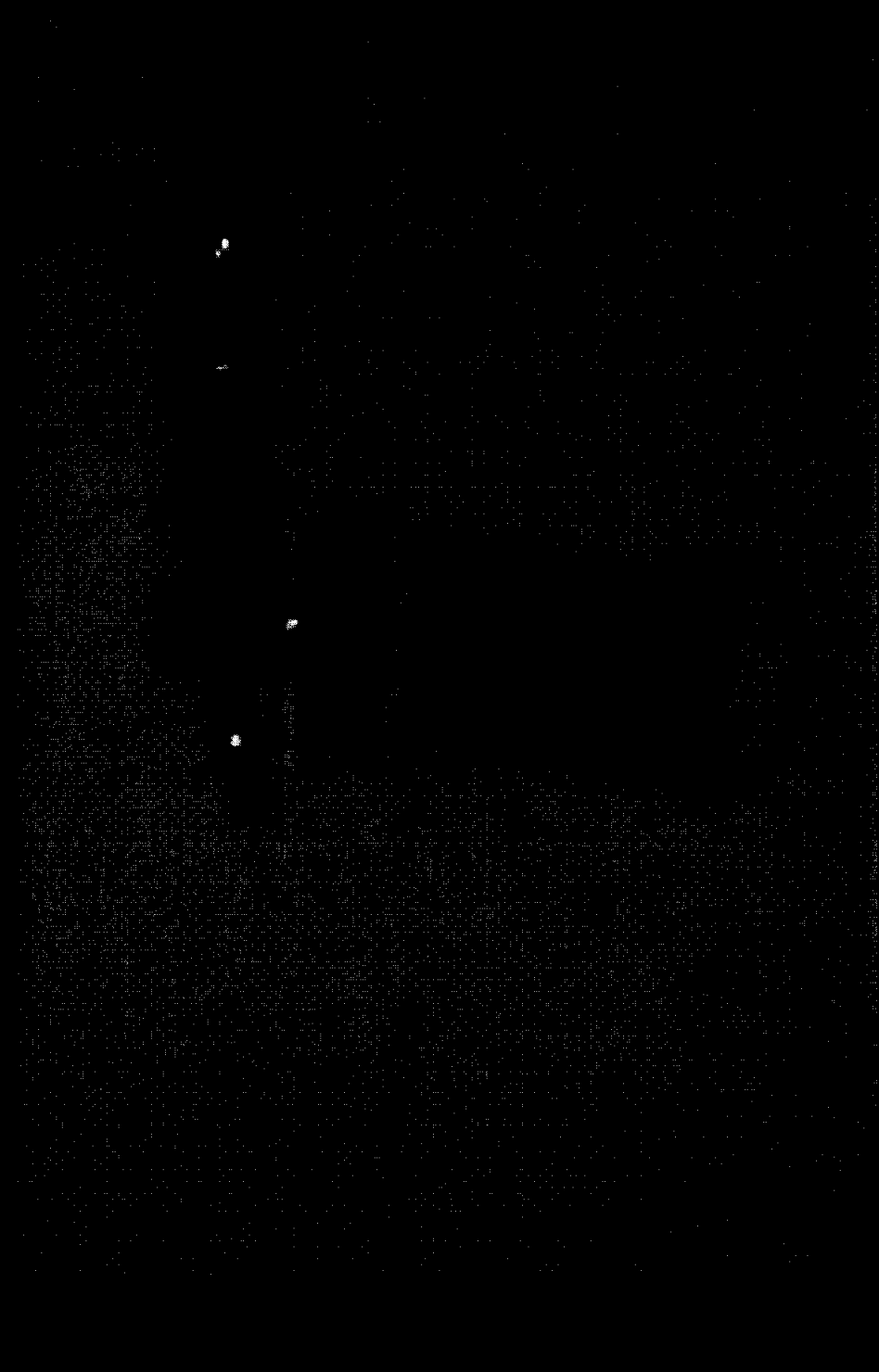

No. 2 Start Oxygen Flow

Oxygen Must Be Regulated
According To The Number Of
People In The Chamber
Too Little Causes Hypoxia
Excess Flow --

- ◆ Wastes Chamber Time
- ◆ Causes Oxygen Toxicity
- ◆ Creates A Fire Hazard

Oxygen Placard

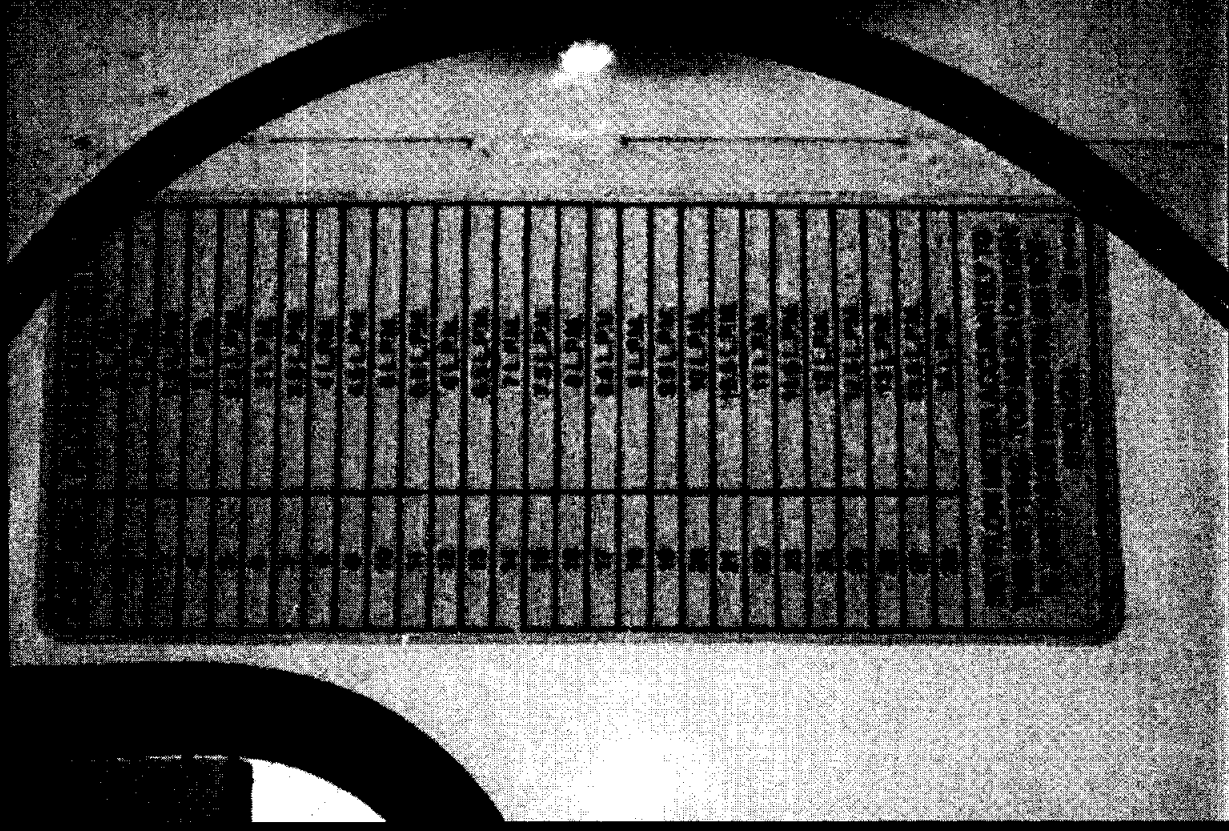

The Kennedy Chamber

Oxygen Flow Meter



The Kennedy Chamber

No. 3 Start CO2 Scrubbing

CO2 Control Is By Lithium Sheet
No Power Is Required
Very Long Periods (Hours)
Between Sheet Changes

Scrubbing Media Timer

Mechanical 24 Hour Timer With Bell

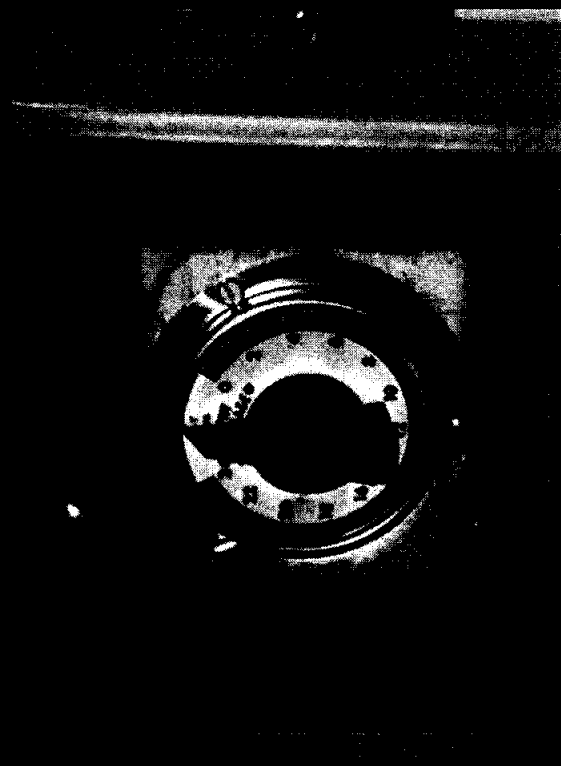
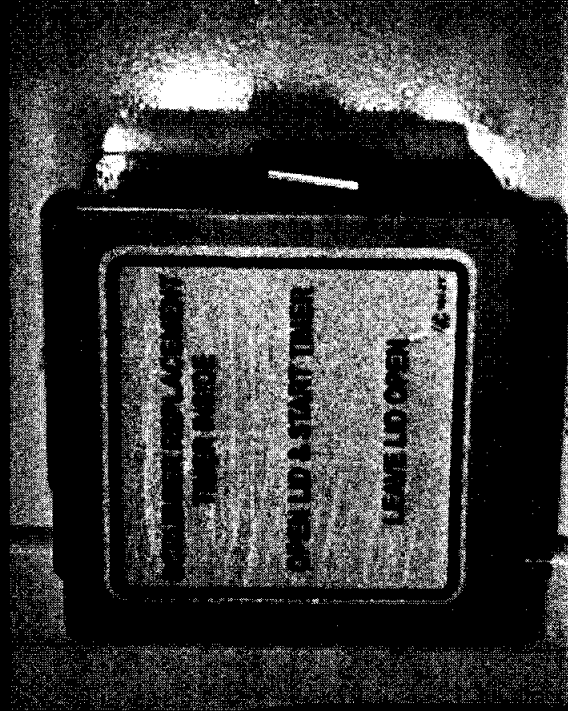

The Kennedy Chamber

5 Year Commission Life

Everything In The Chamber Is
Designed For A 5 Year Life
WITHOUT Maintenance

Routine Inspection Only Requires –

- ◆ Looking At The Outside For Damage
- ◆ Checking The Air and Oxygen Gauges
- ◆ Checking The Tamper Seal

Pressure Gauges



Gauges Visible Without Entering Chamber
Oxygen Gauge Visible From Both Directions

Recommissioning

Factory Recommissioning Is
Available

At Their 5 Year Anniversary The
Oxygen And Air Cylinders Must Be
Removed And Hydrostatically
Tested

Provisions Replaced

Damage Repaired

Three Unit Types --

House

Folding House

Skid

House

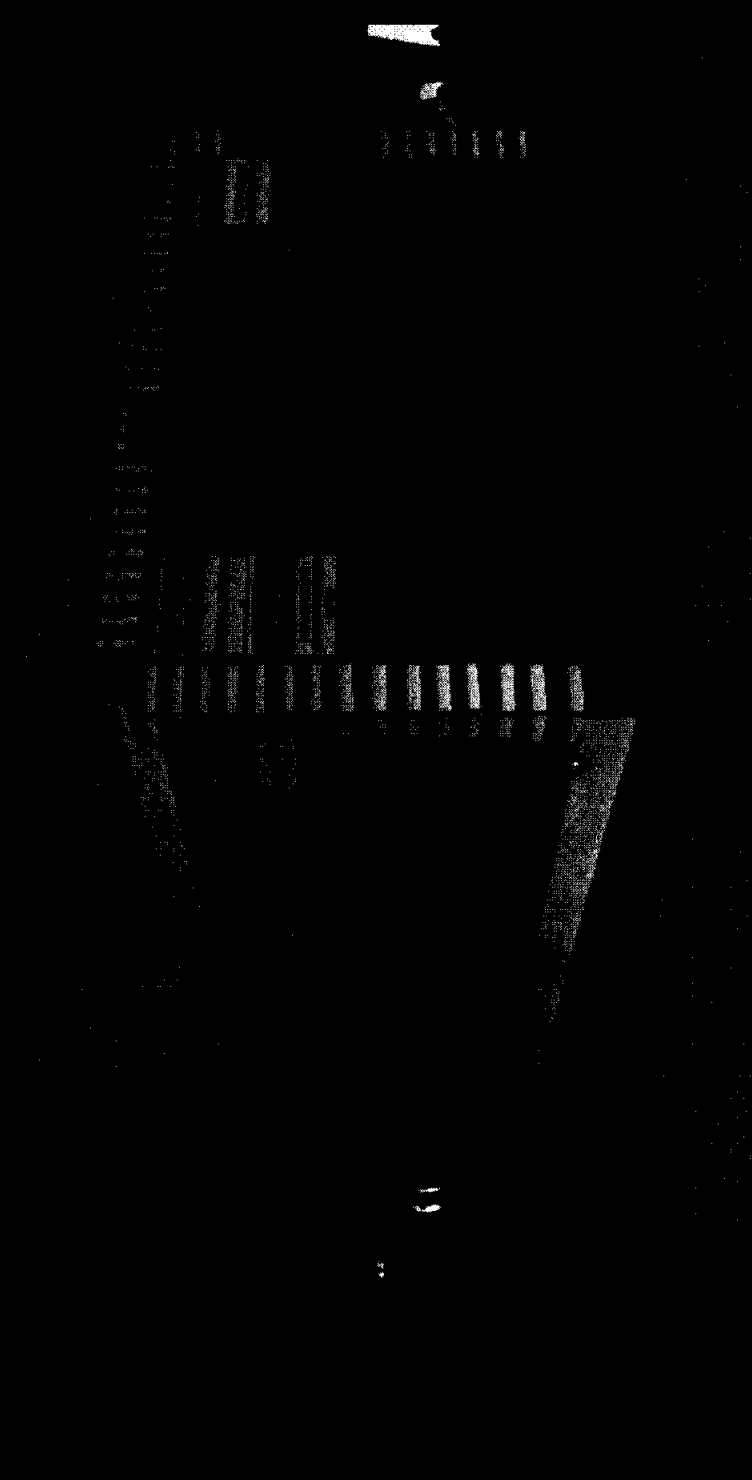

Best Choice – Ready To Go – Very Cost
Effective

The Kennedy Chamber

Folding House Unit

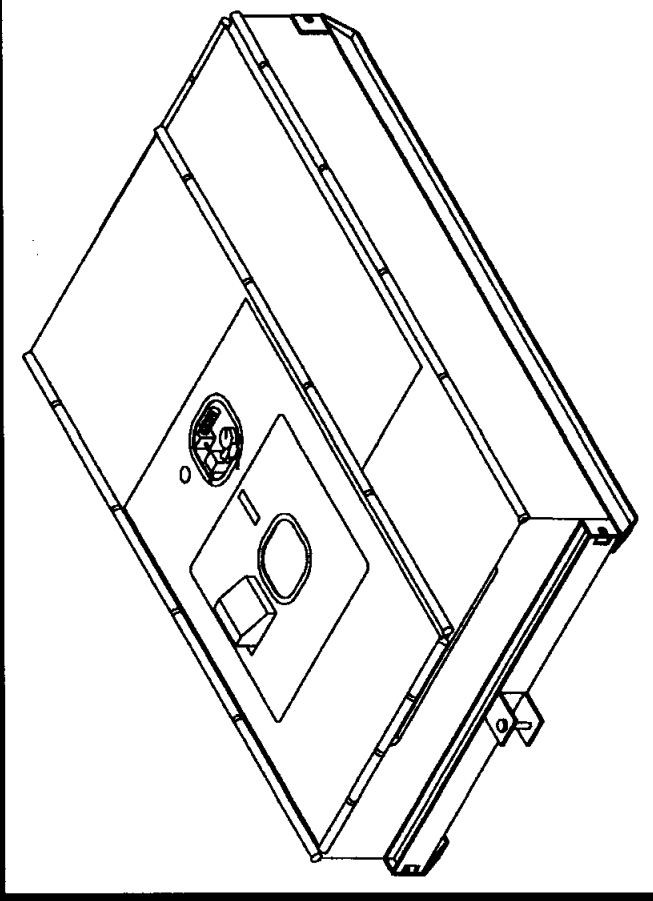

Allows Transportation Under Low Top
Deployment Takes No More Height Than A Completely
Deployed Unit
Contains Everything A House Unit The Same Capacity Has
Does Not Have An Airlock

Step 1

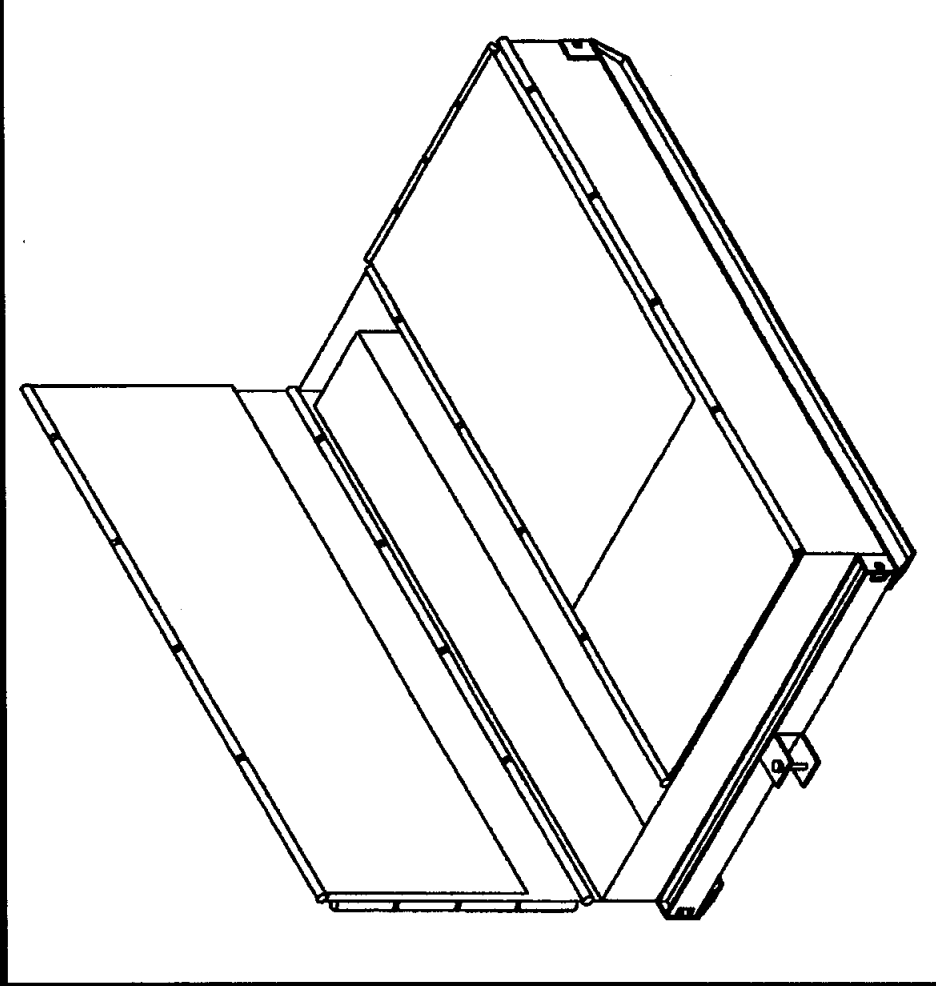

The Kennedy Chamber

Step 2

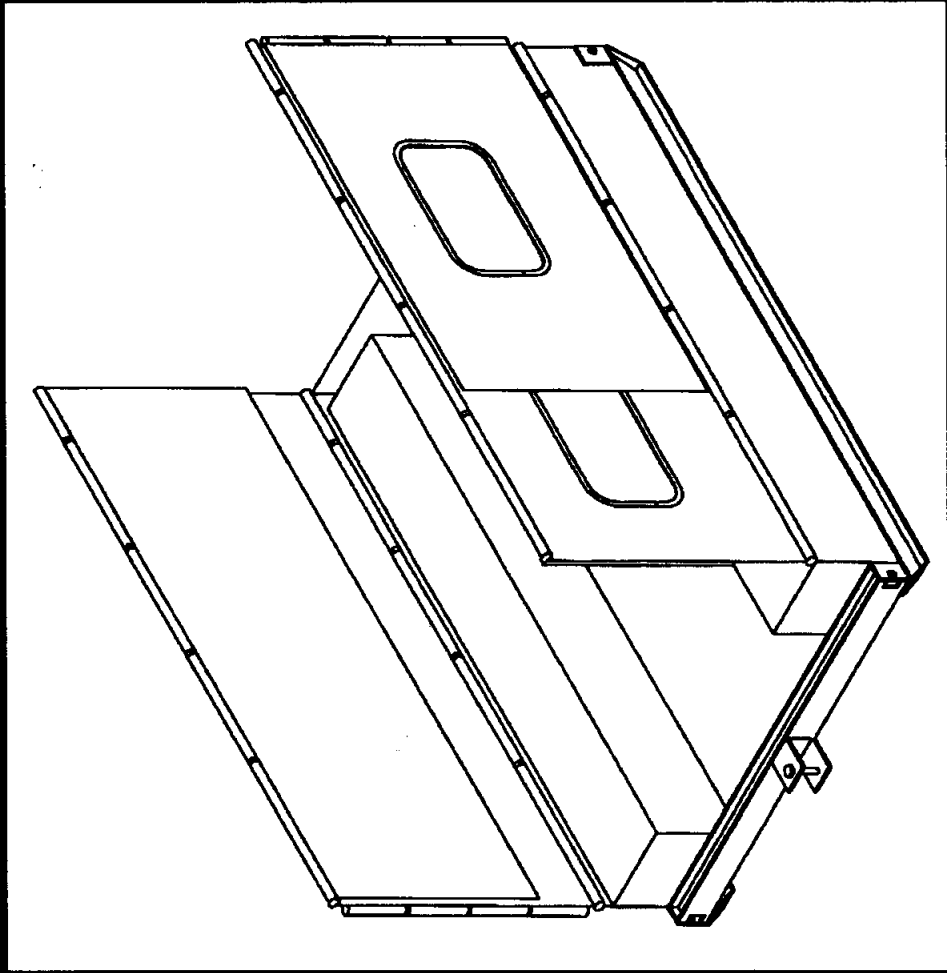

The Kennedy Chamber

Step 3

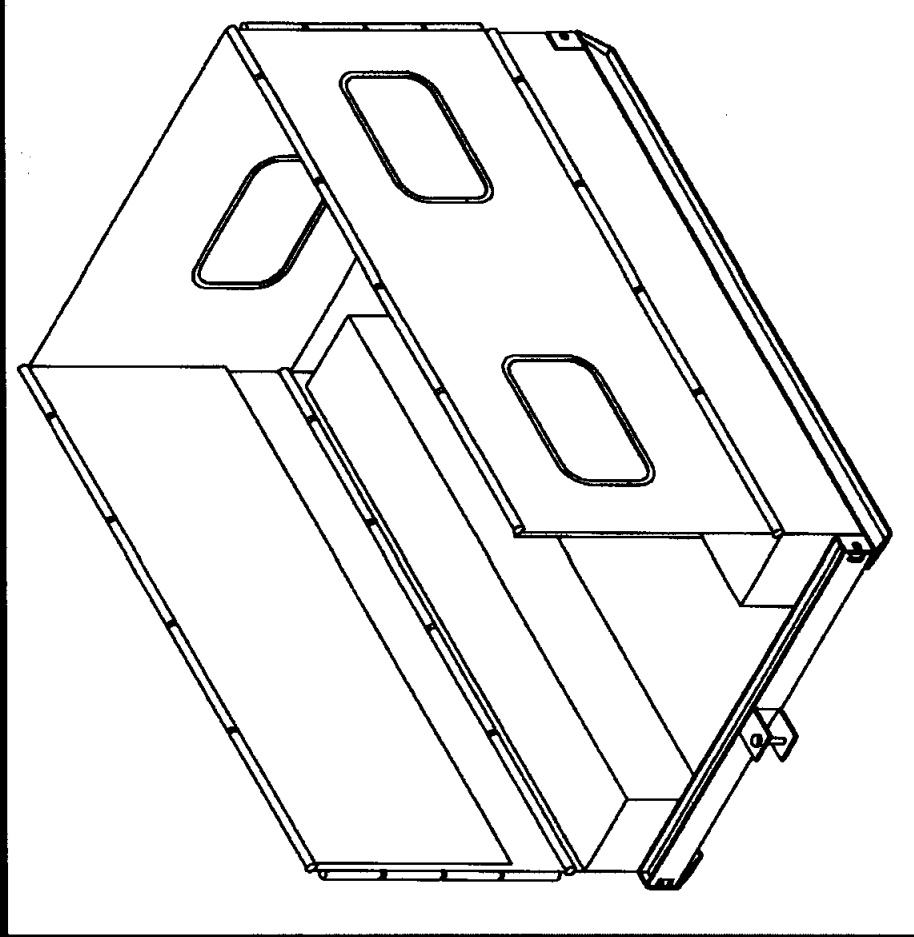

Step 4

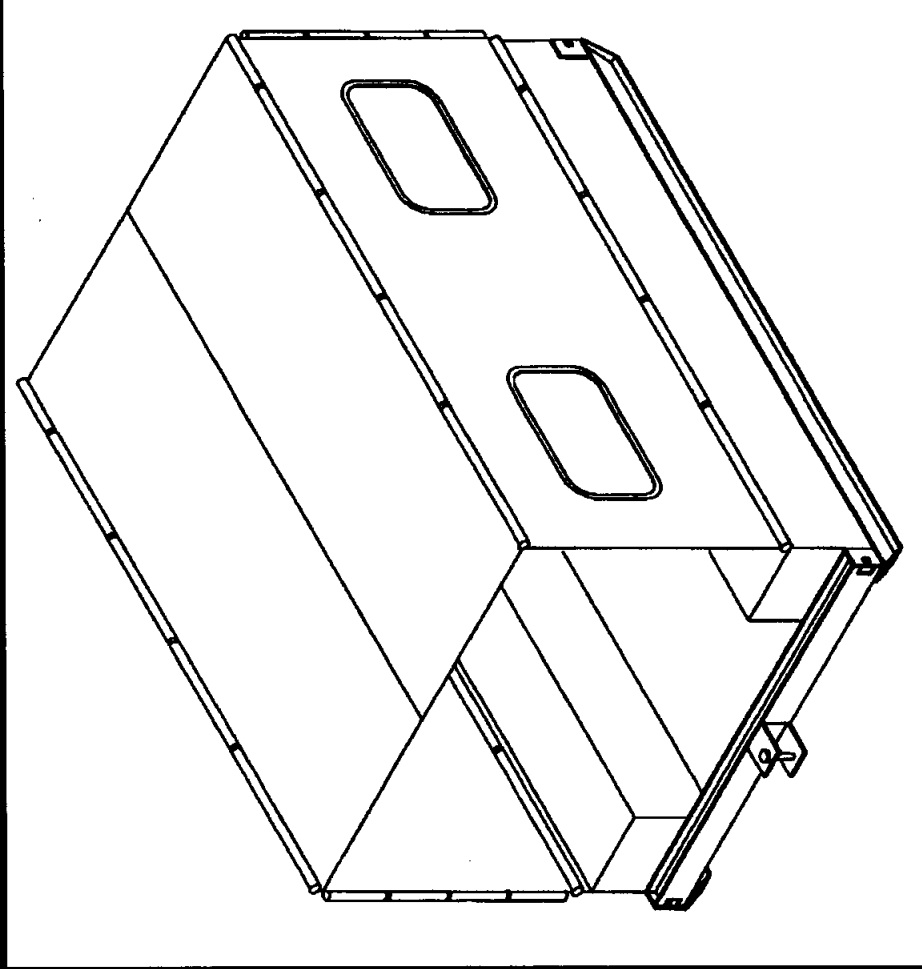

The Kennedy Chamber

House Unit Deployed

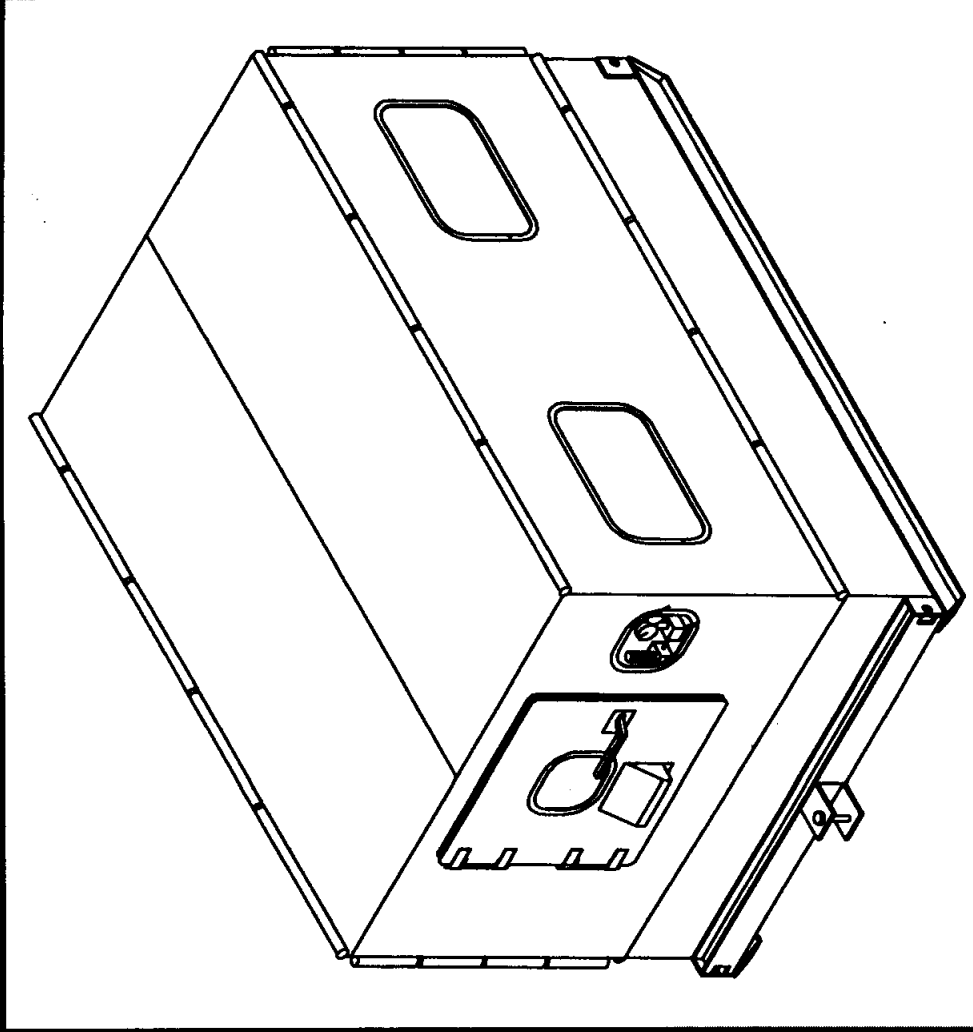

The Kennedy Chamber

Skid Unit

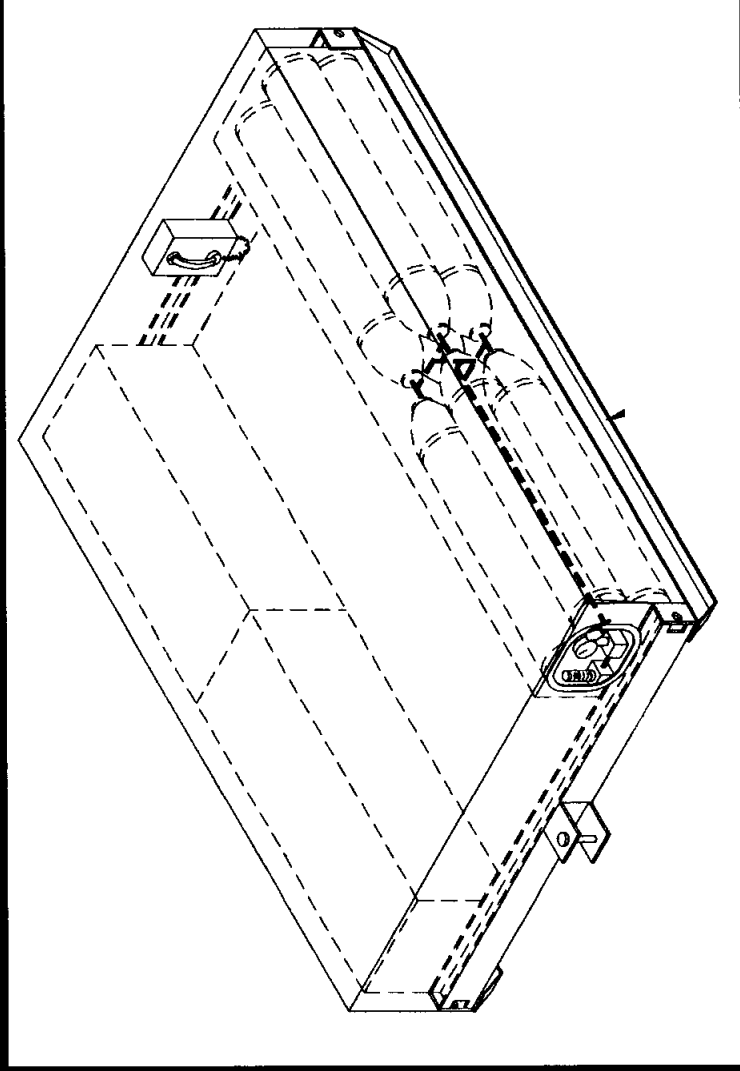

Suitable For Very Low Conditions
Can Carry Barricade Materials
Contains Everything A House Unit The Same Capacity Has

Design Details

The Kennedy Chamber

31

Heavy Cylinder Containment

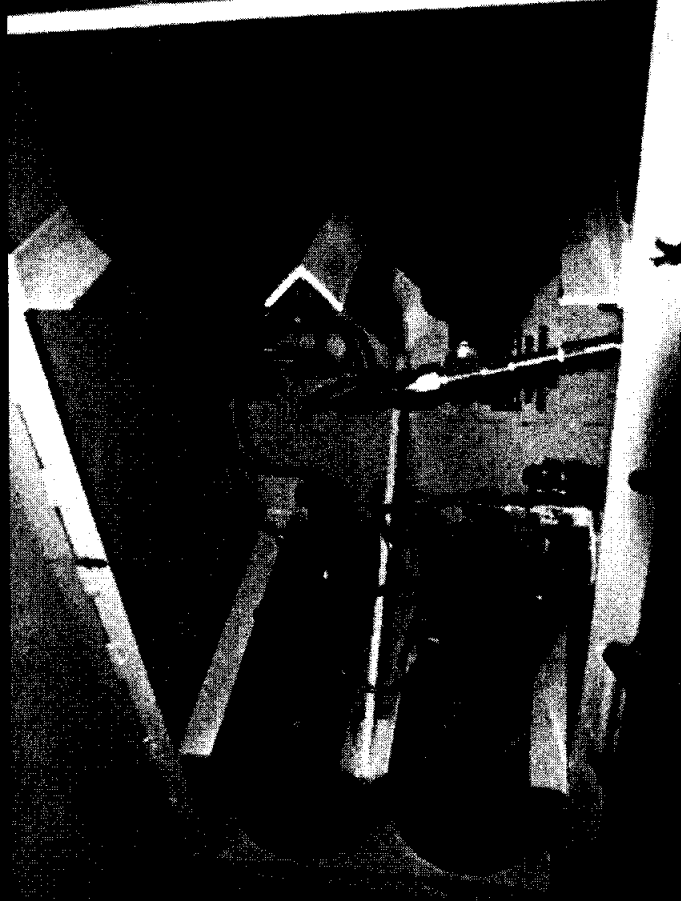

1/2" Plate 'Armor'
Special Longitudinal Restraint

Energy Absorbing Design

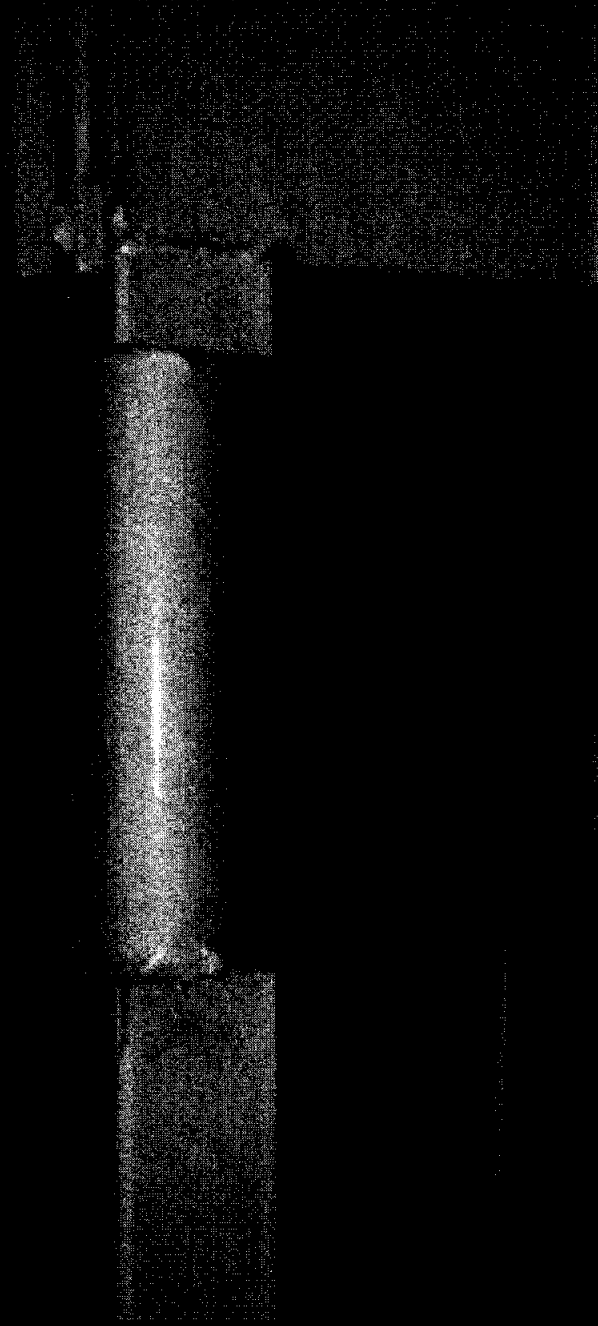

The Kennedy Chamber

Escape Windows

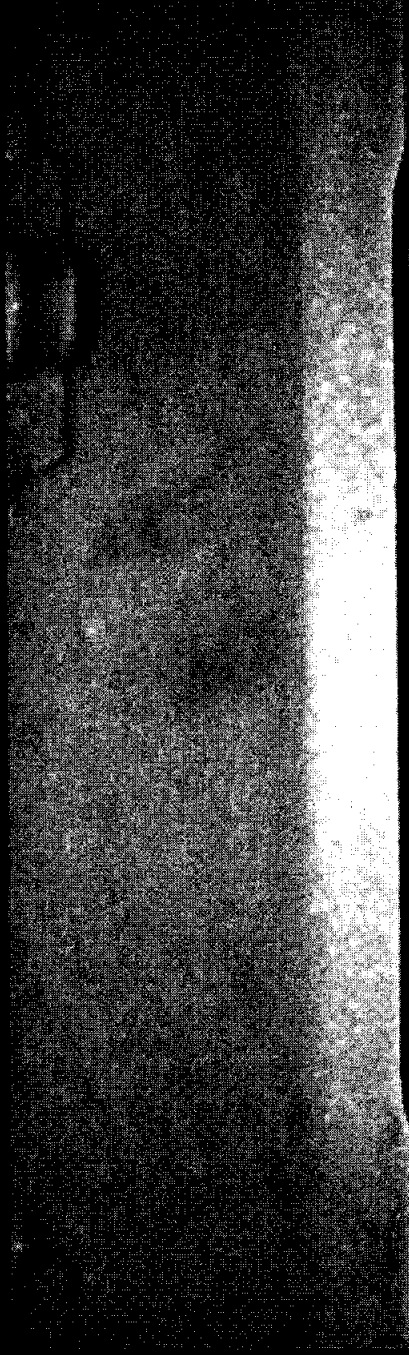

EMERGENCY EXIT
PULL HANDLE - REMOVE STRIP - PUSH GLASS

Permissible Telephone

'Thru Hull' Connectors

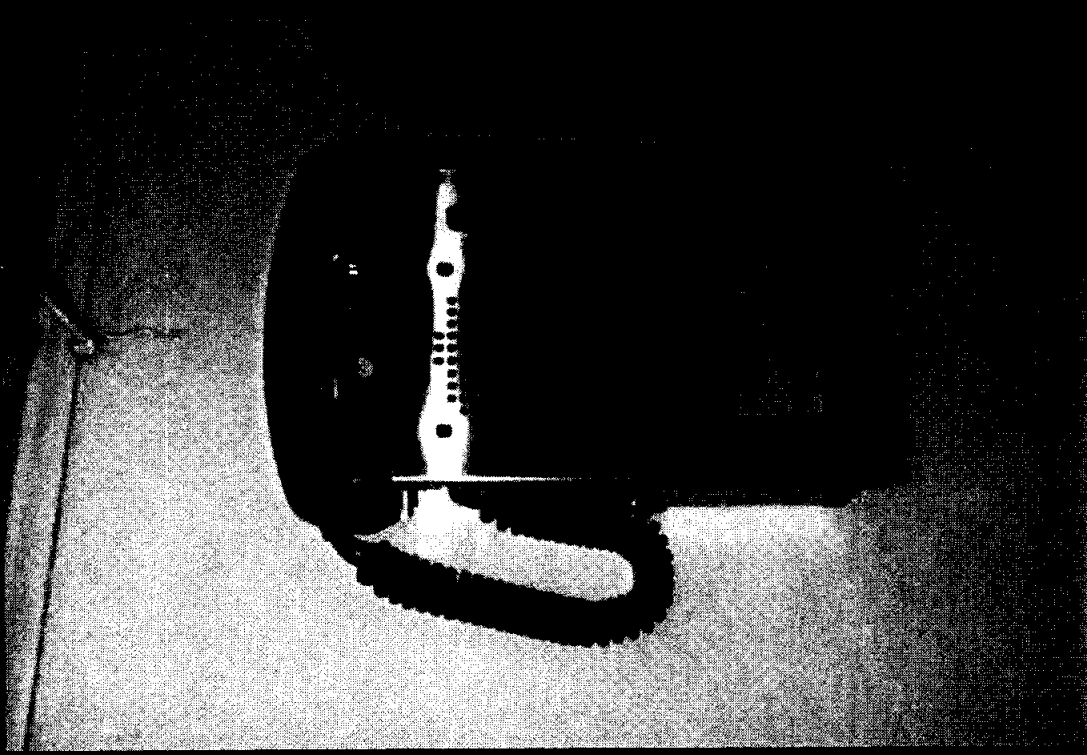

The Kennedy Chamber

Chemical Toilet

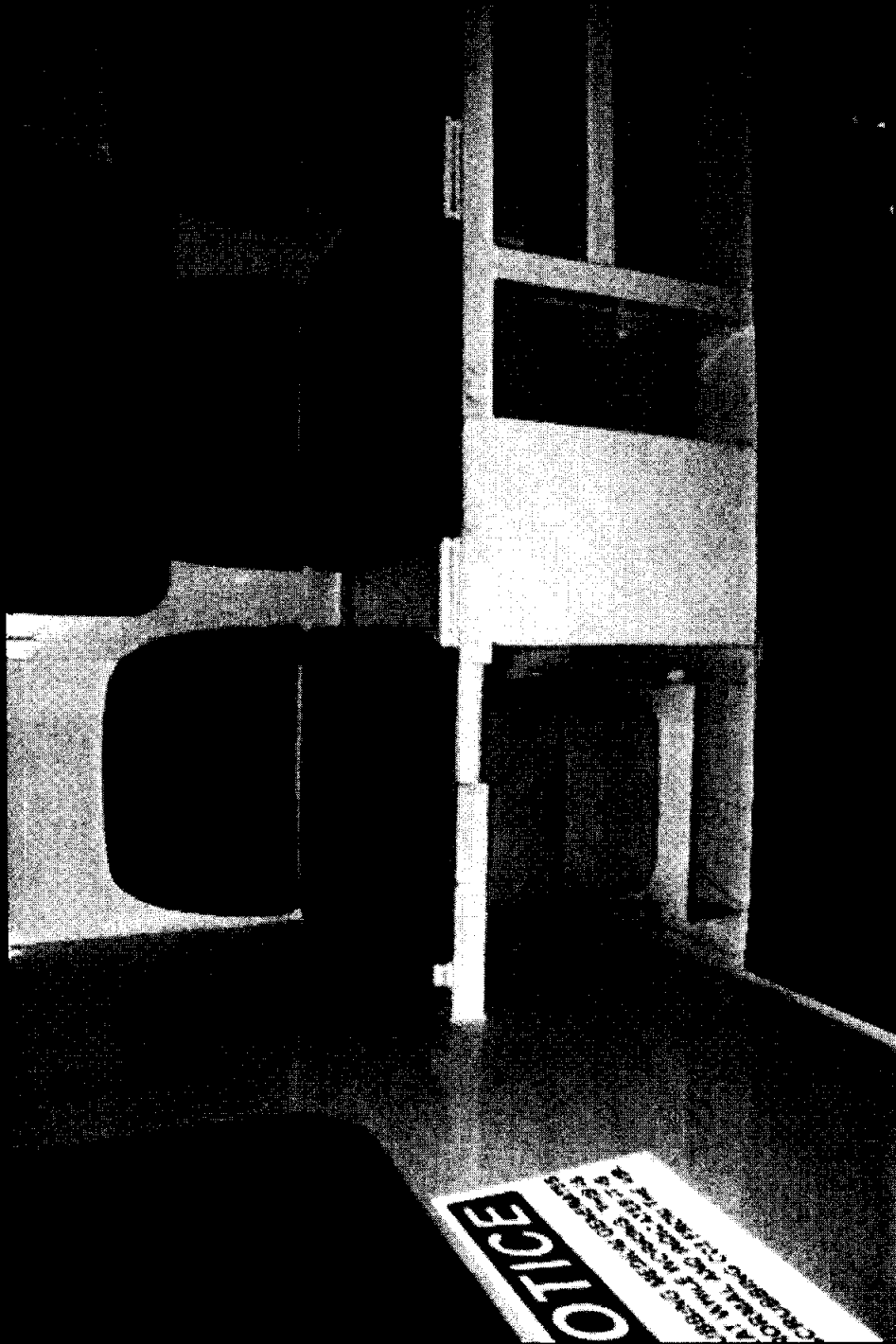

The Kennedy Chamber

Provisions

Food

Water

Reading Material

Books

Pencils

Games

300 Hour Permissible Flashlights

Light, Bright, Unobstructed Interior



The Kennedy Chamber

Gas Sampling Port



GAS SAMPLING PORT
DO NOT BLOCK

The Kennedy Chamber

Positive Pressure Relief Valve

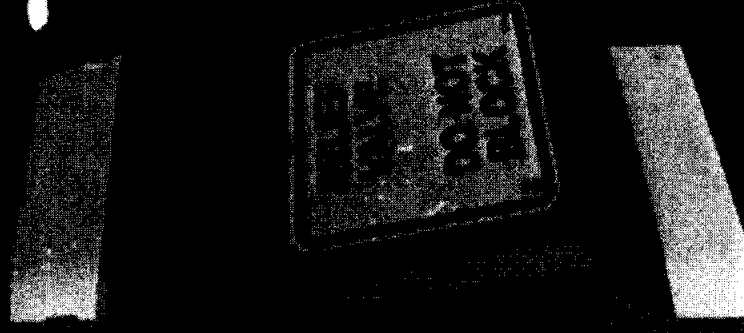

The Kennedy Chamber

First Aid

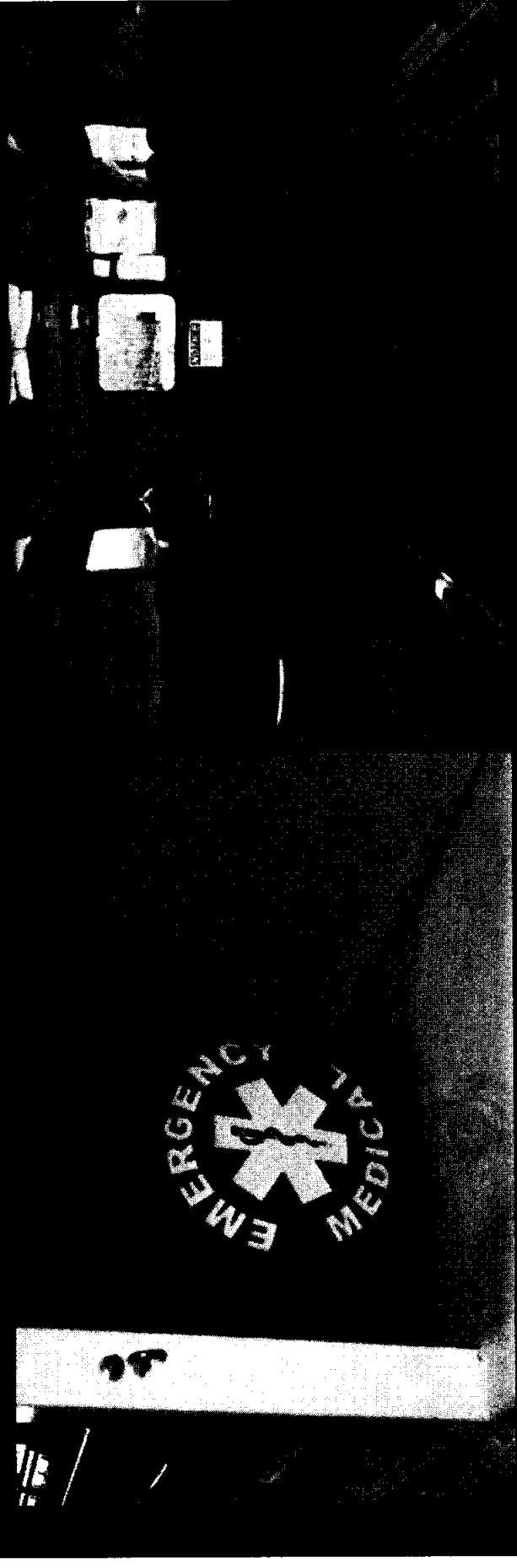

EMT Kit Plus –

- ◆ Large and Small Air Splints
- ◆ Backboard

The Kennedy Chamber

Repair Materials



Oversize SAR Acrylic Windows
Duct Tape

Training



DVD Training Materials Mobile Chamber

The Kennedy Chamber

MINE ARC

MineARC

MineARC Systems (MineARC) manufactures portable, pre-fabricated; steel mine refuge chambers and air changeover stations. Information about their systems was obtained from various internet sources (including their web page) and by contacting them directly. Information obtained from the internet sources is attached and a summary of the information obtained from James Rau (Manager, MineARC Systems America LLC) is provided below.

MineARC manufactures their chambers in Perth, Australia and is expected to open a manufacturing facility in Dallas Texas by the end of 2006. MineARC manufactures both mine refuges and air changeover stations. An air changeover station is a rigid steel enclosure that provides a supply of stored breathing units and an isolated environment to change these units out.

Mr. Rau was asked for information related to number of refuges sold, number and identity of any mines (coal and metal/nonmetal) where their refuges are located, instances where any refuges have been used, and requirements for maintenance of their refuge shelters. The following provides a summary of the information he provided in response to this inquiry.

Mr. Rau indicated they have 250 chambers placed in mines around the world. Countries include Australia, Canada, Ireland, New Zealand, Sweden, Turkey, United States, and Chile. Australian mines that use MineARC chambers include St. Ives, Newcrest, Newmont, Lionore, and Anglo Ashanti. There are 16 refuge stations currently in US mines. None of these are coal mines.

Most of these mines are metal/nonmetal but they do have a refuge chamber within a coal mine in New Zealand. The Huntly Mine is operated by Solid Energy and has one MineARC portable refuge chamber and three MineARC fresh air stations. The following is an excerpt from a 2 November 2006 James Rau email describing the use of their refuge chambers and changeover stations in the Huntly Mine:

“MineARC has a 20 person refuge chamber at the Huntly East underground coal mine in New Zealand. This mine also has three permanent refuge chambers with dedicated boreholes to the surface and compressors (it is important to note that all of these refuges are called change over stations at the mine).

The mine is owned by Solid Energy (www.solidenergy.co.nz). The mine utilizes continuous miner development with secondary extraction. Similar to the United States the miners are equipped with one hour duration SCSR. The decision to purchase a refuge chamber was to ensure a practical self escape plan from workings 4km distance from surface. It was felt that it would be unlikely that a worker could escape in impaired visibility with the limitation of 1 hour of O₂ in the reasonably steep

changeable grades worked in. It is important to remember that the 'change over stations' as they are termed are part of an escape system. The mine runs life lines the full length of the mine main intake and returns with directional cones to get you to each of the three permanent 'change over stations' and the portable one provided by MineARC.

The refuge chamber is not intrinsically safe and is thus located in the non restricted areas of the mine. It is generally located 200 meters from the face but regulations would allow 100 meters back from the last cross-cut. The mine advocates an 'escape if possible' strategy via normal transport. However, once you encounter impaired visibility the escape is staged via the three chambers provided on the main traveling road. They are spaced at approx 800m to 1Km apart. The chambers allow rest, communication with surface (via normal communication network or a direct independent feed to surface up the borehole) and a safe environment to change over self rescuer for a new one."

On NTTC has sent an email to Paul Hunt, Solid Energy's manager for the Huntly East Mine, requesting additional information on the selection criteria and use of their refuge chambers. To date, no response has been received. Any information provided by Mr. Hunt will for forwarded to NIOSH for inclusion into this report.

MineARC provided an account of a refuge being used during a fire emergency at the St Ives Leviathan gold mine in Western Australia. The refuge was used by nine mine workers for four hours until they were rescued by the emergency response team. The fire forced the mine to shut off power and air so the refuge operated under its backup battery system. Copies of articles about this incident are included in the attached literature.

Detailed inspection, maintenance and equipment replacement requirements are summarized in two attached tables provided by MineARC.



Underground Refuge Chambers





Administrative Services Division



Company Overview

- MineARC Systems is involved in providing solutions to underground safety requirements specialising in the mining and tunnelling industry
- They are the world's leading developer and manufacturer of underground Refuge Chambers and have pioneered the carbon monoxide scrubbing system for underground use.



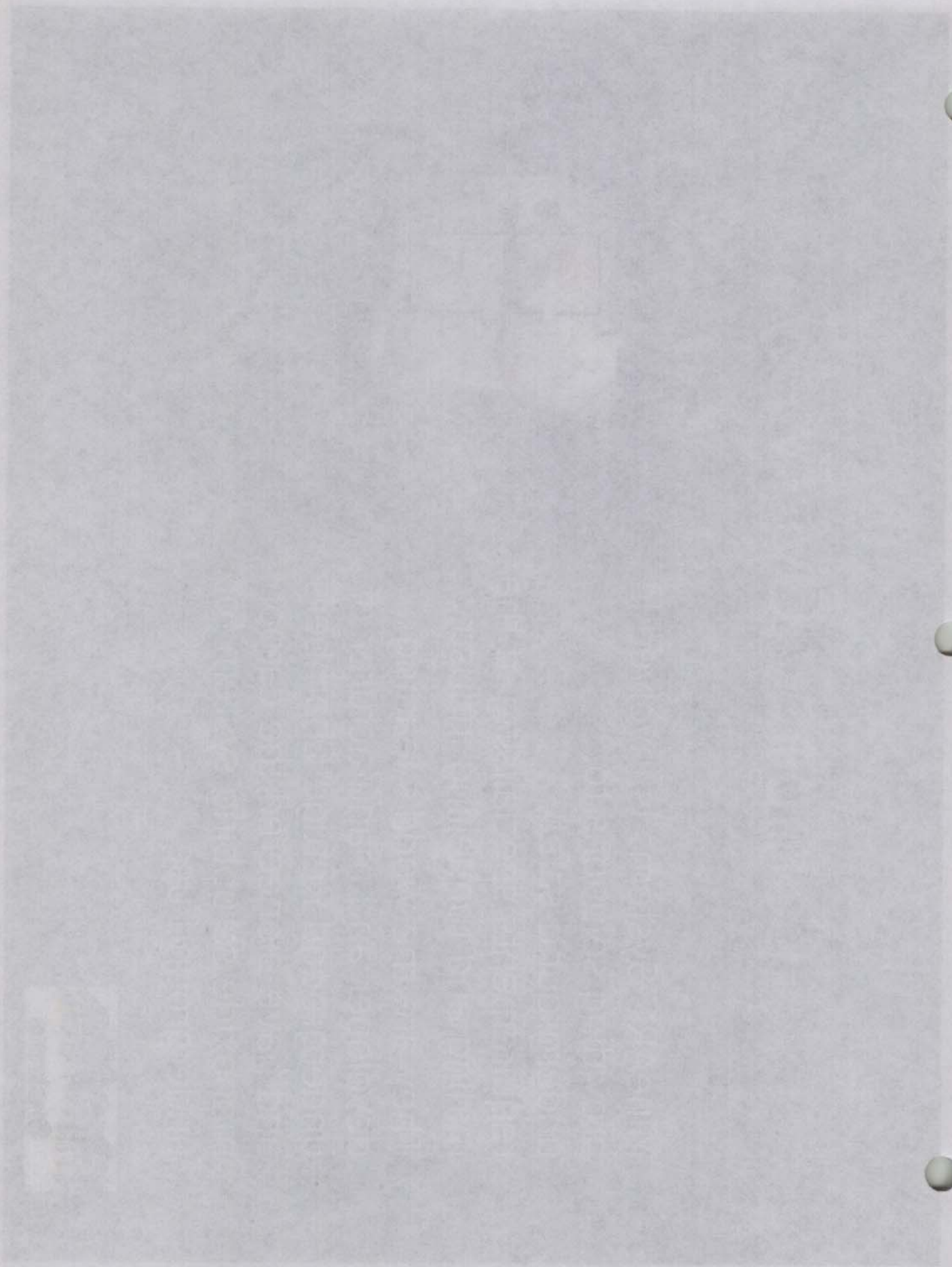

Features & Benefits

- Three Separate Systems of Air Supply
- Carbon Monoxide and Carbon Dioxide Scrubbing
- Air Conditioning System
- Full Battery Backup on all Systems
- Totally Stand Alone for 36 Hours



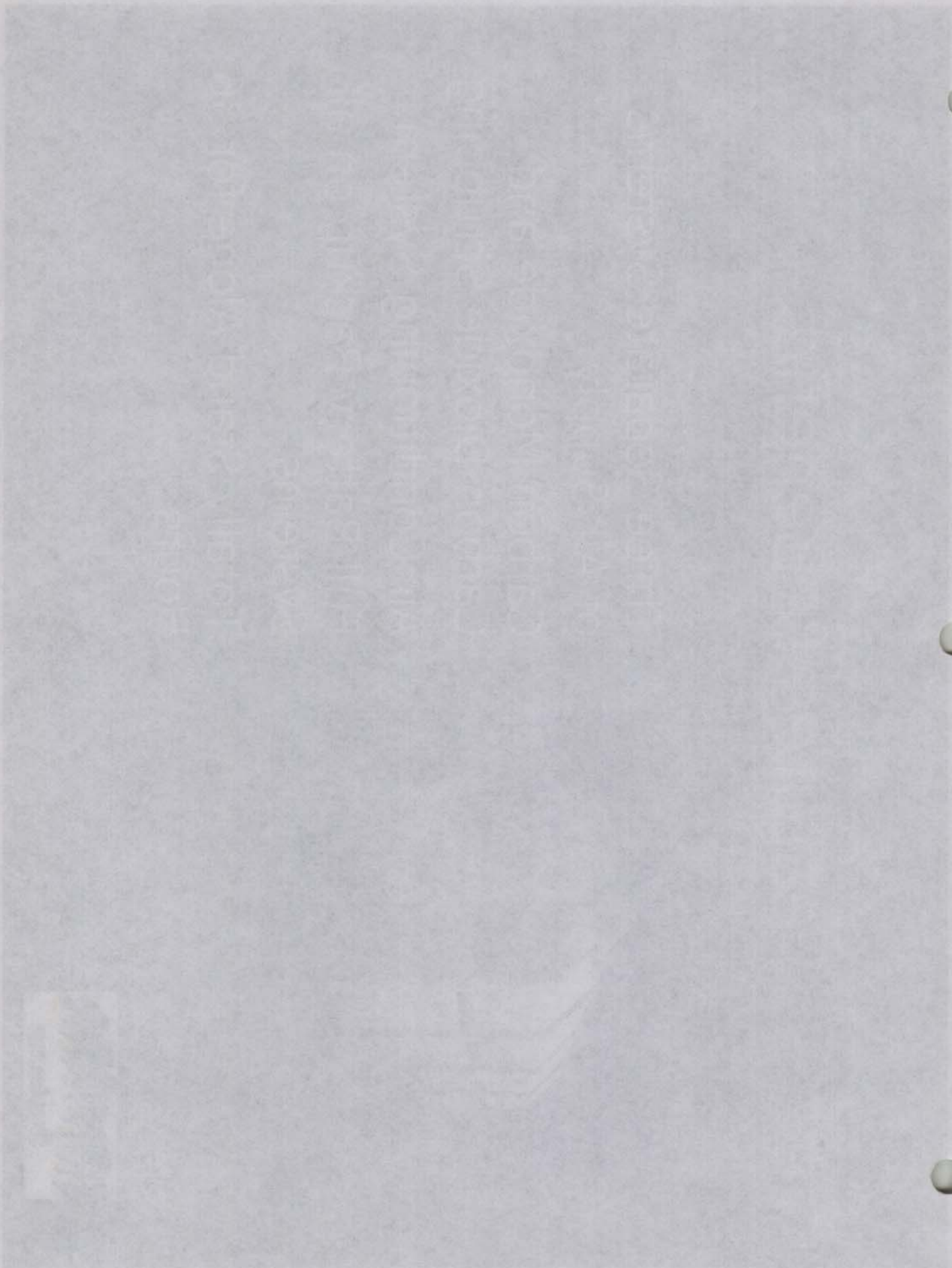

Applications

- Underground Mining
- Tunnelling
- Nuclear Waste Facilities
- Offshore Oil Platforms



MineARC Systems Refuge Chambers are installed in Underground Metalliferous Mines throughout Australia as well as Mines and Tunnels in Ireland, Indonesia, New Zealand and Turkey.





The Chamber

The chamber is a purpose built Steel Chamber designed to minimise the flow of air either into or out of the chamber once the door and air valves are sealed.



The Chamber

- Constructed of 5mm steel plate fitted with a skid base and towing and lifting points.
- Painted internally with non toxic inorganic paint and externally in industrial grade enamel.
- Escape Hatch
- Viewing Portal
- Internal & External Fire Extinguishers

Air Conditioning System

Refuge chambers must be cooled because the occupants themselves produce heat and as the heat accumulates it becomes a serious problem.

Heat build up also occurs during the scrubbing of the air.

An Air Conditioning Unit is therefore a life preserving necessity in a Refuge Chamber.



Air Conditioning System

- Air conditioning of the chamber is supplied by a split system air conditioning unit operated by Mines Power under normal conditions.
- Once the mine power fails a battery back up system will automatically run the unit.



Scrubbing System

- The CO₂ and CO Scrubbing system is in a self-contained unit designed to clean air in confined spaces where human life needs to be supported over a period of time, such as in Mine Refuge Chambers.
- The purpose is to remove the Carbon Dioxide (CO₂) and Carbon Monoxide (CO) from the air in the Chamber, reducing the risk of Carbon Dioxide and Monoxide poisoning, which can result in loss of life
-

Air Systems

The chamber is fitted with three separate breathing air supply systems:

- Filtered and silenced Compressed Mine Air
- Medical Oxygen Cylinders
- Oxygen Candle



Gas Detection System

- A Gas Sampling Pump Kit is provided with the chamber to test the Oxygen (O₂), Carbon Dioxide (CO₂) and Carbon Monoxide (CO) levels inside the Chamber. Testing the air is only required when using the Oxygen Candle or the Medical Grade Oxygen Bottles.

Electrical Systems

- The MineARC chamber is connected to an external 240-volt ac supply.
- The electrical system incorporates battery backup so that the chamber continues to operate normally even when Mine Power is interrupted.



Contact Us

For more information please see our website at
www.minearc.com.au

Or for a copy of our animated CD email us
info@minearc.com.au

Contact us at:
MineARC Systems
274 Welshpool Road
WELSHPOOL WA 6106
AUSTRALIA

Tel: +61 8 9333 4966

Fax: +61 80 9333 4900



MODERN MINE SAFETY

Modern Mine Safety Supply, LLC

Modern Mine Safety Supply, LLC (Mine Safety) is developing a portable mine refuge chamber. The chamber is a portable steel refuge chamber that contains a Refuge One Air Centre air purifier by RANA Medical (see RANA Medical for additional information on this unit). Available literature indicates that the unit can withstand a "fairly substantial secondary explosion" force. The unit is being designed specifically for coal mines. Information relating to this chamber is provided in this section.

Lynn Sitterud (of Mine Safety) was contacted and asked for information about the refuge chambers. He indicated that they are concentrating on the US coal mining market and have identified an intrinsically safe temperature control that may fit the West Virginia Taskforce recommended requirements.

In an additional email, he was asked for information about the number of refuges sold, number and identity of any mines (coal and metal/nonmetal) where their refuges are located, instances where any refuges have been used, and requirements for maintenance of their refuge shelters. To date, no response to these questions has been received. The NTTC will forward NIOSH any information provided after the issue of this report.

Modern Mine Safety Supply, LLC



MINE REFUGE CHAMBER

- Fabricated from $\frac{1}{4}$ inch steel with welded joints
- Dual sealed air locking doors
- Unit is likely to withstand fairly substantial secondary explosion forces
- Designed specifically for the unique needs of underground coal operations – and completely customizable



• Refuge One
Scrubber Unit
designed and
built by Rana
Medical

• Air
conditioning
unit is self-
contained, and
powered by 24
volt sealed cell
gel DC battery



- Completely customizable for any operations size or needs
- Intrinsic safety design process underway



- Fully portable
with wheels for
easy movement



- Fully equipped with food and water supplies
- Environmental sampling capability inside and out
- Sanitary facilities in separate compartment



Modern Mine Safety Supply, LLC



FULLY SELF-CONTAINED, MOBILE & MODERN

The cutting edge of technology to further enhance emergency response capability. Refuge chambers will provide an additional alternative to escape during mine fires or explosions.

For more details or information please contact:

Lynn Sitterud	•	435-687-2244	•	lynnspartner@yahoo.com
Kimberli Tatton	•	503-703-3922	•	mhss@comcast.net
Randy Tatton	•	801-673-1400	•	rtattonmhss@msn.com

NORTH FRINGE



THE ULTIMATE PORTABLE REFUGE STATION

WHAT YOU PUT INTO SAFETY...IS WHAT YOU GET OUT OF IT

North Fringe Resources designed the Ultimate Refuge Station beyond industry standards. From a Fire Resist Structure to double door air lock design....North Fringe Resources took safety to a new level...and then some. The Ultimate Refuge Station is easy to install, comfortable to be in, and most of all, it's designed to save lives.



The Station

- Patent pending.
- Designed beyond industry standards.
- Battery operated lighting.
- Chemical toilet.
- High-tech communication system.
- First aid supplies.
- Portable water.
- Carbon Monoxide monitored inside and outside
- CO2 detection system.
- Comfortable seating design.
- Air conditioning.
- Can be designed to your specifications.

Carbon Monoxide & Carbon Dioxide Scrubber

- Efficient and reliable air filtration.
- Removes Carbon Monoxide and Carbon Dioxide
- 40 Hour Battery Life

Double Door Air Lock Design

- Stops Gases and Smoke from entering Main Chamber
- Positive pressure to maintain gases from entering
- Air tight sealed doors
- Interlocking doors

Structure

- Heavy-duty strength.
- Fire resistant design.
- Increased safety.
- Air tight advantage.
- Increased reliability.

Dehumidifier & Air Conditioning

- Heavy-duty strength.
- Fire resistant design.
- Increased safety.
- Air tight advantage.
- Increased reliability.

Head Office Saskatchewan:

North Fringe Resources Inc.
Box 1540
Nipawin, SK
S0E 1E0
C: 1-306-530-9109
P: 1-306-862-5900
F: 1-306-862-5752
E-mail: northfringe@sasktel.net
Web: www.northfringe.com

Mexico Address:

Comercializadora de Chihuahua
A.G.S.A de C.V.
Miguel Barragan #6915
Col.Parral
Chihuahua, Chih. Mexico
E-Mail: nacho@herramientasag.com.mx
Web: www.herramientasag.com.mx
Tel. 01 (614) 4 17 65 65 con 5 lineas

Take Refuge In Our Thinking

© Copyright 2006 North Fringe Resources Inc. All rights reserved.



40 Houston Rd., Regina, SK
S4V 0G3 Canada
T (306) 530-9109
E-MAIL: northfringe@sasktel.net
www.northfringe.com

Technical Information

All Portable Refuge Stations manufactured by North Fringe Resources Inc are built according to the number of people needed for it to house and the dimensions underground. They can operate on either direct mine power or battery power.

#1. Structure

North Fringe Resource's Portable Refuge Station's structure is designed to withstand open flame and heat while remaining air tight and sealed from outside gases and smoke. The chamber is a purpose built steel chamber designed to minimize the flow of air either into or out of the chamber once the door and air valves are sealed. The chamber is constructed of steel plate pressed to form minimal joints and reduce any leakage into or out of the chamber. The roof area is minimal and slopes off to side walls. The chamber is reinforced with channel and has multiple lifting and towing points on the exterior. The unit itself has a double door entrance that allows external gases and smoke to be removed before workers enter the unit through the second door. The Portable Refuge Station is painted internally with non toxic inorganic paint and externally in industrial grade enamel.

#2. Carbon Dioxide Scrubber with Oxygen Replenishing System

North Fringe Resources Inc Portable Refuge Station does not need to connect to a compressed air supply. It generates oxygen with our CO₂ Scrubber that works like the following: The scrubber is a self-contained system that is designed to provide oxygen at controlled rates, and to remove carbon dioxide from the air in an enclosed space. The unit does not depend on the compressed air pipeline, and in an emergency does not require an external electrical source. The air within the Portable Refuge Station is "processed" by the Scrubber, as opposed to purging the Carbon Dioxide laden room air with new air from the compressed air. To effectively accomplish this, the air flow through the carbon dioxide scrubbers has to be at the same rate as required by the compressed air system. To replenish the oxygen consumed by the occupants, oxygen from high pressure cylinders is injected at a metered rate (dependent on the number of occupants) into the blower circuit. The unit operates on internal long-life batteries to operate blowers. The batteries will operate the blower(s) continuously for a minimum of 36 hours. The Scrubber has a standard built-in, stored supply of soda lime and oxygen. The capacity in hours can be extended by providing additional kegs of soda lime and cylinder of oxygen in the Portable Refuge Station. Each Portable Refuge Station's Scrubber can support the number of miners/workers in the unit for a minimum time of 36 hours.

#3. Air Conditioning

Air conditioning units within the system are battery operated as well with enough life for at least 36 hours on battery life. Our Portable Refuge Station must be cooled because the occupants themselves produce heat and as the heat accumulates it becomes a serious problem. Heat build up also occurs during the scrubbing of the air. An air conditioning unit is therefore a life preserving necessity in a Portable Refuge Station. Air conditioning of the Portable Refuge Station is supplied by a split system air conditioning unit operated by mine power. Once the



40 Houston Rd., Regina, SK
S4V 0G3 Canada
T (306) 530-9109
E-MAIL: northfringe@sasktel.net
www.northfringe.com

mine power fails the system will automatically switch to battery back up to run the unit.

#4 Humidity Controls

Humidity controlling units within the system are battery operated as well with enough life for at least 36 hours on battery life. Humidity must be controlled because the occupants themselves produce moisture and as the moisture builds up it becomes a serious problem. A humidity controlling unit is therefore a life preserving necessity in a Portable Refuge Station. Once the mine power fails the system will automatically switch to battery back up to run the unit.

#5. Electrical Systems

North Fringe Resources Inc. Portable Refuge Stations can be connected to an external ac power supply. The Portable Refuge Station electrical system incorporates battery backup so that the chamber continues to operate normally even when mine power is interrupted.

The external power is used to power the battery charger for the Carbon Dioxide Scrubbing Unit, Air Conditioning, Humidity Controls and Lighting Systems. Once fully charged, batteries provide enough power to operate for at least 36 hours.

#6. Seating

Seats are located down each side of the chamber. These are cushioned with back rests for greater comfort during occupancy. Storage is provided under the seats for chemicals, water, oxygen bottles and first aid supplies.

#7. Self Contained Toilet

A Self Contained Toilet is supplied for use in emergency situations. The toilet has a capacity of for the number of individuals that are in the Portable Refuge Station but it is important that its use be minimized as much as possible.

#8. Communication Systems

The Portable Refuge Stations are equipped with the communications system requested by the mining company that will house the units.

#9 Carbon Dioxide Detection System

The unit detects O₂, H₂S, LEL, Co₂. The detection system is battery operated.

#10. Lighting

Lighting is installed that can run on either ac or dc power.

PHOENIX CHAMBER

Phoenix First Response (a subsidiary of Micon)

Phoenix First Response (Phoenix) manufactures both in situ and portable refuge chambers. Phoenix escape shelter information was obtained from available secondary sources and primary contacts. Copies of information obtained are provided in this section.

Ian Houlison was contacted to discuss Phoenix refuge chambers. Mr. Houlison indicated Micon performs risk assessments for the mining industry and will design appropriate mine refuge chambers based on the potential risks that might be encountered (explosion, groundwater inundation, fire, etc.). The resulting refuge chamber that they design can be either built into the strata or as a stand alone pre-fabricated unit. He indicated that the best type of refuge is one that is physically built into the strata because:

- 1) It allows for the drilling of a shaft into the chamber to provide air and retrieve trapped miners and also allows the miners to be retrieved through the entrance portal;
- 2) It is less likely to be damaged during an emergency than a stand-alone unit
- 3) It can withstand other situations such as inundation and gassing-out better than a stand-alone unit.

Mr. Houlison also indicated that they design their chambers to withstand an overpressure of at least 50 psi.

Additional attempts to contact Mr. Houlison were made to obtain information about the number of refuges sold, number and identity of any mines (coal and metal/nonmetal) where their refuges are located, instances where any refuges have been used, and requirements for maintenance of their refuge shelters. To date, Mr. Houlison has not responded. If additional information is obtained, the NTTC will forward this to NIOSH.

INNOVATION



**MINE EMERGENCY,
ESCAPE & SHELTERS**



THE PHOENIX CHAMBER

UNDERGROUND EMERGENCY



INNOVATION



EMERGENCIES

Generally may be divided into three areas.

SELF ESCAPE:-

Usually involves mineworkers with "Little or no Injury" exiting the mine with a potential use of SCSR's

AIDED ESCAPE:-

Mineworkers who are injured and may be assisted by fellow workers exiting the mine or retreating to a "place of safety".

MINES RESCUE:-

This historically involves entry into an effected mine by trained personnel wearing appropriate devices to retrieve injured or trapped mine workers and restore ventilation.

(Now may also involve retrieval from a place of safety).

EMERGENCIES



FIGHT or FLIGHT RESPONSE

Danger

THE HUMAN REACTION IS TO DEFEND
LIFE OR TO ESCAPE DANGER.

- This inherited reaction is involuntary and as such requires harnessing in an underground emergency. {TRAINING}
- Trained personal are taught to SLAM or **Stop, Look, Assess and Manage** their environment.
- Underground Emergencies demand all the trained skills to come together in often hazardous environments.



INNOVATION

STEP 1



STOP ... Not so fast!



**Take a look around.
Think through the EMERGENCY.**

- Is this a life threatening event?
- Has the gases present been determined?
- Do you need the SCSR's **NOW** or later?
- Can I communicate to the surface?
- Which is the available best escape route?

STEP 2



LOOK ... *Identify the hazards for each reaction to the **EMERGENCY**.*



This step begins before any immediate reactive response occurs.

- Determine the essential steps to maintain life and property.
- Address the issue of identifying noxious or poisonous gas.
- Identify hazards for fitting SCSR's.
- Check **ALL** communication links to the surface.
- Identify any escape routes that exist under present conditions.

STEP 3



ANALYZE ... *Determine if you have the knowledge, training and tools required for the job and identify key people within your group.*



- Experience helps to identify potential hazards.
- Assessment should continue throughout the active response to the incident.
- Share identified hazards with others in your group.
- Remember two heads are better than one.

INNOVATION

STEP 4

MANAGE ... *Remove or control the hazards and use appropriate equipment.*



Utilize established control measures

- Eliminate (Remove hazard completely)
- Substitute (Re-ventilate from a fresh air source)
- Engineer (Enter an established refuge chamber)
- Administrative (Follow written response instructions)
- Personal Protective Equipment (SCSR's)

INNOVATION



TRAINING

MINE OFFICIALS ... Receive training during their years of study but may never the need to use the knowledge. The fall back then becomes the SLAM Philosophy.

MINES RESCUE Personnel receive training and practice in emergency response and utilize this knowledge on a regular basis to instill this skill indelibly.

MINE WORKERS ... Rarely receive practice in emergency response but will have a knowledge base due annual refresher training obligations.

INNOVATION

RESPONSE



THE BASIC MINES RESCUE PRINCIPLE IS:-



To provide timely, rapid intervention to emergency events that impact the United States Mining Industry

This fundamental principle has its roots in history where the concept of refuge chambers began.

This took the form of teaching the concept of barricading to mine workers awaiting rescue in small mines very dissimilar to the larger mines of today.

Simply put Mines Rescue relies on the physical strength of the trained man to effect a rescue and recovery of individuals from a hostile environment some of which may need to be carried.

INNOVATION

EGRESS FROM THE MINE



From a Refuge Chamber (place of safety) the endangered miner can:-

- Be either provide with or have an agreed safe route of egress from the mine with the available communication system.
- Retrieve additional SCSR escape devices or replenish deployed self rescuers nearing the end of their useful life.
- Retrieve stored mine plans to permit an ease of identifying egress routes either primary or secondary which ever is the safest to traveled at that time.
- Be supplied with information from the surface to aid the escape from the hostile environment and/or remain in relative safety.

INNOVATION

THE PHOENIX CHAMBER



MINES ... with established refuge chambers afford greater protection for all people underground.

MINES ... can utilize this place of safety as a major communication link to the surface and give the mine worker a safe haven to 'sit it out' if this is the required course of action.

MINES ... in an emergency response mode now have time to plan the rescue and recovery effort that is not as time critical as **MINES** who don't have refuge chambers.

INNOVATION

THE PHOENIX CHAMBER

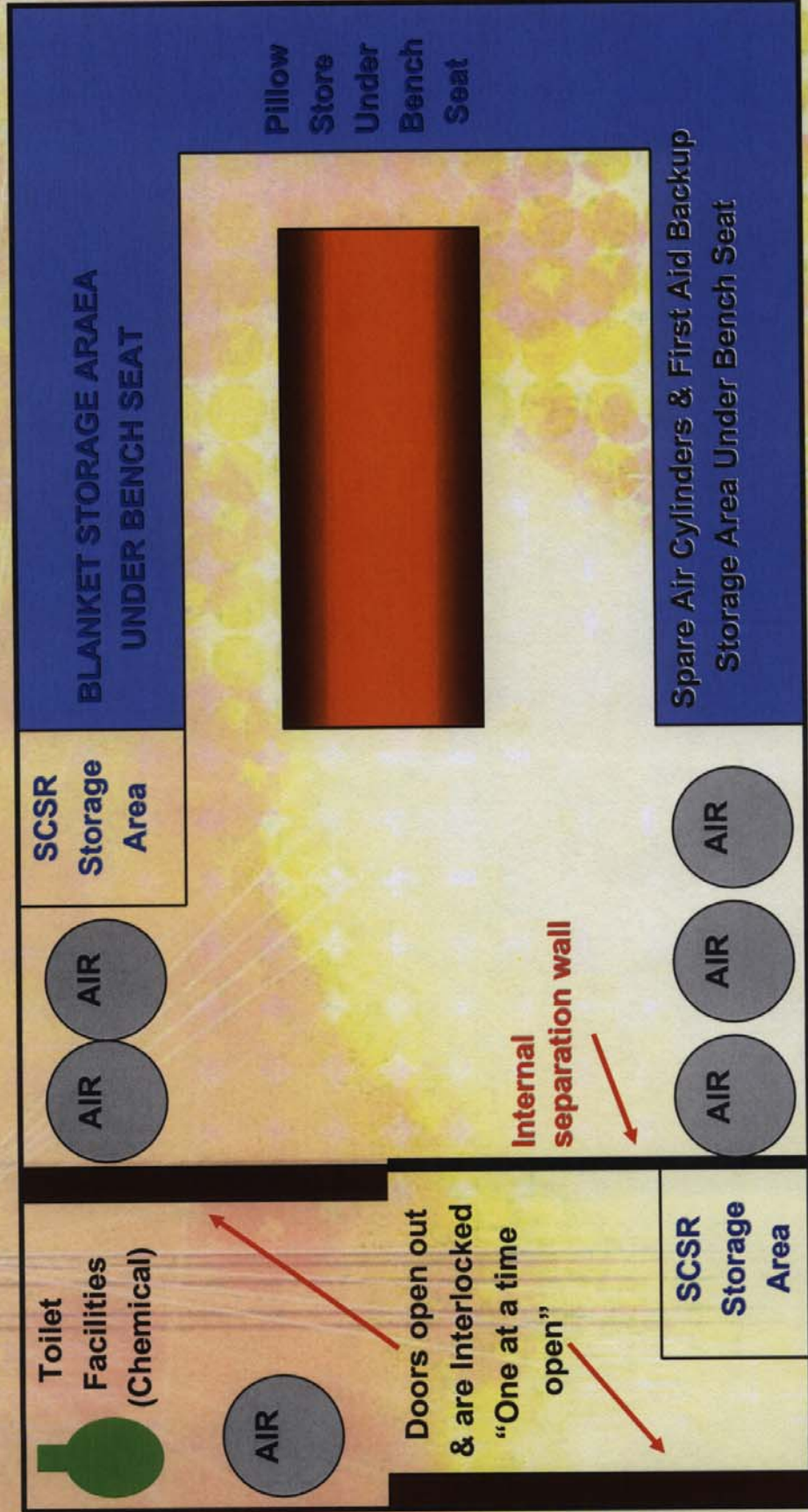

INNOVATION

THE PHOENIX CHAMBER



- The outbye door will open out to resist an over-pressure.
- The inby door will open out to give an airlock arrangement.
- All corners braced for over-pressure resistance.
- The bench seat is to be designed as storage area for additional supplies like S.C.S.R.'s, blankets, first aid supplies, EMT kit for definitive patient care, oxygen (therapy unit), etc.
- Internal wall is filled with foam for insulation and comfort.
- Interlocked entry doors to guarantee an airlock arrangement.

INNOVATION

PHOENIX FIRST RESPONSE

EASTERN OFFICE

25 Allegheny Square
Glassport, PA 15045
Phone:- 412 664 7788
Fax:- 412 664 7717

WESTERN OFFICE

1114 Sixteen Road
Fruita, CO 81521-2029
Phone:- 970 858 0600
Fax:- 970 858 0696



RANA MINING

Rimer Alco North America (RANA)-Medical

Information about the Tommyknocker Refuge Chamber (Tommyknocker) and Refuge One Air Centre (Refuge One) manufactured by RANA-Medical (RANA) was obtained from various internet sources (including their web page) and by contacting them directly. Information obtained from the internet sources is attached.

RANA has been in business since 1987 as a supplier of oxygen concentration systems. Their interest in oxygen led to their involvement in mining health and safety with the introduction of the Refuge One, a device that provides respirable air. More recently RANA began developing the Tommyknocker, a prototype stand alone portable refuge chamber.

Lyall Gardiner (Project Manager, RANA Mining Refuge Chamber Safety Systems) was contacted to provide information about their products. The following provides a summary of the information he provided in response to this inquiry.

According to Mr. Gardiner, they have sold over 90 Refuge One units world wide. Their units are capable of operating for a minimum of 36 hours without mine power or air. The following email excerpt provides a summary of the testing and use of their Refuge One:

“Our Refuge One Air Centre has been tested underground in permanent refuge stations at the Atomic Energy Research Station in Manitoba and at Falconbridge's Kidd Creek Mine in Ontario. The participants are listed in the test results which I have attached (Placer Dome was a participant). ... We have also run various demonstrations with our mobile unit, the most recently being at Hudson Bay Mining and Smelting, Potash Corporation and the recent Summit on Emergency Preparedness for Canada's Underground Mines in Winnipeg, sponsored by the Manitoba Mining Association.

We have our equipment at the Musselwhite Mine in Northern Ontario (which I believe Barrick now operates); Cameco has a number of our Refuge One's as does Falconbridge, Potash Corporation and deBeers. We have also sold a number of our units to MSA and Draeger Safety over the years. We manufacture these units in Manitoba, Canada.”

A copy of the Refuge One 1994 test report mentioned in the excerpt is included within this section. In a subsequent email, Mr. Gardiner indicated that their units have been sold in Canada, Chile, and Australia and additional clients include Canadian Gypsum and Wesdome. Many of their units are sold through distributors so he was uncertain of all of the locations of their equipment. None have been used in an actual emergency but they have been tested in simulated hard rock-type emergencies (see attached reports for additional test information). He indicated that they have not sold any units within the United States because of the high cost of product liability insurance. Additionally, they do not offer their units to coal mining because they are not intrinsically safe.

Mr. Gardiner provided information on the more recently developed Tommyknocker prototype refuge station. He indicated that it is a portable unit that can be transported by pulling or forklift and comes in a standard 10 person size that can be modified to any size. Mr. Gardiner indicated that the Tommyknocker is still a prototype and no units have been sold.

RANA-Mining

REFUGE CHAMBER SAFETY SYSTEMS

"Ensuring your Miner's Safety"

"THE TOMMYKNOCKER" MINE REFUGE CHAMBER



View our website at www.ranamedical.com or contact RANA Mining at (204) 928-1409.

" A CANADIAN COMPANY "

Tommyknocker Refuge Chamber

We build, supply and service 'The Tommyknocker' Mobile Refuge Chamber which has the following specifications:

Size	Standard unit is 14 feet long, 7.5 feet wide and 7 feet high. Capacity can be increased by increasing the length of the chamber in 4-foot sections. Can be assembled in sections underground. We can design to meet customer needs.
Capacity	14' chamber accommodates 8-10 people and each additional 4 ' section would accommodate an additional 4-5 people.
Number of rooms	2 rooms with one small room 2.5' in depth serving as the air lock room and toilet area.
Seating	Padded benches running along each side of chamber.
Storage	Located under the benches. Storage cupboard located in air lock room.
Window	Located in doors.
Toilet	Self contained 24-litre storage.
Lighting	Interior lights which operate on battery or mine power. Warning lights located outside chamber indicating batteries need charging.
Air supply	There can be two sources of air supply: 1.RANA's Refuge One Air Centre , which scrubs carbon dioxide from the chamber and regulates oxygen into it. It operates either continuously off mine power or on battery power should mine power fail. Will operate without mine power for a minimum of 36 hours. Included with 'The Tommyknocker'. 2.The mine's compressed air system. The Tommyknocker is equipped to hook up to compressed air which is filtered, pressure reduced and has a sound muffler.
Composition	Constructed of 12-gauge steel, sandblasted inside and out, epoxy primed and urethane painted. Solid steel wall divider between rooms and 2 sealed doors with secure latches.
Electrical Power	The charger has inputs of 120 VAC, 60-Hz and outputs of 12Volt DC.Other voltage and frequency available.
Air Conditioning (Optional)	Climate controlled 16,000 BTU DC powered air conditioner, wall mounted with batteries and charger mounted inside a cabinet located on floor of chamber. Controls heat and humidity. When the batteries are fully charged and running continuously (100% duty) they will have an operating time of 30 hours. If the duty cycle is 60% (running 60% of the time-which is the average) the air conditioner will operate for up to 48 hours without mine power
Weight	Approx. 4386 lbs., not including AC. 4 laser cut lifting lugs to lift down shaft. Built on skids or can be moved with a forklift.
Carbon monoxide scrubber (optional)	Size of model based on volume and concentration of CO.
Gas Monitor (optional)	Portable digital monitor to gauge carbon dioxide, carbon monoxide, heat and humidity
Water Dispenser	Supplied
Signage	Reflective signage throughout identifying Refuge Chamber.



OPERATION TOMMYKNOCKER

**Test of Survival Equipment
for Underground Refuge Stations**

at the

**Underground Research Laboratory
Lac du Bonnet, Manitoba**

March 04 & 05, 1993

by

**E. J. Gardiner
M. B. Raber, P.Eng.
Rimer Alco North America Inc.
Morden, Manitoba, Canada**

**G. W. Kuzyk, P.Eng.
R. Hawkins, MD
AECL Research
Pinawa, Manitoba, Canada**

**B. D. Simoneau, CRSP
Mines Accident Prevention Association of Manitoba
Winnipeg, Manitoba, Canada**

**R. Glassford, P.Eng.
T. Redekop, MD
W. Schubert
Manitoba Department of Labour
Winnipeg, Manitoba, Canada**

OPERATION TOMMYKNOCKER

CONTENTS

Executive Summary	
1. Introduction	1
2. System Requirements	3
3. Description of the Test	3
3.1 Purpose	3
3.2 Selection of Volunteers	3
3.3 The RANA-AIR Mine Refuge Air Centre	4
3.4 Simulated Refuge Station	5
3.5 Safety	5
3.6 Atmospheric Monitoring	6
3.7 Comfocheck System	8
3.8 Support Personnel	9
4. Test Results	9
4.1 Oxygen Levels and Measurements	9
4.2 Carbon Dioxide Levels	11
4.3 Relative Humidity	15
4.4 Temperature	20
4.5 Barometric Pressure	24
4.6 Performance of the RANA-AIR System	24
4.7 Medical Surveillance	24
4.8 Feedback from the Participants	25
4.9 Debriefing Notes	25
5. Conclusions	27
6. Recommendations	28
Acknowledgments	28
References	28
Appendix A - List of Participants	29
Appendix B - Technical Information	32
Participant Comments and Evaluation	
Letter from Dr. T. D. Redekop	
Letter from R. Sullivan	

OPERATION TOMMYKNOCKER

Evaluation of the RANA-AIR Mine Refuge Air Centre for Life Support in an Underground Refuge Station

at the

AECL Research Underground Research Laboratory
Lac du Bonnet, Manitoba
March 04 & 05, 1993

EXECUTIVE SUMMARY

Operation Tommyknocker was a test to evaluate the Rimer Alco North America Inc. "RANA-AIR Mine Refuge Air Centre," a self-contained system to maintain safe oxygen and carbon dioxide levels for personnel in mine refuge stations under emergency situations.

The evaluation demonstrated that the RANA-AIR system successfully met the test criteria and satisfied the participants and the sponsors. It maintained oxygen at 19.5 to 20.9% (minimum TLV is 18%), and carbon dioxide at less than 2300 ppm (maximum TLV is 5000 ppm) for six volunteers sealed in the refuge station for 24 hours.

The test was conducted in a small station (22 m³) so gas concentrations would change rapidly. During the first half hour, before the RANA-AIR system was activated, the volunteers were very busy organizing themselves. This activity produced a sharp increase in carbon dioxide concentration. However, shortly after the system was activated, the carbon dioxide was brought under control. The participants found the RANA-AIR system to be "simple and easy" to use. They turned it on, set the oxygen flow, and had no need to make further adjustments.

Carbon dioxide and oxygen gas measurement tubes were used by the volunteers for monitoring. The carbon dioxide tubes worked well, but readings from the oxygen tubes were variable in this application, possibly because of the high humidity. The volunteers also used a Comfocheck instrument developed by AECL Research to measure carbon dioxide, temperature and relative humidity.

The evaluation was performed under the leadership of the Mines Accident Prevention Association of Manitoba (MAPAM) and the Mines Inspection Branch of the Manitoba Department of Labour. They developed functional requirements for the equipment and the evaluation criteria. Rimer Alco developed the RANA-AIR Mine Refuge Air Centre for testing. AECL Research provided a simulated mine refuge station at the 240-metre level in the Underground Research Laboratory facility near Lac Du Bonnet, Manitoba. Six

volunteers from sponsoring MAPAM mining companies used the RANA-AIR system under actual underground conditions.

All the participants were extremely satisfied with the performance of the RANA-AIR Mine Refuge Air Centre. They agreed that it has the potential to enhance mine safety in an emergency situation, and that Rimer Alco should be encouraged to continue development of a production model.

OPERATION TOMMYKNOCKER

Evaluation of the RANA-AIR Mine Refuge Air Centre for Life Support in an Underground Refuge Station

1. INTRODUCTION

Changes in technology and mining methods prompted a review of the requirements for underground refuge stations by the Mines Inspection Branch of the Workplace Safety and Health Division, Manitoba Department of Labour (Mines Inspection Branch), and the Mines Accident Prevention Association of Manitoba (MAPAM). The demand for traditional mine services such as compressed air, water, electricity and communication systems have changed dramatically over the last decade. The introduction of equipment utilizing electric/hydraulic power is rapidly replacing pneumatic equipment, thereby reducing or eliminating the need for compressed-air lines in many workplaces underground. In the absence of compressed-air lines, alternate methods must be established to provide respirable air for refuge stations.

The directors of the MAPAM and representatives from the Mine Inspection Branch defined the operational requirements for an underground refuge station air supply system and developed an evaluation test for the proposed system. The test was to be called Operation Tommyknocker. The name "Tommyknocker" was derived from mining folklore. Tommyknockers are the spirits of trapped miners knocking for food and rescue.

Rimer Alco North America Inc. (Rimer Alco) developed the RANA-AIR Mine Refuge Air Centre according to the directors' requirements. The system was designed to add oxygen and remove carbon dioxide from the atmosphere in an underground refuge station containing trapped personnel. The system was also designed to be rugged, simple and totally self-contained.

Rimer Alco's involvement in Operation Tommyknocker was the result of their interest and awareness of the problem defined by the MAPAM directors and personnel from the Mines Inspection Branch as well as their interest in providing a solution to a potentially dangerous situation.

The directors arranged to have Operation Tommyknocker conducted in a simulated mine refuge station at AECL Research's Underground Research Laboratory (URL) near Lac du Bonnet, Manitoba. AECL developed the URL to carry out geotechnical research relating to the disposal of used nuclear fuel in the plutonic rock of the Canadian Shield. The URL is an important part of the Canadian Nuclear Fuel Waste Management Program and is ideally suited to carry out research projects and tests such as Operation Tommyknocker.

AECL Research's participation in providing a location, professional staff and the many services required for this type of test was done in the true spirit of cooperation. As a member of MAPAM, AECL Research also expressed a keen interest in participation to ensure "safe underground refuge stations."

The simulated refuge station was constructed in a dead-end tunnel in Room 207 on the 240-m level of the URL. The station was approximately 22 m³ in volume (3.0 x 3.0 x 2.5 m). Six volunteers, representing the types of workers normally found in the mine environment, were isolated in the simulated refuge station and used the RANA-Air Mine Refuge Air Centre for a 24-h period. Technical and medical staff were present in the tunnel outside the refuge station during the test to observe the volunteers and gather environmental and physiological data.

The volunteers were mine personnel from participating MAPAM member companies. MAPAM is a nonprofit organization funded primarily through the Mining Association of Manitoba by the mining companies, mine contracting companies and diamond-drilling companies operating in the Province of Manitoba. Two participants were sent by INCO from Thompson, two were sent by Hudson Bay Mining and Smelting Limited (one from Flin Flon and one from Leaf Rapids), two were provided by The Tantalum Mining Corporation of Canada Limited (Tanco), Lac du Bonnet, and two were provided by AECL Research.

2. SYSTEM REQUIREMENTS

The requirements of the air supply system were defined by the Mines Inspection Branch and MAPAM with the objective of providing a safe respirable refuge environment for confined personnel. It was determined the equipment should:

1. Control oxygen and carbon dioxide concentrations as close to normal levels as possible or at least to nationally accepted safe levels.

For the evaluation test, the carbon dioxide concentration should be less than the TLV-TWA value of 5000 ppm, and oxygen should be greater than 18%, so the volunteers would not be at risk.

2. Operate without reliance on electric power or compressed air from outside the refuge station for at least 24 h in an emergency situation.
3. Be simple and easy to operate with a minimal training.
4. Be durable and rugged, with a long stand-by life (i.e., years) without use and be able to stand up to the severe environmental conditions present underground, such as cool temperatures, high humidity and concussion from blasting

operations.

5. Affordable cost so the system would be feasible in any mine's safety program.

3. DESCRIPTION OF THE TEST

3.1 Purpose

The purpose of the test was to evaluate how well the RANA-AIR system would meet the requirements defined by the Mines Inspection Branch and the MAPAM directors, and to demonstrate its operation under realistic underground refuge station conditions.

Rimer Alco's objectives going into the test were to:

1. Determine how "simple and easy" the RANA-AIR system is to use.
2. Test the RANA-AIR system's ability to maintain oxygen and carbon dioxide levels as close to atmospheric as possible in underground refuge station conditions.
3. Determine if the monitoring equipment provided with the RANA-AIR system (to measure concentrations of oxygen and carbon dioxide) is effective and appropriate given the experience, training and anxiety of those required to operate it.

The unit had previously been tested by Rimer Alco staff on the surface in a small sealed room simulating a refuge station. To obtain baseline information and to verify the information obtained from the reference literature on rates of oxygen consumption and carbon dioxide production, nine men stayed in the room without adding oxygen or removing carbon dioxide. The results from this preliminary test generally agreed with data from the literature and confirmed the theoretical predictions.

3.2 Selection of Volunteers

Eight volunteers, who were experienced in Manitoba mine rescue procedures, were selected by MAPAM for the test. The volunteers were representative of the type of workers normally found in the underground environment. Prior to the start of the test, six of the eight volunteers were selected for enclosure in the simulated refuge station by the medical doctors during a pre-test medical examination. A briefing was carried out for the participants to explain the purpose of the test. Once they fully understood the operation, the volunteers signed consent forms. The volunteers were briefed on the operation of the monitoring equipment they were to use within the simulated refuge station and the operation of the RANA-AIR system immediately before the start of the test.

3.3 The RANA-AIR Mine Refuge Air Centre

The RANA-AIR system was a prototype unit built to evaluate the simplicity and the effectiveness of this type of equipment under emergency conditions. The system was intended to be rugged and easy to maintain. Measuring 160 mm high, 65 mm wide, and 90 mm deep, it had the capability of sustaining 10 people at rest for 36 h. Systems having a greater capacity can also be made available.

The six volunteer participants were sealed in the simulated refuge station at about 1300 on March 04. They organized themselves and started the RANA-AIR system about half an hour after entering the station.

The oxygen flow rate was set by the volunteers according to their demand. A nominal flow rate of 0.5 L/min per person was set for the test. The oxygen flow from the system was mixed with room air. The room air was circulated by a fan through a built-in carbon dioxide scrubber, which removed carbon dioxide from the atmosphere. Carbon dioxide is a product of breathing and would otherwise build up when the volunteers were confined within the sealed room.

The RANA-AIR system was totally self-contained. The volunteers only have to fill the carbon dioxide scrubber and turn on the oxygen and scrubber. Power was provided by a durable battery that is kept charged when the unit is on standby. The system was designed to be simple and easy to understand so that special skills were not required for its operation. Simple step-by-step instructions requiring a minimum level of training was all that was necessary to operate the system.

Draeger gas measurement tubes were provided as part of the system to monitoring the oxygen and carbon dioxide levels within the refuge station. The volunteer participants were instructed to make adjustments to the oxygen flow of the system based on the oxygen levels measured with the detection tubes. Carbon-dioxide-absorbing material would be changed if the absorber indicated saturation. The object was to maintain oxygen and carbon dioxide levels as close to normal atmospheric conditions as possible (i.e., 20.9% oxygen and less than 0.5% carbon dioxide).

This measurement method was selected because of the long shelf-life of the detection tubes, the ease of use, and measurement tubes are common in underground operations.

Components of the RANA-AIR system were selected for reliability and long standby life. The system was designed for easy maneuvering by personnel with the durability to withstand the ruggedness required for underground transport. It was intended the system would have a minimum 10-year life expectancy, with only periodic checks required.

3.4 Simulated Refuge Station

The simulated refuge station was constructed in a dead-end stub drift on the 240-m level of the URL. It consisted of a room with an excavated volume of 22 m³ and dimensions of about 3.0 x 3.0 x 2.5 m. An air-tight wall was constructed of nominally 2 x 6 inch lumber, three-quarter inch plywood and plastic film. The room was large enough to accommodate two sets of bunks on either side, thereby providing four beds for sleeping. Two shelves were provided on either end of the room, one above the door. A small Plexiglas window, about 300 x 300 mm, was provided in the wall. A double-door air-lock was provided in the wall to provide an area of about 1 X 1 m.

The normal breathing of the participants resulted in quick changes of oxygen and carbon dioxide levels of the atmosphere within the confined space of the simulated refuge station.

Accessories within the simulated refuge station consisted of blankets, pillows, individually wrapped sandwiches, muffins, chocolate bars, juice, coffee, cards, magazines and TV and video player. A portable toilet was placed within the entrance air lock to provide privacy and control odour.

3.5 Safety

The purpose of the test was to evaluate the performance of the RANA-AIR system, not the reaction of the participants to confinement and isolation. The participants were volunteers who were healthy, free from any medical afflictions, and typical of individuals normally working underground. The following guidelines were used to select the participants:

1. normal vital signs,
2. normal heart and lung function,
3. normal mental psychological status (no phobias),
4. free from need to take medication, and
5. non-smokers.

Pre-test and post-test medical examinations of the volunteers were carried out by the two medical doctors involved in the test.

Technical representatives and a medical doctor were present during the entire test to ensure the necessary monitoring of the simulated refuge station atmosphere was carried out on a continuous basis and that the health of the participants was not jeopardized during the test. Before the test commenced, it was decided that the test would be aborted at any time if the participants felt threatened, wanted to leave the simulated refuge station, or the medical doctor felt the conditions were becoming a threat to their health or otherwise hazardous.

The atmosphere of the simulated refuge station was monitored during the test by the volunteer participants from within the

station and independently by observers located outside the station. The atmosphere was maintained within the Threshold Limit Value (TLV) identified in the Manitoba Mining Regulations. Oxygen levels were not allowed to drop below 18.0% [1] and the carbon dioxide level was not allowed to rise above 0.5% [2] for more than one-half hour during the test. The short-term exposure limit is 5000 ppm [2].

It was intended that the test would not push the equipment to its limit or endanger the safety of the participants. The RANA-AIR system was designed with an oxygen supply for 360 person-hours. For six people, this would be 60 h in the anticipated mine refuge station conditions. The carbon dioxide absorber system had a capacity to operate for 144 person-hours. Enough absorber was placed within the simulated refuge station to fill the system twice, giving a total duration of 288 person-hours. For the purposes of Operation Tommyknocker, the system was set up to accommodate six people for a minimum of 48 h, or twice the maximum duration of the test.

The capacities are based on the selected values of 0.5 L/min oxygen and carbon dioxide per person. The nominal values cited in the literature for astronauts or submariners are 0.42 L/min oxygen and 0.35 L/min carbon dioxide [3]. These values are for people at rest or subject to little physical activity. Strenuous exercise will result in higher values. The selected values are greater than the nominal values to allow for any stress that may have arisen during Operation Tommyknocker because of the confined space.

Individual monitoring of all participants during confinement was carried out by one of the participants who was a Emergency Medical Assistant 1 (EMA-1). The following vital signs were recorded at regular intervals (i.e., about 1-h intervals):

1. blood pressure,
2. pulse, and
3. respiration rate.

A personal log was kept by each of the participants to record changing conditions within the simulated refuge station and his own physical and mental status (e.g., to note such things as drowsiness, odours, fumes, physical changes, mental attitude).

3.6 Atmospheric Monitoring

Continual monitoring of the atmosphere inside the simulated refuge station was provided for the following parameters:

1. oxygen level (%),
2. carbon dioxide level (% , ppm),
3. temperature (°C), and
4. relative humidity (%).

Measuring equipment used inside the refuge station by the volunteers consisted of a Comfocheck instrument for measuring carbon dioxide concentration, temperature and relative humidity, and a sling psychrometer for measuring relative humidity. The Comfocheck unit, which was located on top of the RANA-AIR system near the scrubber outlet, was set to record data every 16 s.

Manual monitoring of oxygen and carbon dioxide concentrations was carried out by the volunteer participants with gas tubes as well. Draeger gas measurement tubes were used to detect oxygen and Gastech tubes were used for carbon dioxide.

In addition, the volunteers provided other equipment from their respective mines, including an Industrial Scientific system (for oxygen concentration measurements) and a Kanomax system (for temperature and relative humidity).

A second Comfocheck instrument, located inside the simulated refuge station on a shelf beside the window, was connected via a cable that passed through a sealed hole to a computer located outside. This Comfocheck unit was set to record carbon dioxide concentration, temperature and relative humidity automatically every 5 min.

Two sampling tubes were passed through sealed bulkhead fittings in the Plexiglas window. The intake for one tube was located adjacent to the Comfocheck instrument on the shelf near the top of the door, while the other sampled from the output of the carbon dioxide scrubber. Valves located at the bulkhead were used to seal the tubes when not in use for measurement. The tubes delivered sample air to two Servomex model 571 oxygen analyzers used to measure oxygen concentrations. The oxygen analyzers were calibrated with tanks of nitrogen (0% oxygen) and 100% oxygen. A Gastech carbon dioxide analyzer (range 0 - 5000 ppm) was used to measure carbon dioxide. The carbon dioxide analyzer was calibrated against a Comfocheck analyzer before the test began.

A third Comfocheck instrument was set up outside the simulated refuge station to monitor the outside atmosphere at the 240-m level. This unit also recorded data every 5 min.

A mercury barometer was installed to record changes in atmospheric pressure outside the refuge station. A water manometer was installed through the window located in the wall of the station to monitor any difference in pressure inside and outside the refuge station. Pressure readings and humidity measurements made with the sling psychrometer were recorded every hour.

Dale thermistors (Model IC-3001-C3) coupled to a switch box and precision ohmmeter were used to monitor temperatures at various locations within the simulated refuge station and outside the station. The thermistors were placed as follows:

1. Thermistor T1 was suspended from the back of the simulated refuge station about 150 mm from the rock surface.

2. Thermistor T2 was located 1.5 m above the floor about 150 mm from the back wall of the simulated refuge station.
3. Thermistor T3 was located 150 mm above the floor near the back wall of the simulated refuge station.
4. Thermistor T4 was located at the in-flow port of the RANA-AIR system.
5. Thermistor T5 was located at the out-flow port of the RANA-AIR system.
6. Thermistor T6 was located outside the simulated refuge station, under one of the tables, about 750 mm above the floor.

3.7 Comfocheck System

The Comfocheck Model I101-A system was developed by AECL Research. The system is designed to monitor the climate in an indoor working environment. The system measures the following parameters:

- | | | |
|-----------------------|------------|----------------|
| 1. Temperature: | range | -10 to 40°C, |
| | accuracy | +/- 0.5°C, |
| | resolution | 0.2°C. |
| 2. Relative Humidity: | range | 10% to 90% RH, |
| | accuracy | +/- 3.5%, |
| | resolution | 1% RH |
| 3. Carbon Dioxide: | range | 0 to 4500 ppm, |
| | accuracy | +/- 100 ppm, |
| | resolution | +/- 50 ppm. |

The Comfocheck system was designed for users who are not necessarily specialists in this field. The system weighs about 912 g and has dimensions of 215 x 140 x 60 mm. It consists of an instrument case, software for a desk or laptop PC and a cable to link the instruments to a personal computer. This system makes indoor climate monitoring practical and economical.

Temperature is sensed by a platinum resistance temperature device, relative humidity by a capacitance sensor and carbon dioxide concentration by a patented infrared absorption cell. Each sensor and its associated circuit are individually calibrated before the Comfocheck is shipped.

The Comfocheck instrument can be operated in either a "spot-check" or a "data-log" mode. The spot-check mode is used to quickly evaluate the current conditions. The data-logging mode is used to determine how the indoor climate varies over longer periods of time without the need for an operator to record the data.

All three Comfocheck instruments were calibrated on the afternoon

of March 03, the day before the test, using standard calibrating procedures. Carbon dioxide response was calibrated using three standards, 0, 876 and 3950 ppm. Relative humidity readings were calibrated at two levels, 33% and 75% RH. A linear relationship between the output and the RH is specified by the manufacturer. The temperature response was calibrated against thermistors over the range of 5 to 35°C, and was rechecked against a high-precision glass thermometer at room temperature. Immediately prior to the start of the test, the carbon dioxide response was verified at 500 ppm and was verified again at the end of the test using 2000-ppm standards. Instruments inside the refuge station were within specifications both before and after the test. The instrument outside the station showed a slightly lower value (1875 ppm) than expected for the 2000-ppm standard. As these outside data are only of secondary importance, the data were not corrected for what appears to be a very slight drift in the results. The Gastech carbon dioxide analyzer was calibrated to the reading of a calibrated Comfocheck instrument to ensure measurement consistency.

3.8 Supporting Personnel

The following personnel were required to support the test over the 24-h period:

1. Two medical doctors.
2. Two surveyors to record data outside the simulated refuge station.
3. MAPAM representative/test supervisor.
4. Three Department of Labour representatives.
5. Two record keepers/inspectors.
6. Two Rimer Alco representatives.
7. One photographer/video operator.

4. TEST RESULTS

4.1 Oxygen Levels and Measurement

The RANA-AIR system was turned on about 26 min after the start of the test. The volunteer participants set the oxygen flow rate at the value recommended by Rimer Alco in the operating directions at this time (0.5 L/min per person), and after one small adjustment to the flow rate, did not make any further setting adjustments for the duration of the test. Figure 1 shows the oxygen levels over the 24-h duration of the test. The oxygen level remained quite stable, between 19.5% and 20.9%.

Some difficulty with the oxygen detection tubes was experienced during the test. The detection tubes provided reliable readings of oxygen levels at the beginning of the test. However, after about 6 h, the detection tubes indicated oxygen levels as high as 26%. This difficulty may have been related to the humidity inside the simulated refuge station, which reached a very high level

PERFORMANCE OF RANA-AIR CENTRE TOMMYKNOCKER TEST 1993, MARCH 4 - 5

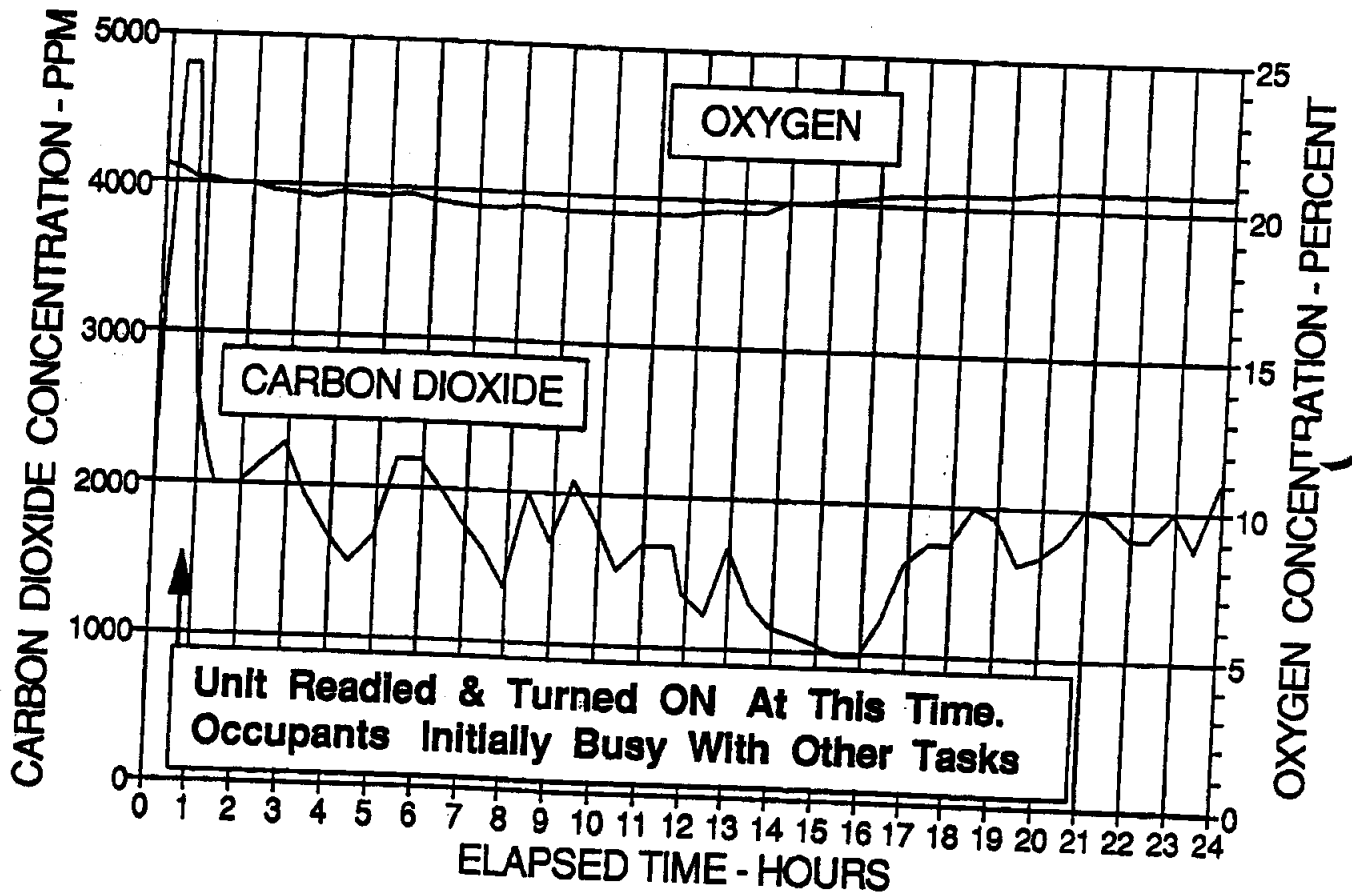

Figure 1

(about 90%) after about 2 h. The oxygen measurement was made using a dryer tube connected before the measuring tube. It was intended that each dryer tube be used with four measuring tubes. Initially, the volunteer participants were able to use from one to three measurement tubes with each dryer tube before the oxygen level readings became erratic.

The volunteer participants felt very comfortable during the test and experienced no desire to change the oxygen flow rate on the RANA-AIR system after the initial setup.

4.2 Carbon Dioxide Levels

As shown in Figure 1, carbon dioxide levels increased rapidly upon commencement of the test. The analyzers saturated at about 4800 ppm, but the peak level was actually greater. This was because there was some delay, about 26 min, before the volunteer participants started the RANA-AIR system operating. During this time they were very active while organizing themselves and arranging everything inside the refuge station. Within 7 min after the RANA-AIR system was started, the carbon dioxide level was reduced to 5000 ppm.

The initial high carbon dioxide spike was logged to off-scale readings at 16-s intervals, and these data are plotted in Figure 2. From this plot it is apparent that the carbon dioxide level reached 8000 ppm, which can be attributed to the delay in starting the RANA-AIR system. The value of 8000 ppm was within the short-term TLV of 30 000 ppm [2]. The volunteer participants all reported that they experienced a slight headache at this time. However, once the RANA-AIR system was operating, the carbon dioxide levels quickly reduced to a stable level of about 2000 to 2300 ppm. The volunteer participants reported that their headaches did not persist once the system was turned on.

After about 18 h of operation, about 1 cm of the carbon dioxide adsorbing material started to change its colour to a slightly pinkish tinge.

The carbon dioxide levels fluctuated between 1000 ppm and 2300 ppm during most of the test. It was noted that the levels were lowest 8 to 18 h after the test commenced, at times when some or all of the volunteer participants were sleeping.

The gas detection tubes used to measure carbon dioxide levels worked effectively during the test.

Figures 3 and 4 show the Comfocheck data for the units located beside the window and on top of the scrubber respectively. An absolute agreement between the two instruments inside the simulated refuge station should not be expected because the units were sampling different areas. Occupants exhaling in the vicinity of one instrument or the other would cause local maxima. However, as seen in the two figures, the two instruments do track each other very closely, rarely differing by more than 200 ppm.

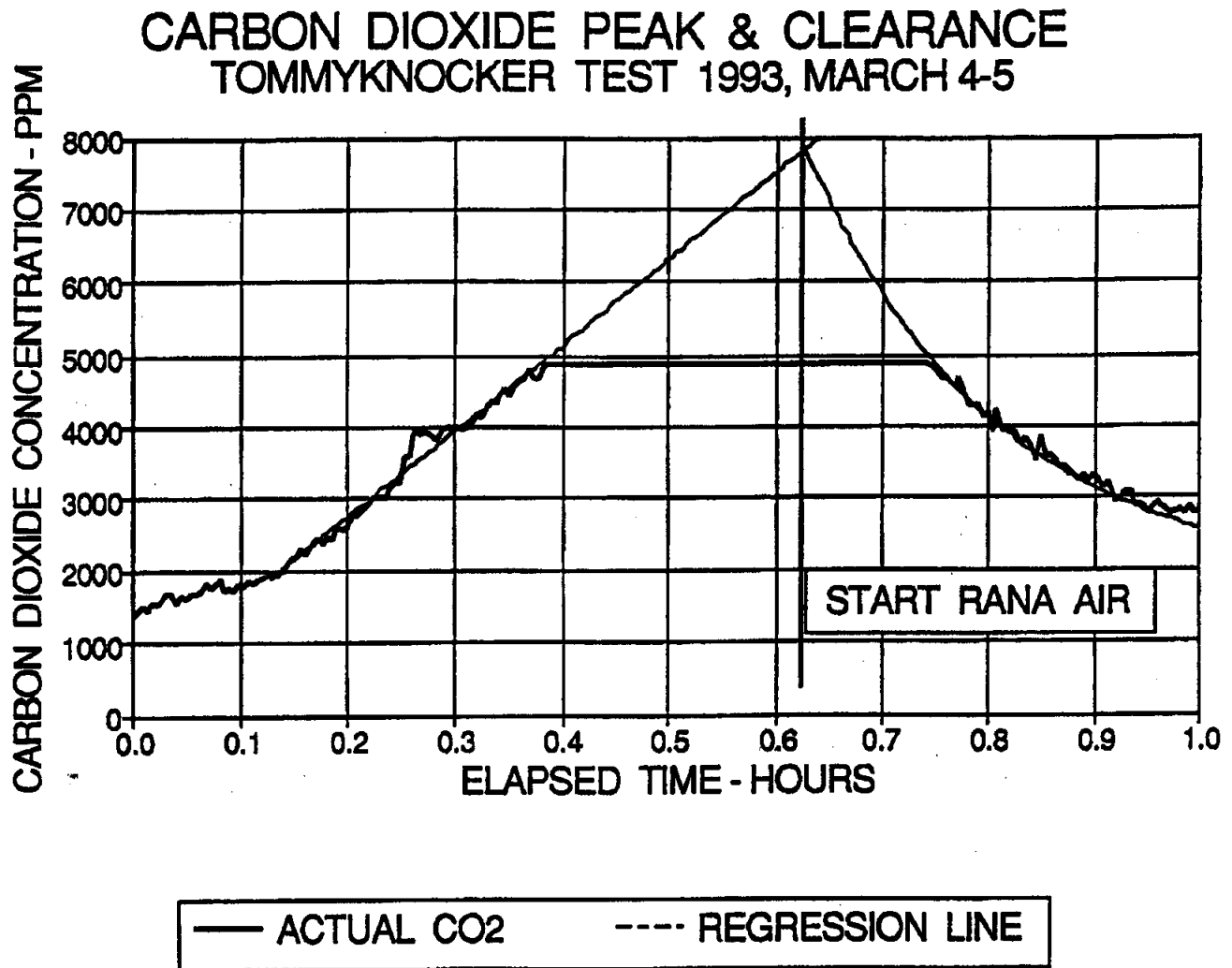

Figure 2

COMFOCHECK LOG CARBON DIOXIDE
TOMMYKNOCKER TEST 1993, MARCH 4-5

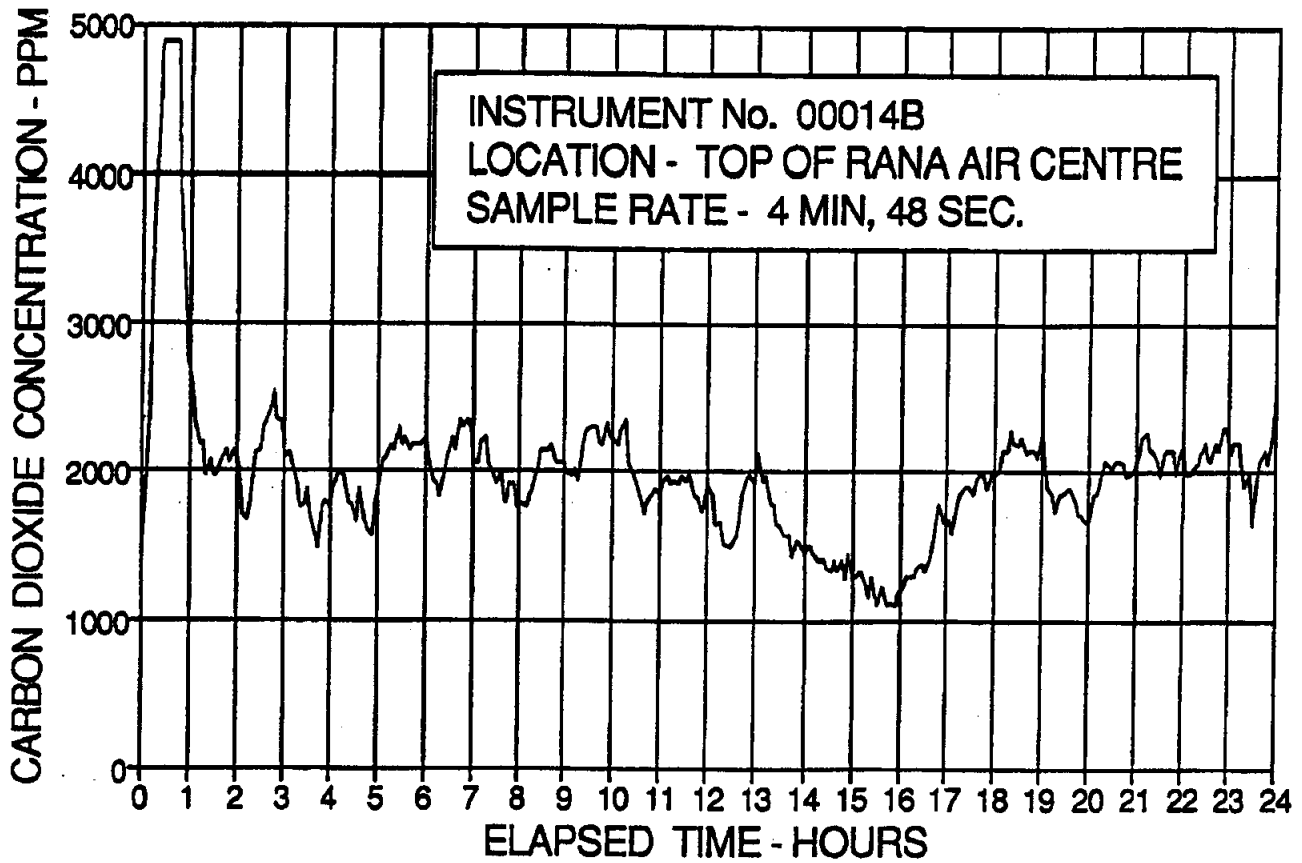

Figure 3

COMFOCHECK LOG OF CARBON DIOXIDE
TOMMYKNOCKER TEST 1993, MARCH 4-5

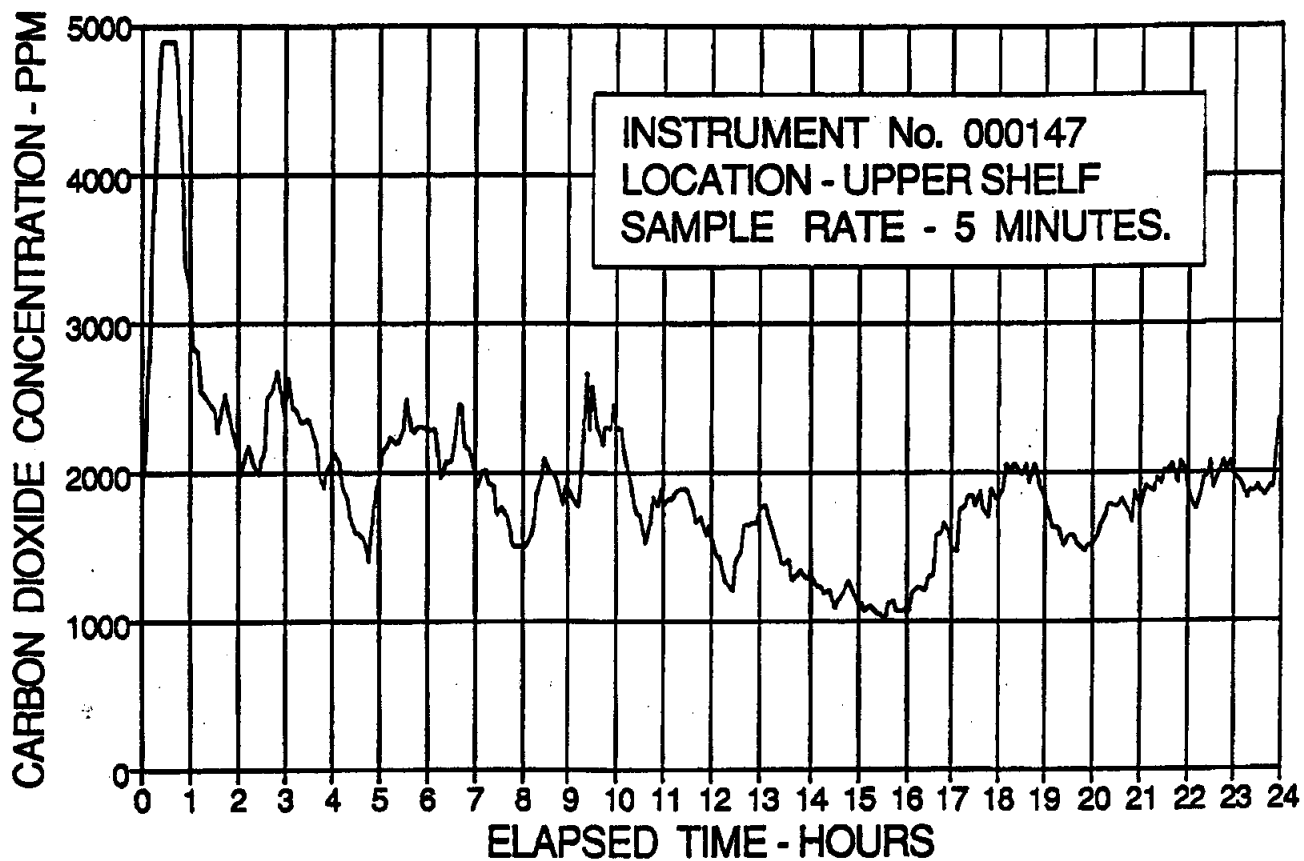

Figure 4

The carbon dioxide levels outside the simulated refuge station were about 800 ppm, as shown in Figure 5. This is somewhat higher than normal atmospheric air, which is less than 300 ppm. This higher than usual level occurred because the URL ventilation air is heated with "in-stream" propane heaters located in the fresh-air intake at the surface. The carbon dioxide combustion product is mixed with the incoming air.

The carbon dioxide concentration outside the station just before the volunteers entered the station was slightly higher, likely because there were many people active in the area to assist with the preparations for the test.

The carbon dioxide concentrations outside the refuge station showed a minimum around 1800 on March 04 at the start of the test, and a steady rise to a maximum near 0800 the next morning, corresponding inversely with surface daily maximum and minimum temperatures. This was because of the thermostat setup on the surface propane heaters, which will increase the heater output as the outside temperature decreases.

A sharp peak outside the station approximately 15.5 h into the test is attributed to someone leaning over the Comfocheck instrument at that moment to examine it.

4.3 Relative Humidity

Figure 6 show the relative humidity outside the station. The outside humidity varied between 70% and 80%. This is normal for the URL underground atmosphere during the winter months when the propane heaters are in use. The combustion products of propane are carbon dioxide and water vapour.

The relative humidity measured by the two Comfocheck units inside the simulated refuge station is shown in Figures 7 and 8. Both units indicated that the relative humidity increased rapidly within the first hour of the test to a maximum value. The Comfocheck was not calibrated to 100% humidity and in fact the RH sensor is only guaranteed to a 90% calibration level. Values above 90% can only be interpreted as tracking humidity changes in a qualitative way. Since the volunteers exhaled considerable amounts of water vapour, it may be expected that the actual relative humidity was approximately 100%.

The Comfocheck unit located on the shelf beside the window was positioned with its sensor within 30 to 50 mm of the rock surface, which was cooler than the air. As the scrubber also removes water from the air to a limited degree, one would expect the unit located on top of the RANA-AIR unit would show somewhat lower values, as it did.

The humidity, as described by the volunteer participants, became very apparent a few hours into the test. Clothing that was taken

COMFOCHECK LOG-TUNNEL CARBON DIOXIDE TOMMYKNOCKER TEST 1993, MARCH 4-5

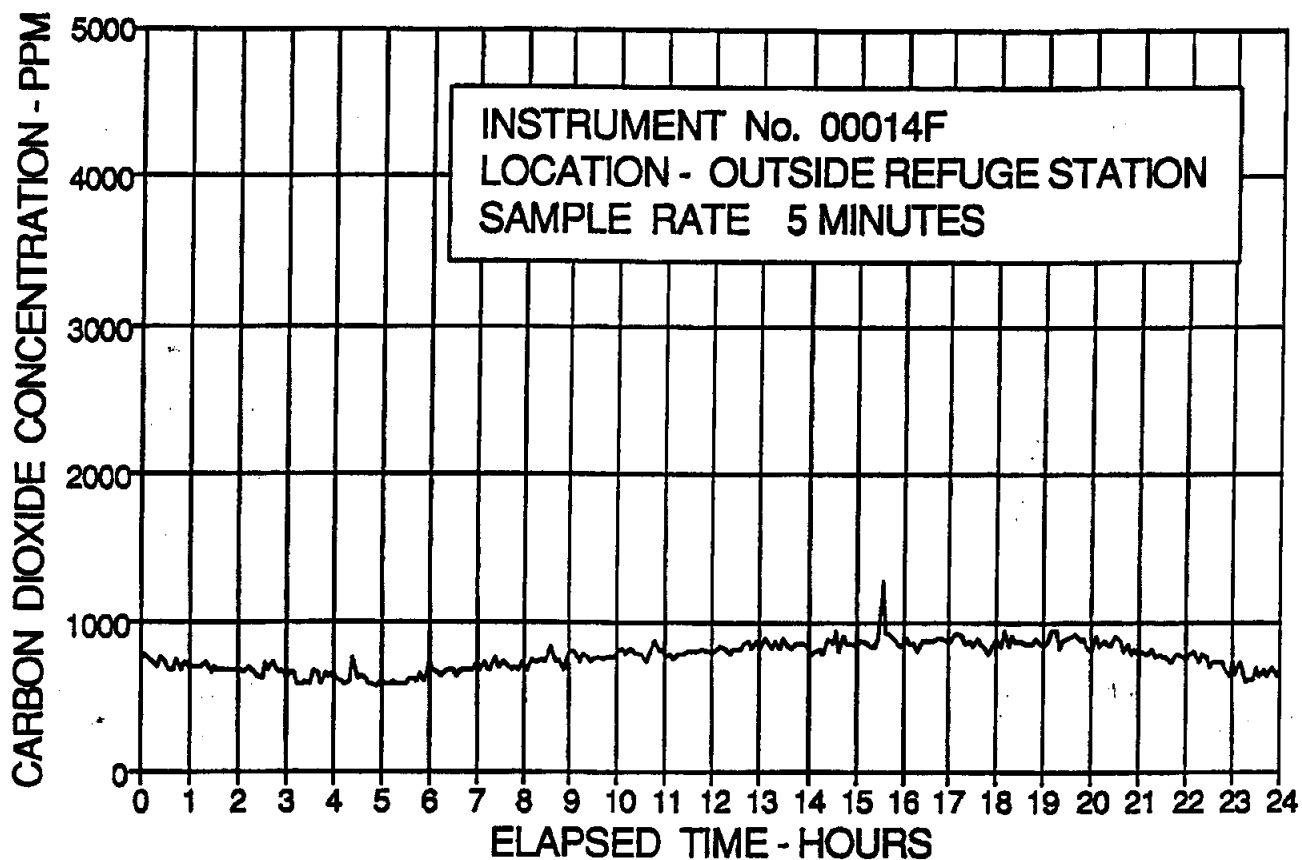
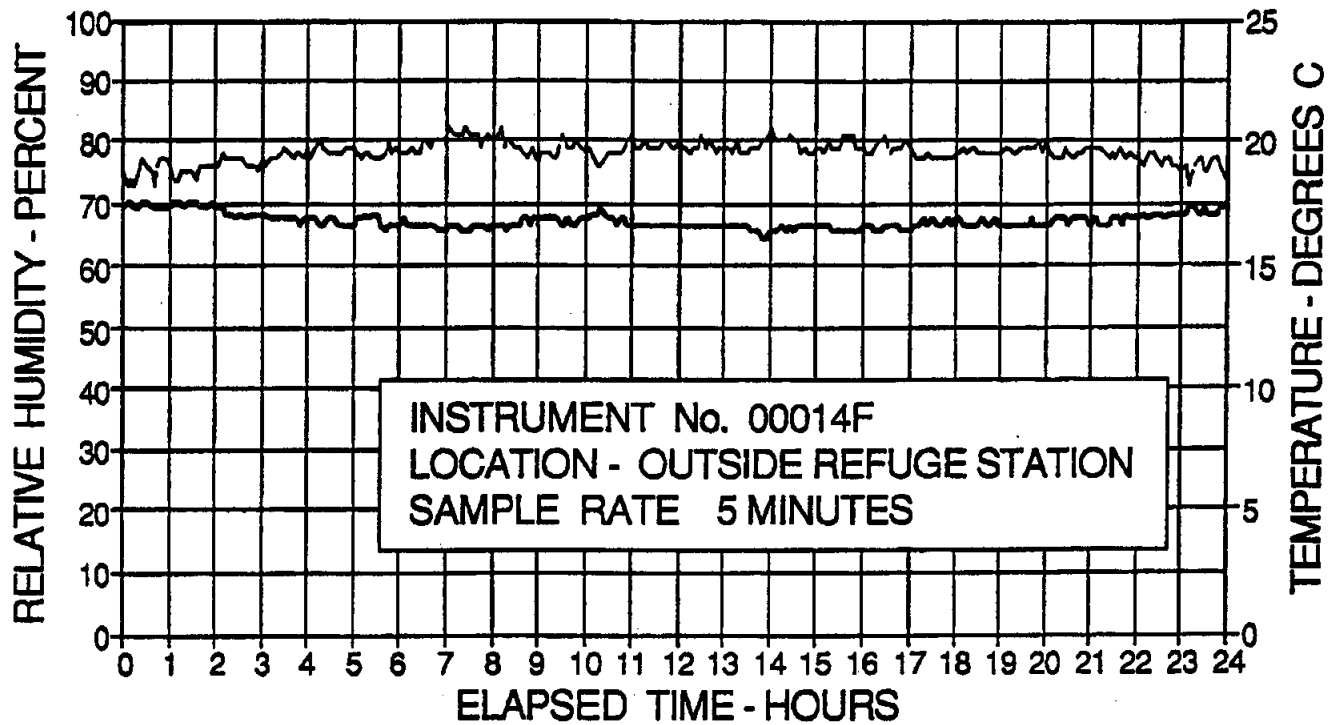

Figure 5

COMFOCHECK LOG-TUNNEL RH & TEMPERATURE TOMMYKNOCKER TEST 1993, MARCH 4-5



---- RELATIVE HUMIDITY — TEMPERATURE

Figure 6

COMFOCHECK LOG HUMIDITY & TEMPERATURE TOMMYKNOCKER TEST 1993, MARCH 4-5

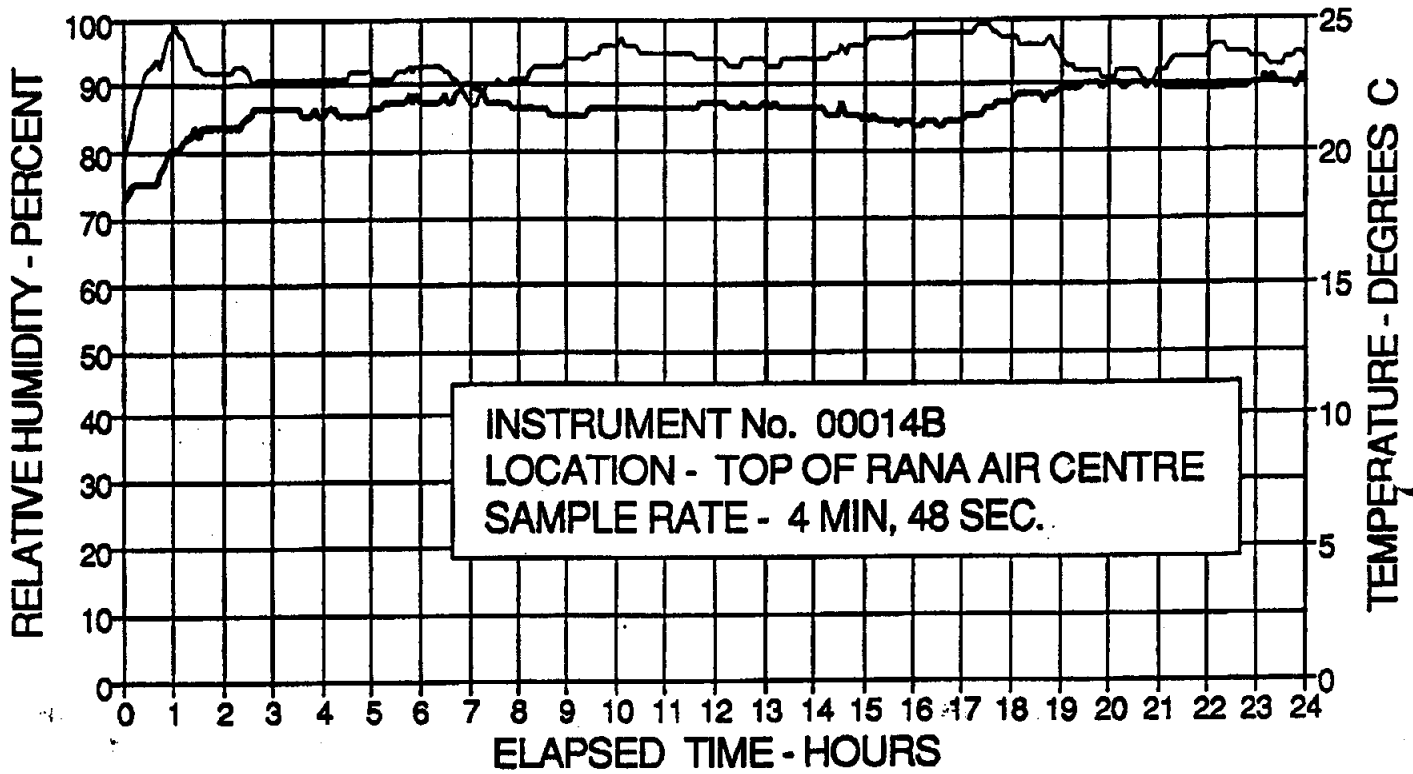

Figure 7

COMFOCHECK LOG HUMIDITY & TEMPERATURE TOMMYKNOCKER TEST 1993, MARCH 4-5

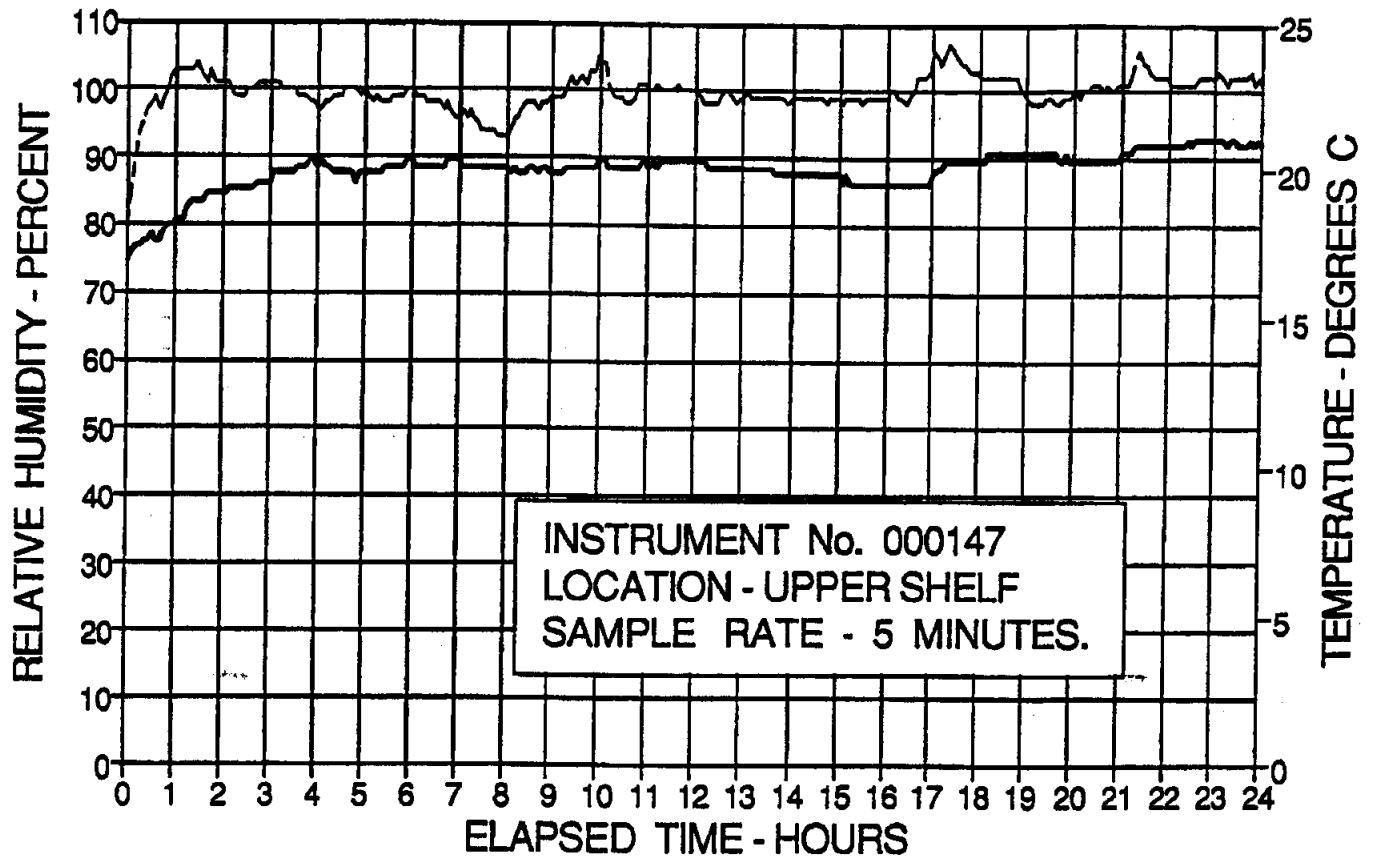

Figure 8

off and placed on the benches became damp and felt very clammy when put back on. The sandwiches became "soggy" if not kept within closed containers. The back of the station became moist, but not enough water was present for droplets to form and fall.

The sling psychrometer used by the volunteers inside the refuge station produced totally variable readings because the humidity was so high. The sling psychrometer used outside the refuge station was quite reliable in the 70-80% RH range.

4.4 Temperature

The outside temperature is shown in Figure 6. It varied between 16.5 and 18.5°C. Temperatures were lower during the evening and night hours because of decrease in surface air temperature.

Temperatures measured by the two Comfocheck units located inside the simulated refuge station are shown in Figures 7 and 8. The temperatures recorded by both units are essentially identical, with no unusual features. Figure 9 shows that the temperature inside the room climbed from about 16°C at the beginning of the test to about 20°C after about 3 h, while the outside temperature remained fairly steady around 15°C.

Figure 10 shows the temperatures measured by the thermistors located at the back, wall and floor inside the simulated refuge station. The temperatures measured by the thermistors located above the floor level were similar to those determined by the two Comfocheck units. The temperature at the floor level was 2°C lower throughout the test.

Thermistors were placed on the air inlet and outlet of the RANA-AIR system. The data collected are shown in Figure 11. As would be expected, once the carbon dioxide absorber had stabilized, the air coming out of the system was at a somewhat higher temperature than the ambient air because of the chemical action of the carbon-dioxide-adsorbing material. The outlet air temperature stabilized at about 24°C, whereas the inlet air temperature was similar to that measured by the other thermistors inside the station, 20°C. The outlet temperature tracks the inlet temperature. This indicates that the carbon dioxide absorber did not have a significant effect on the temperature in the refuge station.

Figure 9 shows a plot of the air temperatures measured by the thermistors inside and outside the room. The thermistor located outside the room indicated a temperature of 15°C. This is about 1-2°C lower than the temperature indicated by the Comfocheck unit located outside the station (Figure 6). This difference is most likely attributable to the different measurement positions. The thermistor was located underneath a table, exposed to the cool floor, while the Comfocheck instrument was located on top of an adjoining table and was better exposed to the circulating air.

TOMMYKNOCKER AIR TEMPERATURE RECORD 1993, MARCH 4-5

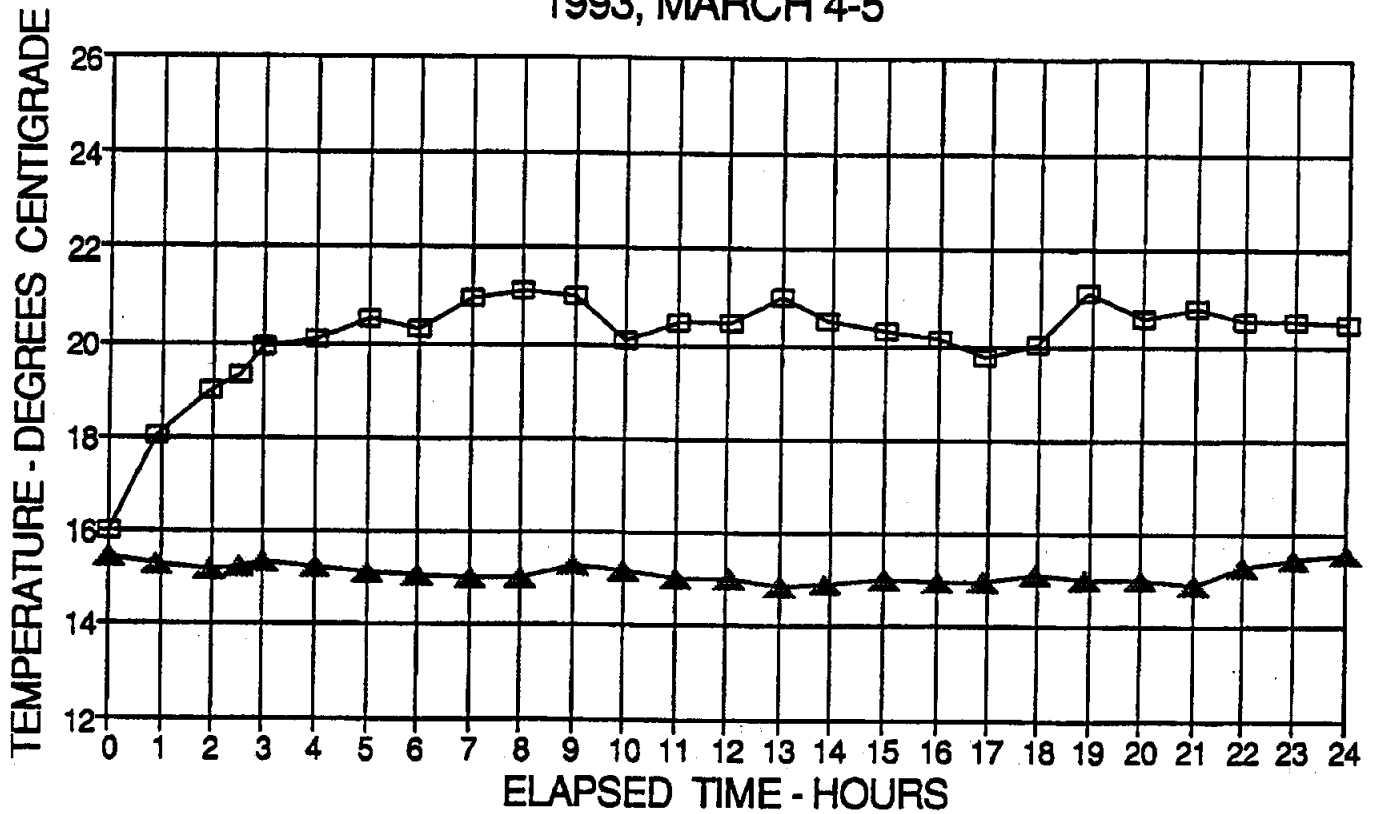

—□— IN REFUGE CENTRE —▲— OUTSIDE AMBIENT

Figure 9

TOMMYKNOCKER ROOM TEMPERATURE RECORD 1993, MARCH 4-5

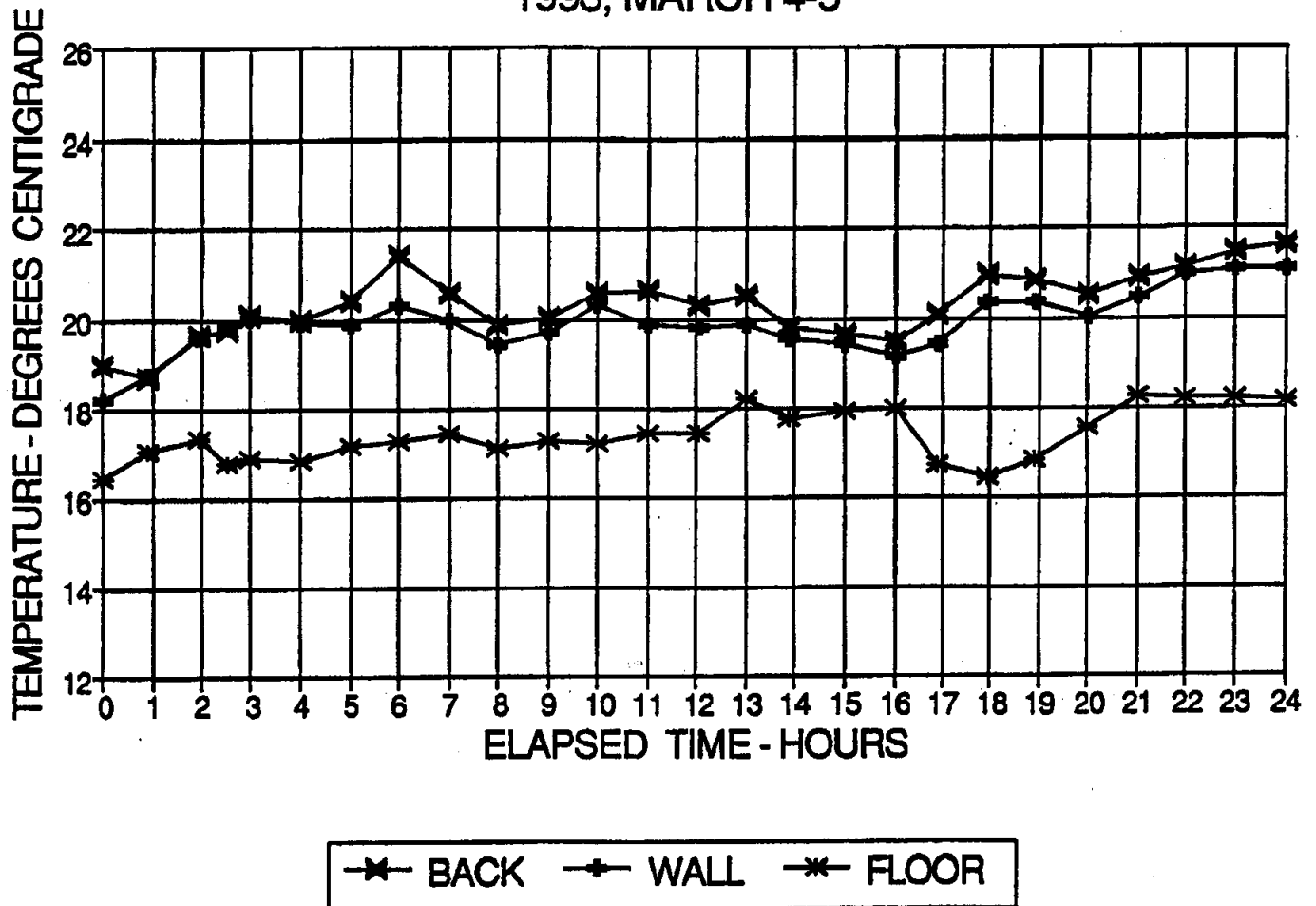

Figure 10

RANA-AIR CENTRE AIR TEMPERATURES TOMMYKNOCKER TEST 1993, MARCH 4-5

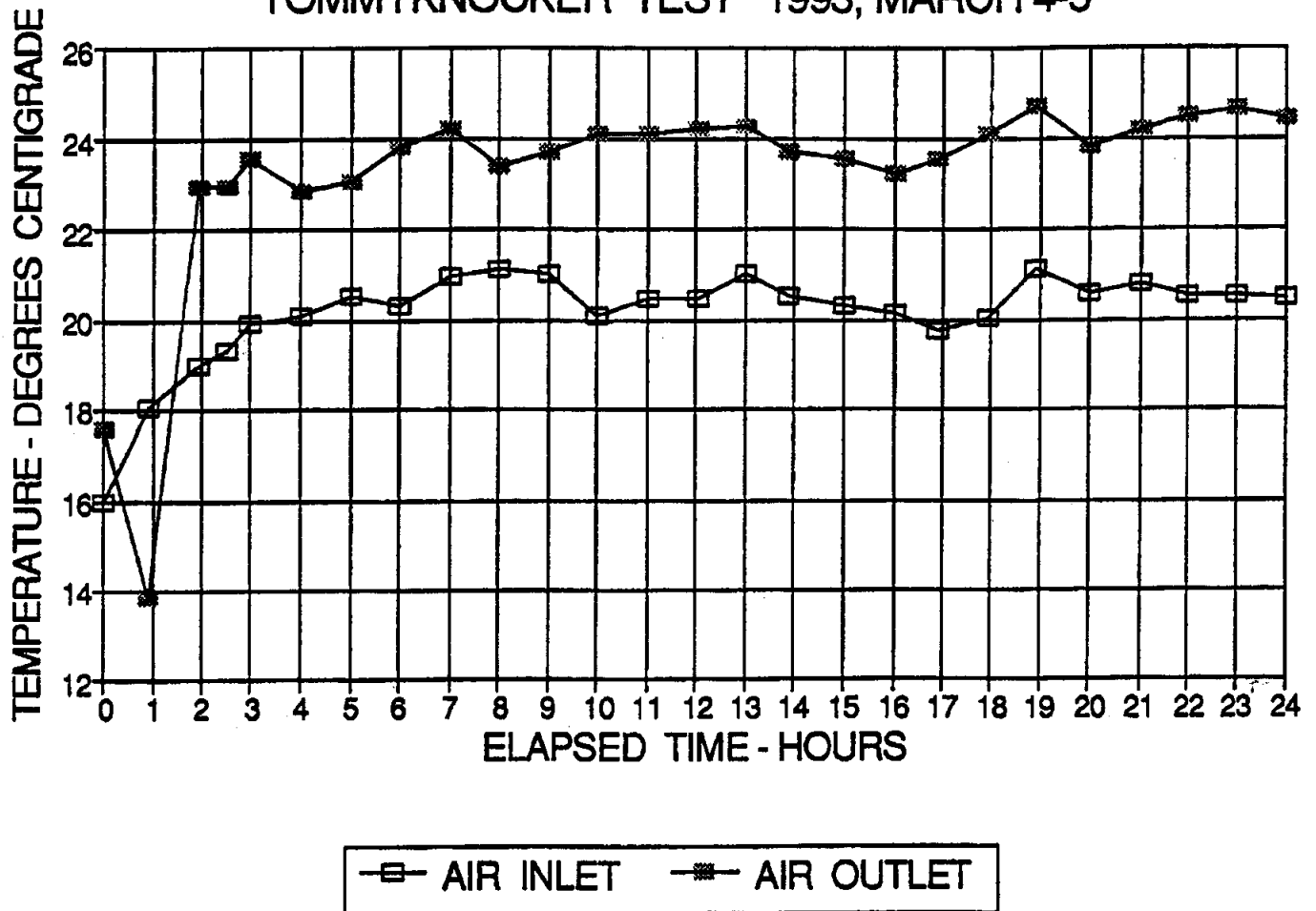

Figure 11

4.5 Barometric Pressure

There was no significant change in the barometric pressure measured with a mercury barometer on the 240-m level during the test. The pressures recorded were in the 758 mm Hg range, +/- 4 mm. The manometer installed through the window of the station showed no relative difference in pressure inside and outside of the room, except for a brief period at the end of the test. During the last few minutes of the test, the volunteer participants were asked to increase the oxygen flow to produce a slight pressure increase. The manometer registered an increase of 24.6 mm of water inside the room, which took 36 s to equalize. This suggests that the simulated refuge station was effectively sealed during the test.

4.6 Performance of the RANA-AIR System

The volunteer participants recorded their opinions on performance and ease of use of the RANA-AIR system. These comments are presented in Appendix B, Participant Comments and Evaluation. Briefly, they thought the system was simple and easy to use. The measurements of carbon dioxide and oxygen levels indicate that the system maintained safe levels successfully.

4.7 Medical Surveillance

During the morning of March 04, Dr. R. Hawkins, Medical Director, AECL Research, examined eight volunteers and declared six men to be fit for 24-h confinement in the simulated refuge station.

At 1300 on March 05 the men were re-examined by Dr. T. D. Redekop, Chief Occupational Medical Officer, Manitoba Ministry of Labour, after completion the Operation Tommyknocker. All six men were asymptomatic and had no complaints about their reaction to the 24-h confinement, except that they had all experienced mild headaches early on before the oxygen-generating equipment was functioning and the carbon dioxide level in the room exceeded 5000 ppm for a brief duration. Their headaches subsided relatively quickly as the carbon dioxide level dropped to an acceptable level.

The men monitored their own blood pressure during this time period. The results did not indicate any level of concern.

Either Dr. Redekop or Dr. Hawkins was present to monitor the participants from outside the simulated refuge station during the 24-h test period.

The oxygen level in the refuge station was maintained at around 20.5% while the carbon dioxide level fluctuated around 2000 ppm. This level of carbon dioxide, well above the ambient air level, was quite acceptable for such circumstances, and in general one would not expect people to have any symptoms. The temperature in the room remained stable at about 20°C. The relative humidity rose to nearly 100%, which was not surprising considering six adults

were confined in a small space. The volunteer participants did not complain about this to any extent. They did notice that they felt slightly chilly at night time when they were trying to sleep, even though the temperature remained at about 20°C.

A letter from Dr. T. D. Redekop, dated 1993 March 9, provided a medical opinion on the status of the volunteers participants and the levels of carbon dioxide and oxygen maintained during the test. To summarize, the gas concentrations were kept well within safe limits and the volunteers were healthy and unaffected by the test.

4.8 Feedback from the Participants

The volunteer participants generally felt comfortable during the test. There were no offensive odours from the RANA-AIR system or other conditions that threatened the disruption of the test. The participants were able to sleep during most of the late night hours. Appendix B contains a letter from R. Sullivan, volunteer participant from Hudson Bay Mining and Smelting, which is a summary of his views.

The volunteer participants indicated that the location of the toilet within the door lock area was in fact very important. It likely would not have been possible to continue the test if this provision had not been made. This fact is very relevant to the design of actual underground refuge stations. Provisions should be made for toilet facilities separated from the rest of the space.

4.9 Debriefing Notes

A debriefing was carried out after the test. The following points were noted during the debriefing.

1. It was suggested that the RANA-AIR system could be made smaller.
2. A Plexiglas cover could be placed over the gauges for better mechanical protection.
3. The battery charge alarm light came on shortly after the start of the test. The volunteer participants were somewhat confused by this until they read the manual. Some instruction concerning the light could be written on the panel.
4. The oxygen levels were less than normal, 20.9%. The volunteer participants said they had no great urge to increase the oxygen level delivery rate on the basis of this. There was a strong tendency to go along with the way they felt. Once their headaches went away after the RANA-AIR system was started, they felt happy to leave the oxygen settings alone.

5. There were some problems with the oxygen gas detection tubes. They were not working towards the end of the test. Oxygen readings over 26% were being obtained, which did not agree with the Kanomax unit within the station.
6. The Kanomax oxygen analyzer worked well during the test, however, the batteries went dead about 1930, and the unit was useless after this time. It was believed that this length of battery operation is typical for this type of self-contained unit.
7. It was suggested that the classical symptoms of carbon dioxide poisoning and oxygen deficiency be included in the manual. In the event of failure of gas detection tubes or gas analyzers, one could use these symptoms as a means of monitoring the carbon dioxide and possibly the oxygen levels within a refuge station.
8. A hand-operated blower could be considered as a standby unit for the electric fan.
9. The colour change of the carbon dioxide level was apparent after 18 h of operation. The colour change is intended to be a pre-warning only. It is reliable but not accurate. It was intended that the absorbing material would be changed on the basis of carbon dioxide levels determined by the gas detection tubes.
10. The noise made by the RANA-AIR system did not bother the volunteer participants.
11. The level of carbon dioxide in the simulated refuge station varied with the level of activity of the volunteer participants. The levels were lowest when the activity was low.
12. There were no unusual odours noticed. The unit blew cool air all the time.
13. The humidity was acceptable. It tended to get somewhat cool in the simulated refuge station. Water constantly dripped off the walls, but not the back of the unit.
14. The toilet would have been unbearable if kept in the same room. The toilet had an ammonia smell at the beginning, and a refuse smell later on.
15. The difference in temperature of up to 6°C between top and bottom of the simulated refuge station was noticeable.
16. The participants felt that the design of the RANA-AIR system was simple enough and easy to use. The unit should be reliable and easy to repair.

17. It was generally felt that the Manitoba code for refuge stations could incorporate some of the information gathered by the test. Such things as considerations for separated toilet facilities and air locks could be considered.
18. It would be most beneficial if the RANA-AIR system incorporated a means of removing noxious gases and smoke from an underground refuge station as well. The station may be contaminated with gases such as carbon dioxide, nitrous oxides and smoke that may be present as a result of a fire.
19. A flame safety lamp could possibly be used to test for oxygen levels. This may not be a good idea when oxygen under pressure is used.

5. CONCLUSIONS

Operation Tommyknocker demonstrated that the RANA-AIR system was "simple and easy" to use. The volunteer participants operated the system for a full 24-h period with a minimum amount of instruction. The operating manual was acceptable and sufficient to operate the equipment.

It was clearly demonstrated that the RANA-AIR system maintained oxygen and carbon dioxide levels to safe values within the sealed, simulated refuge station for the duration of the test. Activity and delay in turning on the RANA-AIR system produced a high carbon dioxide level of 8000 ppm. Consequently, the carbon dioxide levels rose to levels above 0.5% for a short period. The volunteer participants experienced typical minor headaches as a result of this. This indicates that immediate control of the carbon dioxide levels is very important in underground refuge stations once they become isolated.

The monitoring system, which consisted of gas detection tubes for determining the levels of oxygen and carbon dioxide, was tested. The equipment was appropriate given the experience and anxiety level of those required to use it. The gas detection tubes for determining the carbon dioxide levels were effective. However, the gas detection tubes for measuring oxygen were unreliable, giving erroneous readings. Another method should be used to determine the oxygen levels if monitoring is required.

6. RECOMMENDATIONS

1. The RANA-AIR system should be developed for use in underground refuge stations.
2. A method other than gas detection tubes should be used to determine the levels of oxygen for monitoring the atmospheric conditions within the refuge station.
3. A system to remove noxious gases that may be present as a result of a fire underground should be incorporated within the design of the RANA-AIR system.

ACKNOWLEDGMENT

The authors wish to thank the Manitoba Department of Labour, the Mine Accident Prevention Association of Manitoba, AECL Research, INCO Thompson, Hudson Bay Mining and Smelting, Tantalum Mining Corporation of Canada, Croda Canada Ltd., Molecular Products Ltd., and the volunteer participants who kindly dedicated their time and effort to ensure Operation Tommyknocker was planned and carried out to achieve the objectives and goals. Through the efforts of these organizations, companies and individuals, we believe the RANA-AIR Mine Refuge Air Centre, being developed by Rimer Alco North America Limited to improve safety in underground mining and civil operations, is a great step closer to being a marketable commodity.

REFERENCES

1. Labour Canada Occupational Safety and Health Code.
2. Threshold Limit Values for Chemical Substances and Physical Agents, 1992-1993. American Conference of Governmental Industrial Hygienists, Cincinnati, OH.
3. U.C.Luft, Aerospace Environments, Chapter 10 of Environmental Physiology, N.B. Slonim, Editor, C.V. Mosby Co., 1974.

APPENDIX A

List of Participants

OPERATION TOMMYKNOCKER

List of Participants

Organizers

Greg Kuzyk	Engineer, AECL Research, Underground Research Laboratory
Earl Gardiner	President, Rimer Alco North America
Barrie Simoneau	Safety Coordinator, Mines Accident Prevention Association of Manitoba
Ray Lambert	AECL Research, Radiation and Industrial Safety
Ron Glassford	Director, Mines Inspection, Workplace Environment, Safety and Health, Manitoba Department of Labour
Bill Schubert	Mine Rescue Instructor, Workplace Environment, Safety and Health, Manitoba Department of Labour
Dr. Ray Hawkins	AECL Research, Medical Services Branch
Dr. Ted Redekop	Chief Occupational Medical Officer, Workplace Safety, Health and Support Services Division, Manitoba Department of Labour

Test Participants

Vern Steiner	AECL Research, Underground Research Laboratory
Ed Chuckrey	INCO Thompson
Ron Sullivan	Hudson Bay Mining and Smelting
Tim Haverlock	Tanco
Don Daymond	AECL Research, Underground Research Laboratory
Jamie Law	Tanco
Dennis Wilson	Hudson Bay Mining and Smelting
Wayne Mattson	INCO Thompson

Supporting Staff

Barney Kovacs	Manitoba Mining Association
Monte Raber	Rimer Alco North America
Gary Wallace	AECL Research
Paul Barnsdale	AECL Research
Don Hladki	AECL Research
Andy Gerwing	AECL Research
Jane Sargent	AECL Research
André Salloum	AECL Research
Larry Shewchuk	AECL Research
Rich Corman	AECL Research
Mitch Ohta	AECL Research, Underground Research Laboratory
Harry Backer	AECL Research, Underground Research Laboratory
Dwayne Onagi	AECL Research, Underground Research Laboratory
Glen Karklin	AECL Research, Underground Research Laboratory
Walter Schmidt	AECL Research, Underground Research Laboratory
Glen Snider	AECL Research
Richard Simcoe	J.S. Redpath Limited
Rolly Simard	Tanco
Ron Casson	Manitoba Department of Labour

Visitors

Darren Praznik	Minister of Labour and MLA Lac du Bonnet
Ben Sveinsen	MLA La Verendrye
Dave Marion	Reeve, RM of Lac du Bonnet
Robert Vachon	RCMP, Lac du Bonnet
Gille Lafreniere	RCMP, Lac du Bonnet
Nick Ostash	Bond Gold

APPENDIX B

Technical Information

Participant Comments and Evaluation

Letter from Dr. T.D. Redekop

Letter from R. Sullivan

RIMER ALCO NORTH AMERICA**MINE REFUGE AIR CENTRE TESTS****'PARTICIPANT COMMENTS AND EVALUATION'**

Determine how "simple and easy" it is to use.

- . Fairly straight forward.
- . Very simple and easy. Directions on the system are very self-explanatory. It may be difficult for some non-mine rescue people to understand.
- . Very simple and easy. RANA-AIR could be used by anyone without any prior knowledge of the system.
- . Very simple. Instructions on the unit itself are clear and concise. I would venture to say, even an engineer could operate this equipment. (Maybe this is a rash statement.)
- . The machine was easy to fill and simple to start according to the directions.
- . Easy to start and easy to refill. Door should be removed, or replaced with a screen.

Prove it's ability to maintain Oxygen and Carbon Dioxide levels as close to atmospheric as possible.

- . So far it has done a very good job.
- . It has done its job, 20 minutes after it was turned on our headaches were gone.
- . Our records will show unit works perfectly without any adjustments.
- . CO₂ levels were increasing as we started the test. (There was a lot of pre-test action in the refuge station and a number of people in the room.) Within half an hour, the O₂ and CO₂ levels were within acceptable values.
- . According to our records, the machine works very good. We had no problems with the levels once it was started.
- . CO₂ levels were up. After starting up RANA-AIR, CO₂ dropped down.

Determine if the monitoring equipment provided with the system (to measure concentrations of O₂ and CO₂) are effective and appropriate, given the experience, training and anxiety of those required to operate it.

- Definite problems with O₂ tubes. Need to make sure expiry dates are current. Expiry 1992 tubes for CO₂ were not very good. 1992 CO₂ were N=1 while 1995 tubes were N=1+5. Need barometric pressure gauge and chart of O₂ barometric readings for quick and easy O₂ conversions.
- Bulb works well.
- We are familiar with Draeger tubes, but non-mine rescue people should have better instructions. Equipment supplied with the RANA-AIR would not be complete without a barometer. This should be built into the machine so the value can be seen.
- CO₂ tubes work effectively. O₂ tubes can only be used once when the humidity gets high. Without a barometric pressure, the O₂ value cannot be calculated. A barometer on the RANA-AIR system would be a definite requirement. A graph of barometric pressure versus tube readings would eliminate calculations.
- The equipment supplied was sufficient and easy to use, but non-mine rescue personnel might need better instructions.
- Problems with O₂ tubes (3 tests to tube at beginning). Towards the end of the test, O₂ tubes were not reading accurately. Some readings as high as 23%

Size, Colour and Shape of System:

- Size seems bulky; appears to be a lot of wasted inside space. Possibility of having external O₂ bottles?
- Size seems a bit large, lots of wasted space where O₂ bottles are. By reducing size, the unit would be more portable.
- Bottom storage compartment door should be made to be removed. In our situation, it takes up floor space being open. We removed door. O₂ cylinders should be easier to put into the unit. Cylinders should go in from the side, not top.
- Colour OK. Shape OK. Size could be reduced by half if the O₂ bottles were external. Could then be cascaded with more O₂. A screen in the front door would negate having to open the front door.

- Size & Shape: The unit could be smaller. Colour: This has no bearing other than making instruction stand out more.
- Size could be reduced by half. Colour OK. Shape of system OK.

Noise Level:

- Not too bad, at least for me. Others find it irritating now especially after sleeping. Possibility of putting some type of muffler on to reduce the noise level some.
- The noise level is tolerable, even when sleeping.
- Low. Tolerate very easy.
- Tolerable. Can be aggravating in a small area when right next to system.
- There is no problem with the noise. If anything, it helps me sleep.
- OK if in a bigger Refuge Station.

Labelling and Manuals:

- Labelling is clear and easy to read. Should have "No Smoking" sign. O₂ instructions should be in RED.
- Small point: "Replace soda lime when colour change (purple) rises to arrows." There are no arrows. You should say "dashed line".
- O₂ warning should be in red. Manual is self explanatory. "No Smoking" signs should be on the system. Because of possible illiteracy on the part of someone who would use this system, a set of pictorial instructions in the manual might be useful.
- The labelling could stand out more. Example: Black letters on white. Manual should be simpler for non mine rescue users.
- O₂ warning should be in red.

Actual potential of Mining Companies to install these units in underground refuges:

- Good, especially if units could be made portable so that they could be used in temporary refuge locations (transported easily).

I would say the potential for underground use is quite good, taking into consideration cost, portability and durability.

My vote "YES".

This system would be very adaptable in a permanent refuge station or portable refuge station if the size were reduced.

I think personally, the system would work excellent in a refuge. Other than the size, it would be perfect for a mine refuge.

Yes, this system would be good to have in a refuge station.

Other:

- Should come with monitoring equipment (O₂, CO, RH).
- Storage door should be of screen.
- Should also have a side door for removing O₂ bottles, or make the unit smaller by having the bottles stand outside.
- O₂ & Litre Flow Indicator should be protected by some sort of see-through cover.
- Test start - Unit is producing cool air from exhaust.
- Test middle - above.
- Gloves could possibly be supplied in unit.
- Difficult to see colour change in soda lime. 6 a.m. - 0.5 cm first time really visible.
- Gauges should be protected.



Labour

Workplace Safety, Health
and Support Services Division

1000 — 330 St. Mary Avenue
Winnipeg, Manitoba, CANADA
R3C 3Z5

March 9, 1993

(204) 945-3446

Mr. Barrie D. Simoneau CRSP
Mines Accident Prevention
Association of Manitoba
700-305 Broadway Avenue
Winnipeg, Manitoba
R3C 3J7

Dear Mr. Simoneau:

RE: OPERATION TOMMYKNOCK MEDICAL REPORT

Number of Men Examined = 8

Number of Men Declared Fit for the 24 hour confinement in the mine refuge station = 6

Examiner Dr. R. Hawkins, AECL Medical Director (2 people were rejected for medical reasons - these 2 individuals supplied monitoring activity throughout this demonstration project).

Average age of participants was 37 years old; male - age ranged from 29 to 44.

All men were examined for fitness prior to entering the room. They were re-examined by me at 1:00 p.m. on March 5, 1993. All were asymptomatic and had no complaints about their reaction to the 24 hour confinement, except that they had all experienced mild headaches early on before the oxygenator was functioning and when the carbon dioxide level in the room reached at least 5000 ppm. Their headaches subsided relatively quickly as the carbon dioxide level dropped to an acceptable level.

The men monitored their own blood pressure during this time period, the results did not indicate any level of concern.

The oxygen level in the refuge station was maintained at around 20.5% while the carbon dioxide level fluctuated around 2000 ppm level. This level of carbon dioxide, well above the ambient air level, is quite acceptable for such circumstances and in general one would not expect people to have any symptoms. The temperature in the room remained stable at around 20°C. The relative humidity rose to near 100 % which is not surprising considering 6 adults in a small confined space but the participants did not complain about this to any extent. They did notice that they felt slightly chilly at night time when they were trying to sleep even though the temperature remained at about 20°C.

....2

MAR 15 1993

SUMMARY:

The six participants did not experience any adverse health effects except at start up when the carbon dioxide level rose to about 5000 ppm and prior to the oxygenator function.

Sincerely,



Dr. T. D. Redekop
Chief Occupational Medical Officer

PS: I think this was a very well run demonstration with optimum cooperation from the many participants. You are to be congratulated on organizing this so professionally.

Dr. Hawkins should be commended for steering the project through the ethics committee hurdle. This created some last minute "angst" but it did not impact on the timing nor the smooth running of this project.

cc: Dr. R. Hawkins, AECL
Ron Glassford

TDR/AR

COMMON-Z:TOMMYKNOCKER

**Hudson Bay Mining & Smelting Co., Ltd.
Ruttan Operations**

OPERATION TOMMYKNOCKER

Submitted by Ron Sullivan

Six men entered the Refuge Station at 1:00 pm, March 04, 1993.

After being in the station for approximately one half hour, the CO₂ went up to over 5000 ppm. All individuals started to get a headache.

At this time we started up the Rana-air unit, filling it with approximately 60 lbs. of soda lime. We then turned on the two oxygen bottles and set the oxygen flow to three litres per hour.

After the Rana-air unit was started, the CO₂ went back to normal.

All individuals in the station helped with the testing. We had to test for O₂, CO₂, temperature and "R" humidity. We also had our vital signs taken every hour for the first eight to ten hours, and during the last two hours we were in the Refuge Station.

The oxygen stayed at approximately 20.5% and the temperature was constant at 20.5° to 22.9° at the end of the twenty-four hour period. The "R" humidity levels were 80° to 90°, towards the end of the twenty-four hour period, it went up to over 100°.

There were photographs and videos taken during our confinement in the Refuge Station.

In conclusion, the Rana-air unit will provide the oxygen needed for breathing, and will remove the carbon dioxide produced by the miners during a period of entrapment.

Ron Sullivan
Advanced Mine Rescue
Ruttan Mine
March 16, 1993
/cs

**Operation Tommyknocker, Phase II - Evaluation of the
Rimer Alco, RANA-AIR Mine Refuge System at
Falconbridge Ltd., Kidd Creek Division.**

Michel Grenier*, John Vergunst+, Malcolm Smith,
Kevin Butler++, Stephen Hardcastle* and Barrie Simoneau"**

Division Report MRL 94-051 (TR) OCTOBER 1994

- * Research Scientist, Natural Resources Canada,
CANMET, Mining Research Laboratories,
Sudbury, Ontario, P3E 5P5, Tel : (705) 677-7815**
- + Provincial Mining Specialist - Environment,
Ontario Ministry of Labour, Sudbury, Ontario,
P3E 6B5**
- ** Senior Mine Rescue Officer, Ontario Ministry of
Labour, Sudbury, Ontario, P3E 6B5**
- ++ Mining Environment Technologist, Natural
Resources Canada, CANMET, Mining Research
Laboratories, Sudbury, Ontario, P3E 5P5**
- " Safety Director, Mines Accident Prevention
Association of Manitoba (MAPAM), Winnipeg,
Manitoba, R3C 3J7**



**FALCONBRIDGE
LIMITED**



**Royal Oak
Mines Inc.**



PLACER DOME INC.



**Ontario
Ministry of
Labour**



CANMET



MAPAM

TABLE OF CONTENTS

ABSTRACT	1
EXECUTIVE SUMMARY	2
BACKGROUND	4
RANA-AIR UNIT DESCRIPTION	5
SITE DESCRIPTION	8
INSTRUMENTATION	8
Sampling Strategy	8
Carbon Dioxide Monitoring	12
Oxygen Monitoring	12
Temperature, Relative Humidity and Pressure Monitoring	13
Vital Signs Monitoring	13
TEST PREPARATION	13
Medical Ethics Considerations	13
Volunteer Selection	14
Site Preparation	14
Leakage Testing of the Refuge Station Bulkhead	14
Equipment Testing	16
TEST DESCRIPTION AND SCHEDULE	16
RESULTS	16
Chamber Conditions	16
Carbon Dioxide, Oxygen, Rel. Humidity and Temperature at RANA-AIR Outlets	23
RANA-AIR Oxygen Flow Rate/Pressure and Color Change Indicator Observations	23
Vital Signs	29
Volunteers' Comments	29
DISCUSSIONS	30
CONCLUSIONS	33
RECOMMENDATION	34
ACKNOWLEDGMENTS	35
REFERENCES	35
APPENDIX I	37
APPENDIX II	39

LIST OF FIGURES

Figure 1. RANA-AIR system	7
Figure 2. Refuge station schematic plan	9
Figure 3. Schematic diagram of the refuge station bulkhead	10
Figure 4. Schematic diagram of manifold assembly	11
Figure 5. Differential pressure across refuge station bulkhead	18
Figure 6. Carbon dioxide concentration in the center of the refuge station	19
Figure 7. Carbon dioxide concentration in the refuge station	20
Figure 8. Oxygen concentration in the refuge station	21
Figure 9. Ambient temperature and relative humidity	22
Figure 10. Carbon dioxide concentration at the RANA-AIR outlets	24
Figure 11. Oxygen concentration at the RANA-AIR outlets	25
Figure 12. Relative humidity and temperature at the RANA-AIR outlets	26
Figure 13. Oxygen cylinder pressure	27
Figure 14. Theoretical and actual carbon dioxide concentration in the refuge station	31

LIST OF TABLES

Table 1. Average oxygen consumption and carbon dioxide production for humans	4
Table 2. Description of sampling locations inside the refuge station	12
Table 3. Results of the refuge station wall leakage/pressure test	15
Table 4. Scrubber material color indicator observations	28
Table 5. Average vital signs monitored on the 25 volunteers	29
Table A1. Average vital signs for the 25 volunteers	38

ABSTRACT

The Rimer Alco RANA-AIR prototype Mine Refuge System was tested in an underground refuge station to verify its ability to keep oxygen and carbon dioxide levels at normal or close to normal concentrations. In this test, 25 volunteers were assembled in a functional refuge station for a period of 24 hours, without the benefit of standard compressed air being supplied inside the sealed chamber. The prototype system was designed to operate on a self-contained power supply for a period of at least 27 hours. The system supplied oxygen at a metered rate and removed carbon dioxide by re-circulating the refuge station air through soda lime scrubbing units or drawers. Throughout the 24 hour period, carbon dioxide concentrations were maintained at an average of 2500 ppm and oxygen concentration remained in a narrow range between 20.2% and 20.6%. The volunteers inside the refuge station found the prototype easy to use and expressed confidence in its ability to provide a safe atmosphere. The test showed that this technology has the potential of becoming part of a refuge station's emergency equipment.

EXECUTIVE SUMMARY

In underground mines, standard emergency procedures require miners to take refuge in a safe area in the event of a mine fire. In these refuge stations, workers are required to seal themselves in and to turn on a compressed air line to supply air for breathing. There have been instances where the compressed air line has failed. Therefore, alternative means of supplying breathable air are being investigated.

In April of 1994, 25 Ontario Mine Rescue team members volunteered to spend 24 hours in a sealed underground refuge station on the 5200 Level at the Kidd Creek Mine (Falconbridge Ltd.). This project required the direct involvement of several mining companies and agencies, namely, Falconbridge Ltd., Kidd Creek Division, Placer Dome Inc., Dome Mine, Royal Oak Mines Inc., Timmins Division, Rimer Alco North America Inc., the Ontario Ministry of Labour - Ontario Mine Rescue, the Mines Accident Prevention Association of Manitoba and CANMET's Mining Research Laboratories. The test, which had previously undergone a medical ethics review, was conducted under strict medical guidelines. Volunteers were under the supervision of a physician throughout the test period via telephone and video camera contact.

The purpose of this study was to test the ability of the Rimer Alco North America RANA-AIR Mine Refuge System to provide the volunteers with breathable air during a 24 hour period and in the absence of compressed air. The unit is a stand alone system which supplies oxygen from cylinders and removes CO₂ by passing the refuge station air through chemical CO₂ scrubbing drawers.

One of the objectives of this study was to test the unit under realistic conditions. The unit was also evaluated from the point of view of ease of operation and user friendliness. The tests were designed to determine the unit's ability to provide a safe atmosphere and to verify that participants could, without outside help, effectively operate the system. This included deciding when the CO₂ chemical scrubbing drawers needed to be changed. The CO₂ chemical absorbent contains an indicator which turns blue or purple when the chemical is no longer effective. Oxygen and carbon dioxide concentrations inside the room were monitored remotely by CANMET staff with instrumentation located in the main drift.

Test results showed that the unit performed very well by successfully maintaining stable conditions. CO₂ increased from a baseline of about 700 ppm to stabilize at 2500 ppm. The time-weighted average exposure value (allowable limit of exposure) for an eight hour shift is 5000 ppm. In theory, this value of 5000 ppm would have been exceeded 1.5 hours into the test if neither compressed air or the RANA-AIR system had been available in the refuge station. Oxygen levels varied slightly between 20.2% and 20.6%. The initial concentration of oxygen in the refuge station was 20.6%. Normal atmospheric concentrations of oxygen are usually around 20.9%.

The participants also completed an extensive survey questionnaire, the results of which demonstrated a high level of acceptance for the system. Starting the unit, which includes filling the two scrubbing drawers with chemical took less than 10 minutes.

This study showed that one of two approaches can be used to determine when the CO₂ absorption chemical needs to be changed. First, the participants can decide to change the chemical when the color change indicator shows that half of the scrubbing chemical has been spent. Alternatively, a

theoretical approach can be used which assumes worst case conditions, and where a fixed amount of time is allowed to elapse after which the chemical is changed regardless of the state of the color indicator. Using the first approach, the volunteers would have changed the chemical scrubber ten hours into the study. The second approach would have required the participants to change the chemical every 6 to 7 hours with a significant safety margin. Data collected during the study showed that after 10 hours, both chemical drawers were still operating efficiently.

In summary, the field test conclusively showed that the life support system maintained oxygen and carbon dioxide concentrations well within safe levels. It also met and exceeded the original objectives of the test as well as the participants expectations.

BACKGROUND

Refuge stations became an integral part of the emergency procedures of Ontario mines, after 39 miners died in a mine fire in 1928. Typically, refuge stations are chambers which are excavated out of the rock close to where miners are working. These areas must be provided with drinking water, compressed air and a communication system. Refuge stations must also be separated from other workings by one or more fire walls.

The primary function of these refuge stations is to sustain life in the event of a major underground fire by preventing fire gases from entering and by providing a source of breathable air. The air is usually provided by a compressed air line which is opened from inside the refuge station. The air also serves to pressurize the refuge station, thereby preventing noxious gases from entering.

In the event of a mine fire, the workers enter the nearest refuge station, activate the compressed air line, close and seal the door with fire clay and remain calm and at rest. Periodically, someone is asked to walk around the chamber to mix the air. It is important that the miners rest and remain calm in order to conserve oxygen and to keep the carbon dioxide levels as low as possible as shown in Table 1.

Level of Physical Activity	Breathing Rate (L/min.)	Oxygen Consumed (L/min.)	Carbon Dioxide Production (L/min.)
Exhausting Effort	69	3.2	2.7
Strenuous Work/Sports	46	2.1	1.8
Moderate Exercise	30	1.4	1.2
Mild Exercise	19	0.9	0.7
Standing/Light Work	11	0.5	0.4
Sedentary/At Ease	7.5	0.4	0.3
Reclining/At Rest	6.0	0.3	0.2

Table 1. Average oxygen consumption and carbon dioxide production for humans (1).

Recently, emergencies have occurred in hard rock mines where compressed air lines supplying refuge stations have been damaged or destroyed. In one instance, smoke was transported through a ruptured air line, into a refuge station (Ontario, 1990). Some soft rock mines do not have compressed air underground and as more and more of the mine production is performed without compressed air, the need for self-contained life support systems for refuge stations becomes an important issue.

The Mines Accident Prevention Association of Manitoba (MAPAM) and the Manitoba Department of Labour in cooperation with the Ontario Ministry of Labour (Mine Rescue) decided that an initiative was necessary to determine what other types of protection could be made available in the event of a fire emergency. Through a collaborative effort involving the above parties and Rimer Alco North America, work began to develop a life support system for refuge stations. Rimer Alco is a Canadian Company (Morden, Manitoba) which manufactures on-site hospital oxygen production plants.

In March of 1993, six volunteers entered a simulated refuge station at the 240 m level of the Atomic Energy of Canada Ltd.'s Underground Research Laboratory at Lac Du Bonnet, Manitoba. The 22m³ chamber (777 ft³) was sealed and for the next 24 hours, the participants depended solely on the Rimer Alco North America Inc. RANA-AIR Mine Refuge Station System to maintain safe levels of oxygen and carbon dioxide. This first field trial was appropriately designated as Project Tommyknocker (legendary spirits of trapped coal miners).

This first evaluation demonstrated that under these simulated conditions, the RANA-AIR system successfully maintained oxygen concentrations between 19.5% and 20.9%, while keeping carbon dioxide levels at less than 2300 ppm. The report of investigation for this first phase (2) concluded that the RANA-AIR system was easy to use and could over an extended period of time maintain safe environmental conditions within the room. The report also stated that under actual emergency situations, trapped personnel would need a method other than CO₂ gas detection tubes for deciding whether or not the CO₂ scrubbing material used by the system needed to be changed.

In April of 1994, a second study was undertaken which is described in the present report. The objectives of Tommyknocker II were :

1. to evaluate the RANA-AIR system in a real underground refuge station containing a large number of mine rescue personnel,
2. to test an improved prototype of the system for ease of operation as per the first study recommendations and to verify the system's ability to maintain safe levels of CO₂ and O₂
3. to use external monitoring of gases in the refuge station in order to duplicate realistic conditions where personnel inside have to take the decision as to whether or not to change the CO₂ scrubbing drawers using only the scrubbing material indicator (color change).
4. and, finally, to determine the potential applications of this equipment in underground emergency situations.

In order to achieve these goals, twenty five mine rescue volunteers were selected and were asked to spend 24 hours in an operating Ontario mine refuge station. These volunteers were asked to follow normal fire emergency procedures upon entering the refuge station. This included choosing a leader and proceeding to sealing the outside door with fire clay. In addition a team was selected to prepare and start the RANA-AIR system. Throughout the test, the volunteers took turns at monitoring the life support system to insure proper operation. The volunteers' vital signs were monitored on an on-going basis as well as levels of CO₂ and O₂ in several locations inside the refuge station.

RANA-AIR UNIT DESCRIPTION

The RANA-AIR unit consists of two integrated processes; an oxygen supply and a carbon dioxide scrubbing system. The prototype tested was designed to accommodate 25 miners over a period of at least 24 hours. To supply oxygen, three cylinders were linked to a manifold and their pressure was regulated down to accurately set the required flow of 0.5 L/min. per person. This was achieved with a single stage regulator and a rotameter. Based on available research on human

oxygen consumption, the system was designed to supply the 25 volunteers for a period of at least 27 hours.

Carbon dioxide is removed by circulating refuge station air through two separate scrubbing drawers using battery operated fans, each operating at 2260 L/min. (80 cfm). The scrubbing chemical (Sofnolime), is a soda lime manufactured by Molecular Products UK. The principles of CO₂ scrubbing using soda lime involves a series of chemical reactions whereby the gas diffuses into the water layer surrounding the soda lime granules. The scrubbed air is then discharged on opposite sides of the console in order to enhance air circulation in the refuge station (See Figure 1). As the chemical becomes saturated with CO₂, it changes color from white to blue or purple. When the color change reaches a line near the top of an observation window, it is an indication that the chemical in the drawers should be replaced with fresh material.

The dimensions of the prototype system tested were 169 cm in height, 91 cm in depth and 65 cm in width (66 in. x 36 in. x 26 in.) and it weighed approximately 410 kg (900 lbs). Chemical scrubber capacities were 52 L and 41 L, respectively, for the side and front drawer. At 25°C and 80% relative humidity the front drawer should in theory last 6 to 7 hours while the side unit could last as long as 9 hours. Under the actual test conditions of 26°C and 95% relative humidity the drawers should last about 40% longer. To accommodate these conditions, enough chemical was stored in the refuge station to allow up to 5 complete drawer changes.

The long-life battery used to power the system, when fully charged, will provide for a minimum of 36 hours of operation. Built into the system is a charging circuit which automatically maintains full charge. This circuit also includes an alarm which will warn personnel if the power supply capacity falls below what is required to supply 24 hours of service. This is a useful feature in the event that the unit becomes unplugged or if the AC power supply is interrupted. During the test, the unit was unplugged to simulate a power disruption.

The system controls were designed to be simple to insure that untrained people could easily start and operate the system if required to. There are two main operating controls on the system, these are the oxygen flow regulator and the fan On/Off switch. Five basic instructions are clearly listed on the RANA-AIR unit's front panel. These are :

1. Remove CO₂ drawers and fill with soda lime. Re-insert drawers and tighten into place.
2. Slowly open oxygen tank valves in rear compartment.
3. Set O₂ flow control to the recommended setting for the number of people in the room.
4. Turn "ON" CO₂ blowers and open the lower storage compartment hatch.
5. Change soda lime as per directions on CO₂ absorber drawer.

IMPORTANT : refer to manual for detailed operating instructions.

The numbers 1 to 5 on the list above are also found clearly identified on the surface of the system casing near the part of the unit where the task needs to be performed.

Included with the system is an Operator's Manual, which describes the operation of the system as well as details on maintenance and service requirements. Also included with the unit are supplies such as dust masks, garbage bags, ear plugs and pens.

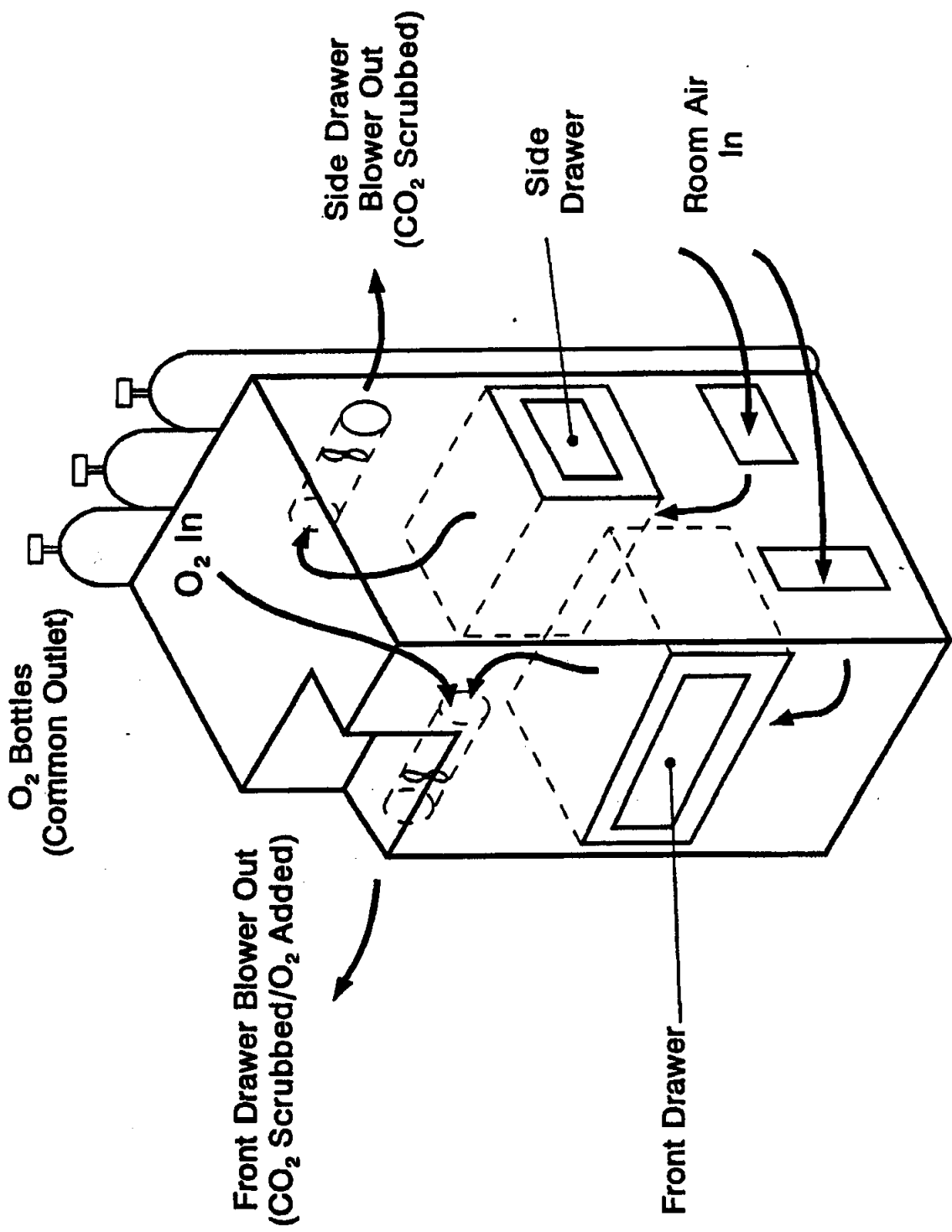

Figure 1. RANA-AIR system.

SITE DESCRIPTION

The mine refuge station chosen for the test was located on the 5200 level of Falconbridge Ltd., Kidd Creek mine. It was typical in size and design and could easily accommodate the 25 volunteers. It was constructed with an airlock and a two door entry system on both bulkheads (see Figure 2). The station dimensions were on average 12.4 m in length, 5.3 m in width and 3.6 m in height (40.7 ft. x 17.4 ft. x 11.8 ft.) for a total approximate volume of 240 m³ (8475 ft³). With 25 volunteers this meant an average of 9.6 m³ (339 ft³) volume of air per person as compared to 3.7 m³ (131 ft³) for the phase I test in Manitoba.

The refuge station was serviced with air and water. The air line was closed off in the main drift for the duration of the test. Both bulkheads were constructed of 25 cm (10 in.) thick poured concrete and these were sealed wherever the walls met the rock. Both walls have openings to allow services into the refuge station. These were covered with steel plates and sealed with foam insulation and fire resistant caulking (see Figure 3).

The airlock area was used to accommodate the chemical toilet. In the main chamber, an area close to the entrance and immediately to the left was used to store food and was also chosen to accommodate the vital signs monitoring area. The RANA-AIR system was installed on the left wall close to the center of the chamber. Five collapsible cots were placed at the end of the refuge station with the rest of the surface left available for tables and walking space.

An area immediately outside the refuge station was selected to accommodate the station for monitoring chamber conditions inside the chamber. The CO₂ and O₂ monitoring and calibration instruments were placed on a table in a well lit area on a level concrete pad. Electrical outlets supplied 120 VAC and a 3000 watt diesel generator was available for back-up electrical power. Flexible plastic tubing was run from internal sampling sites through the chamber bulkheads to the gas analysis instruments.

Telephones were installed inside and outside the refuge station. These allowed the user to call off-site if necessary. Two-way radios were also installed for quick communication between the outside and the inside of the refuge station if necessary. The entire test was recorded on VHS using a video recorder with a camera installed inside the room. The camera was mounted high on the inner bulkhead. It had excellent remote control panning and zooming capabilities which allowed all the details of the test to be recorded for later analysis. The video system was also used by the on-site physician to observe the participants throughout the test period.

INSTRUMENTATION

Sampling Strategy

Remote sampling of CO₂ and O₂ in the refuge station and at the RANA-AIR outlet ports was accomplished by using a sampling manifold designed and built for the study (see Figure 4). It consisted of 8 sets of plastic tubing lines which converged into one line. The lines were equipped with a valve which permitted each to be sampled in sequence. Each sampling line was used to sample a different area of the refuge station. The lines went through the bulkheads and into the manifold. The sampled air was directed through a water trap, a desiccator, a self-regulated

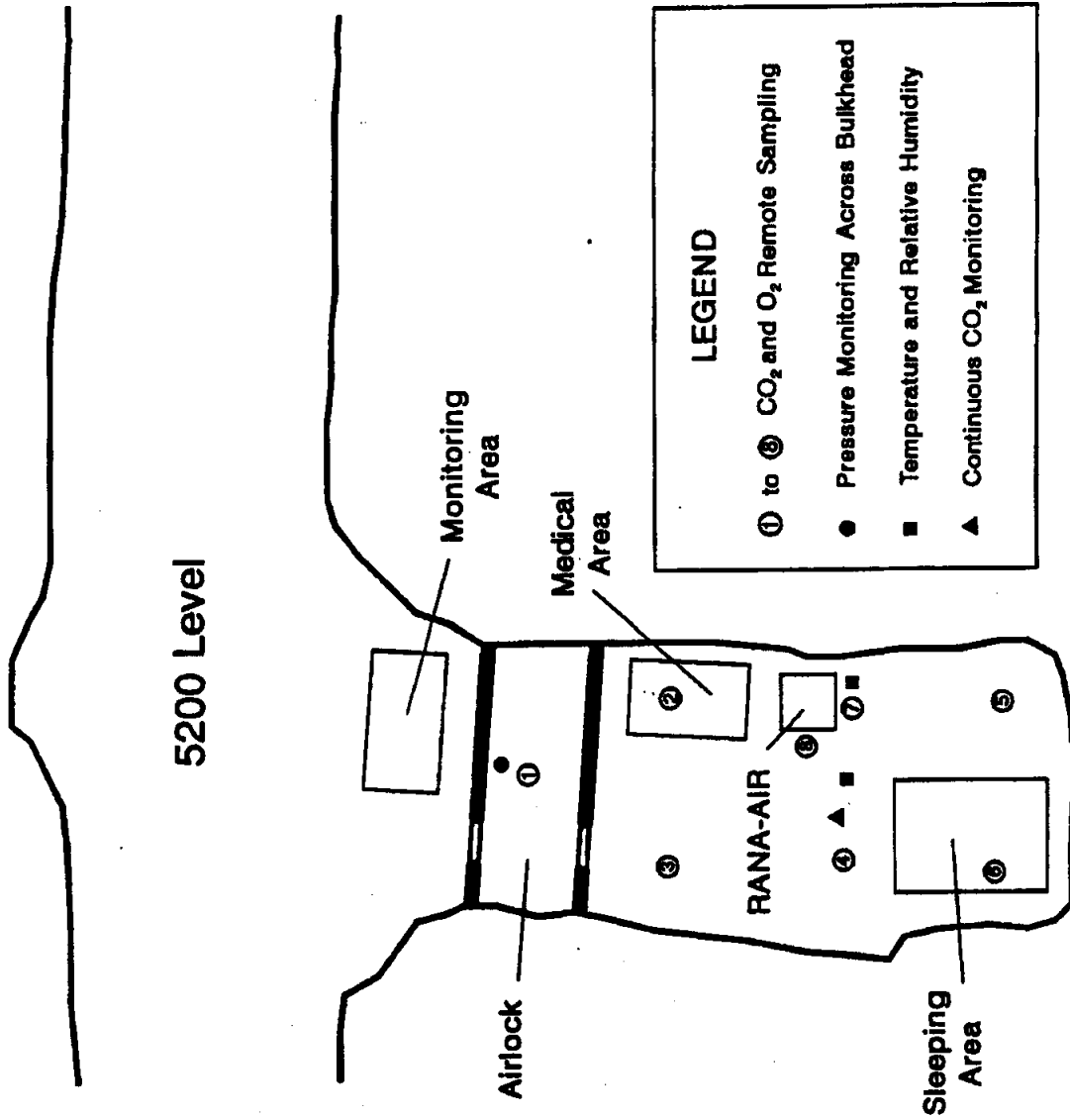

Figure 2. Refuge station schematic plan (not to scale).

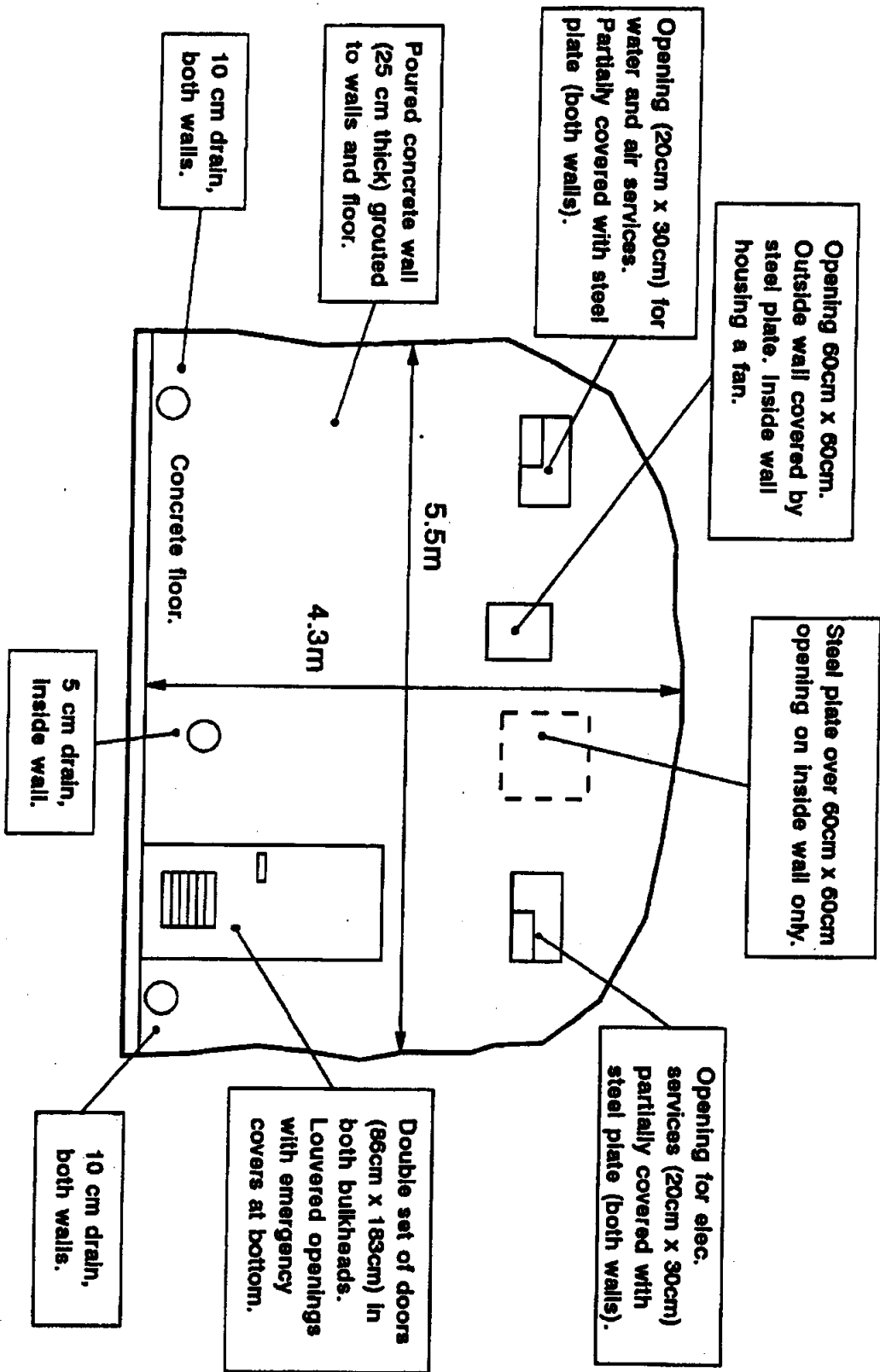

Figure 3. Schematic diagram of the refuge station bulkheads(not to scale).

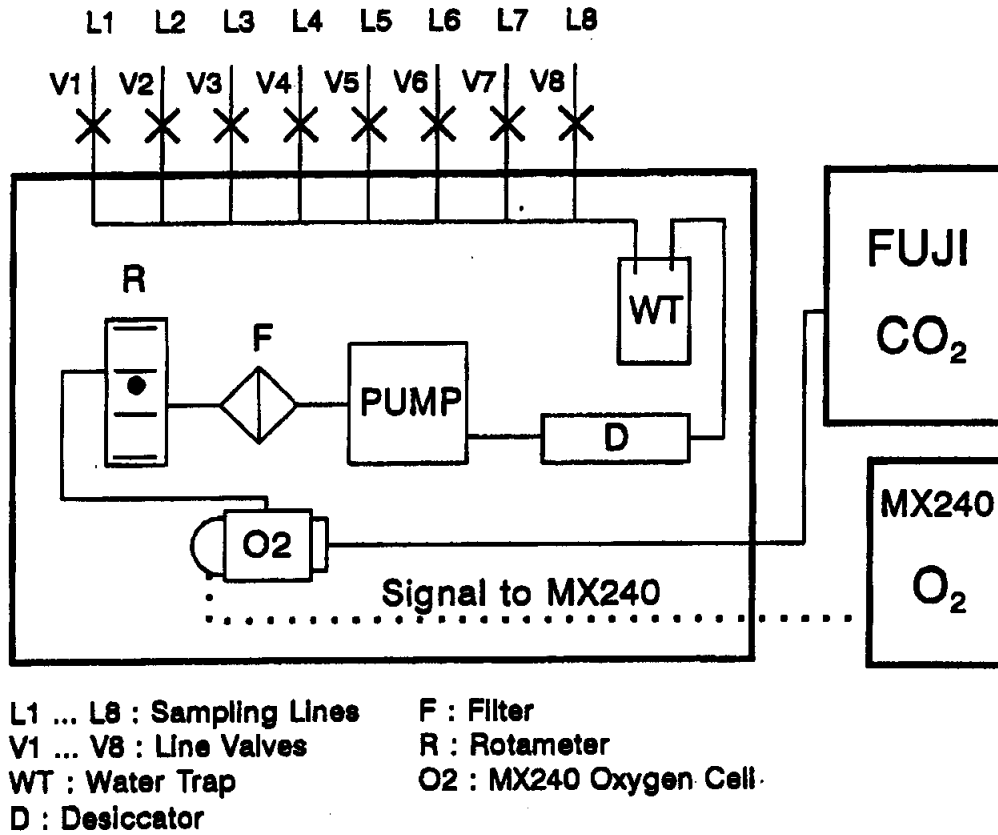

Figure 4. Schematic diagram of manifold assembly.

sampling pump, a rotameter, an in-line O₂ sensor and finally a Fuji ZFP-5 CO₂ monitor. The areas sampled are listed in Table 2. In addition, the pressure across the outside bulkhead was measured using a micro-manometer. The relative humidity and temperature were measured in the refuge station and at the RANA-AIR outlet.

Sampling Port #	Area Sampled
1	Air Lock Area
2	Left at Refuge Station Entrance
3	Right at Refuge Station Entrance
4	Refuge Station Center
5	Left at Back of Refuge Station
6	Right at Back of Refuge Station
7	RANA-AIR Side Drawer CO ₂ Scrubber Outlet
8	RANA-AIR Front Drawer CO ₂ Scrubber Outlet

Table 2. Description of sampling locations inside the refuge station.

Carbon Dioxide Monitoring

Two types of instruments were used to measure concentrations of carbon dioxide. One was a Brüel and Kjaer (B&K) type 1302 Multi-Gas Monitor and the other was a Fuji ZFP-5 analyzer.

The B&K monitor is a very accurate and stable quantitative gas analyzer which operates on a photo-acoustic infra-red detection method. The instrument which has internal data logging capabilities, has a detection threshold of 1 ppm and a repeatability of 1% of the measured value (approximately 30 ppm). The monitor was calibrated in the laboratory prior to the study by using zero and span gases. It is quoted by the manufacturer to require re-calibration every three months. The instrument was operated in the one to 15000 ppm CO₂ range during the study and it was used to continuously sample the carbon dioxide concentration at the center of the chamber.

The Fuji ZFP-5 analyzer operates on a non-dispersive infra-red principle. The ZFP-5 was operated in the high range (0 to 5000 ppm CO₂) where it has an accuracy of 10% of the reading (about 300 ppm CO₂). The instrument was calibrated in-situ at the beginning, the end and half-way through the 24 hour test. Calibration was performed using Matheson nitrogen as zero gas and 3930/44.2 ppm CO₂/CO Matheson certified Standard 2 as span gas. This instrument measured the refuge station's carbon dioxide concentration as sampled through the manifold.

Oxygen Monitoring

Oxygen levels were monitored using an Industrial Scientific Model MX240 gas sampler. This instrument is designed to be used as portable hand-held device and had to be extensively modified to accommodate data logging, in-line sampling as well as the extended sampling period involved with the test.

In order to be able to sample remotely and in an in-line fashion, the O₂ sensor (electro-chemical cell) was removed from the MX240 and the sensor was fixed and sealed at the end of a small

sampling chamber (20 cc). This cell/chamber combination was then wired back to the MX240 component board. The MX240's battery pack was disconnected and DC power was supplied directly to the instrument by an external power supply. Data logging was made possible by connecting a data logger to a 0 to 300 mV signal on the component board which is directly proportional to the 0% to 30% O₂ range of the instrument. The MX240 has an accuracy of $\pm 0.75\%$ in the 0% to 30% O₂ range and it was also calibrated on site using the same zero gas as for the CO₂ instruments and a 20.9% oxygen standard span gas supplied by Industrial Scientific.

Temperature, Relative Humidity and Pressure Monitoring

Temperature and relative humidity inside the refuge station were measured using VH-L probes manufactured by Vaisala. These were connected directly to the data loggers. These probes had been calibrated prior to the study.

Pressure across the refuge station bulkhead during the test and during the bulkhead integrity test were measured by Air Ltd. MP series electronic micro-manometers. Two of these were available, the MP6KD (0 \pm 1999 Pa range) and the MP3KD (0 \pm 199.9 Pa range). Both instruments are accurate to better than 1% of the reading.

Atmospheric pressure was measured using an Airdata ADM-870 multi-meter. This instrument is factory calibrated annually using standards and techniques traceable to the U.S. National Bureau of Standards. The accuracy of the instrument is 2% of reading plus or minus one digit. All data were collected and logged using Grant, 1200 series 12-bit Squirrel meters.

Vital Signs Monitoring

Throughout the test period, blood oxygen content or oxygen saturation percentage was measured using a Nonin model 8500 hand held pulse oxymeter. This instrument also recorded the volunteer's pulse rate. The CO₂ partial pressure in arterial blood was measured with a Johnson & Johnson Critikon Fastrac combination CO₂ and pulse oxymeter. The blood pressure was measured using a standard blood pressure cuff/manometer along with a stethoscope. The breathing rate of the volunteers was measured by performing a 15 second manual count.

TEST PREPARATION

Medical Ethics Considerations

Since human volunteers were asked to be part of the study, a comprehensive description of the test was submitted for medical ethics review, for recommendations and ultimate approval. Two physicians (Department Heads) from St. Michael's Hospital in Toronto, reviewed the test proposal from an ethical and scientific perspective. The proposal included a description of the monitoring instrumentation, action levels with respect to allowable concentrations of CO₂ and O₂ and acceptable ranges in volunteers' vital signs. The submitted proposal was accepted without changes.

As a result of this process, it was agreed that any significant deviation in a volunteer's vital signs as compared to the pre-test medical could result in immediate removal of the person in question.

Furthermore, a sustained pulse rate greater than 110, respiratory rate greater than 20, a systolic blood pressure greater than 140, a diastolic pressure greater than 90 may be deemed as sufficient cause for removal of an individual. In any event, a decision to remove a participant on medical grounds was the sole responsibility of the on-site physician.

In addition to the above parameters, chamber air concentrations of O₂ were not to go below 18%. Sustained CO₂ levels in excess of 5000 ppm would trigger enhanced medical surveillance which would lead to immediate test suspension if the physician had reason to believe that participants were at risk.

Volunteer Selection

Twenty five mine rescue volunteers, in addition to a few spares, were selected several weeks ahead of the test. All participants were chosen from the Timmins area and had to meet the following criteria :

- have been certified fit for mine rescue in the previous six months
- be a non-smoker or be willing to abstain for the duration of the test
- must not be on prescribed medications
- be healthy 24 hours prior to and on the day of the test
- agree to undergo a pre- and post-test medical
- keep a personal log of physical and mental status during the test
- be available for vital signs monitoring during the test

The participants were also asked to follow some dietary rules during the 24 hours preceding the test, such as refraining from drinking alcohol or consuming certain food types which may cause discomfort to the volunteer or his companions. The participants were made aware of the test procedure and were invited to ask questions at a briefing session. Finally, each participant was asked to sign a consent form prior to the test.

Site Preparation

The test site was made ready by ensuring that proper and private sanitary facilities were provided. Communication in the form of telephones and two-way radios was available. An ample food supply and beverages were available to the volunteers. Collapsible cots were provided for the volunteers to sleep in shifts.

Leakage Testing of the Refuge Station Bulkhead

During the week preceding the test, the outside refuge station wall was tested for leaks. This was considered important as the refuge station could not be pressurized with compressed air. The bulkhead is a 25 cm (10 in.) thick poured concrete wall. Both the inside and the outside wall have openings to allow the entry of electrical services as well as the air and water lines (see Figure 3). These openings were covered with steel plates and sealed with fire stop foam and caulking.

After all the openings were sealed, the tightness of the seal was evaluated by slightly pressurizing the refuge station using the compressed air line. The following procedure was used :

- Seal the outside wall,
- Mount a set of critical orifices on the compressed air line in order to measure the air flow into the refuge station,
- Mount a micro-manometer across the outside wall to measure the pressure differential between the refuge station and the main drift,
- Seal the inside door of the outside wall with fire clay,
- Turn on the compressed air and wait for the pressure to come to equilibrium,
- Measure the atmospheric pressure as well as the wet and dry bulb temperature in order to determine the air density,
- Measure and record the pressure across the outside wall,
- Repeat the test at different compressed air flow rates,
- Evaluate the wall leakage against known standards.

From this pressure test, the following information was obtained :

Variable	Test #1	Test #2	Test #3
Atm. Pressure (kPa)	117.2	117.2	117.2
Wet Bulb Temp. (°C)	18.9	18.9	18.9
Dry Bulb Temp. (°C)	22.2	22.2	22.2
Orifice Pressure (Pa)	1543	912	1878
Press. Across Wall (Pa)	366.0	250.3	459.8
Press. Across Wall (in. w.g.)	1.47	1.01	1.85
Air Flow into Chamber (m ³ /s)	0.022	0.017	0.024
Air Flow into Chamber (cfm)	46.98	36.2	51.74
Leakage Rate (L/min./m ² @ 50 Pa)	22.43	20.96	21.83
Leakage Rate (cfm/ft ² @ 0.2 in. w.g.)	0.074	0.069	0.073

Table 3. Results of the refuge station wall leakage/pressure test.

As noted above, the outside refuge station wall is solid poured concrete, but it has several potential leakage points, including the doors and frame, the service openings and the drift wall/concrete bulkhead point of contact.

The average leakage rate across the refuge station wall was 21.74 L/min./m² @ 50 Pa (0.072 cfm/ft² @ 0.2 in. w.g.). This falls within the published values for leakage through cast concrete elevator shaft walls (73 - 136 L/min./m² @ 50 Pa) and fire escape stair wells (3 L/min./m² @ 50 Pa) (3). These leakage rates consider all leaks through walls, closed doors and openings at the top of the shaft and in walls.

Comparing the measured leakage rates with those cited above, the refuge station wall can be considered to be well sealed. When using the compressed air during an emergency, leakage is not normally considered an issue as smoke and gases are kept out through pressurization of the refuge station. However, leakage can be an important consideration when using a life support system such as the one tested in this study. The unit does not generate any appreciable pressure within

the refuge station which means that the implementation of this technology will have an influence on the design and sealing of refuge station walls.

Equipment Testing

On the day preceding the actual test, a dry run was performed in order to evaluate all of the equipment which would be used during the study. The air monitoring instruments and the RANA-AIR unit performed well. The sampling and monitoring instruments were left running until the following morning when the actual test began.

TEST DESCRIPTION AND SCHEDULE

The evaluation took place over a weekend. The participants started to arrive around 5:00 on Saturday morning. While CANMET and Rimer-Alco staff went directly underground to perform a last check of the site, volunteers were undergoing the pre-test medical and briefing. Food was brought inside the refuge station. By 6:20 all of the instruments had been checked and re-calibrated.

The 25 volunteers arrived on site at 7:29. By 7:36 all had entered the refuge station. Six minutes later both the RANA-AIR system drawers had been filled with CO₂ scrubbing granules and the prototype was operational. By 7:46 the outside door on the outer bulkhead was sealed with fire clay and the volunteers settled in for the 24 hour test.

At 14:50 the fire clay seal on the outside door on the outer bulkhead was checked and re-sealed to ensure the integrity of the seal. At 15:05 the other door (inside door) on the outside bulkhead was also sealed. Between 5:04 and 5:10 on Sunday morning, the RANA-AIR system was stopped and the scrubbing material in both drawers was changed. At 5:22 the participants started to get ready to leave the refuge station and so activity increased markedly. At 6:45 the volunteers were asked to perform an agreed upon exercise routine to try to raise the CO₂ concentration and to note the effect on levels of CO₂ and O₂. This was done in order to simulate an increased activity level which could, for example, occur if a mine rescue team entered the refuge station during a real emergency. This exercise period lasted 5 minutes.

At 7:15 on Sunday, the volunteers were ready to leave the refuge station. At 7:36 the door seals were broken, the participants left the refuge station at 7:40 and went back to surface for the post-test medicals. The monitoring instruments were then re-calibrated to verify that none had drifted during the latter part of the test.

RESULTS

Chamber Conditions

This section summarizes the results of refuge station monitoring during the 24 hour test. CO₂ and O₂ concentrations, relative humidity and temperature, and other data are listed.

Figure 5 shows the pressure measured in Pascals across the bulkhead during the actual test while volunteers were in the refuge station. The only conclusion which can be drawn from these data is that the pressure varied around zero during the entire test. Some larger negative and positive swings can be observed which were caused by events linked to production (operation of ventilation doors, fans and cage movement).

Figure 6 shows the CO₂ concentration as measured by the B&K monitor at the center of the refuge station. Noted on the graph are some of the events which may have affected the gas concentrations. The concentration increased from a background of about 700 ppm to stabilize at an average of 2500 ppm after the volunteers had entered and started the RANA-AIR system.

CO₂ concentration was fairly stable, until about 21:00 on Saturday evening. At that time, the volunteers' activity went down noticeably, which is reflected in a stable and slightly lower value of CO₂ concentration between 22:00 and 5:00 the following morning. There is a small peak at 5:00 when the scrubber drawers were changed. The entire process took 6 minutes to complete and it had no significant or long term impact on the air quality. The exercise program which lasted 5 minutes caused the concentration of CO₂ to increase to a maximum of about 3300 ppm. This was performed at the end of the test and data are not available to verify that concentrations would eventually return to the previous average level of 2500 ppm.

Figure 7 shows the CO₂ concentration measured at sampling points 1 to 6, respectively. One overall observation is that there is no evidence of significant differences in CO₂ conditions as a function of location in the refuge station. All curves show that concentration levels increased from baseline to around 2500 ppm.

The only notable difference can be seen in the graph which shows the CO₂ concentration in the airlock. First, the concentration is slightly lower overall (2200 - 2300 ppm) due to the absence of volunteers and limited air circulation in this area for most of the study. Shortly after 15:00 on Saturday, there is a significant increase in CO₂ concentration when the volunteers entered the airlock area to verify the outside door seal and also to apply a clay seal to the inner door. Concentrations slowly returned to 2300 ppm after the volunteers left the airlock area.

Figure 8 shows similar graphs for the O₂ concentration at sampling points 1 to 6. The concentration profiles are also near identical, regardless of the area being sampled. The O₂ concentration varies in a very narrow range between 20.2% and 20.6%. The variation pattern in O₂ concentration goes from high at the beginning of the test, to low towards the middle and back up to high towards the end of the test. The initial decrease in concentration is probably caused by the amount of activity in the first half of the study. Then, as the participants rested on Saturday evening, the O₂ levels start going back to the initial test values.

Figure 9 shows the temperature and relative humidity profile in the refuge station. These measurements were taken close to the RANA-AIR air intake and may not be totally representative of the average conditions in the room. Because of technical limitations with the temperature probe hardware, the sample had to be taken closer to the floor and it is likely that refuge station temperatures were slightly higher on average than the values shown on the graph.

The temperature increased quickly between 7:30 and 9:30. This increase resembles the initial CO₂ increase and is probably caused by the combined influence of the presence of the 25 volunteers

Tommyknocker II Pressure Across Refuge Station Wall

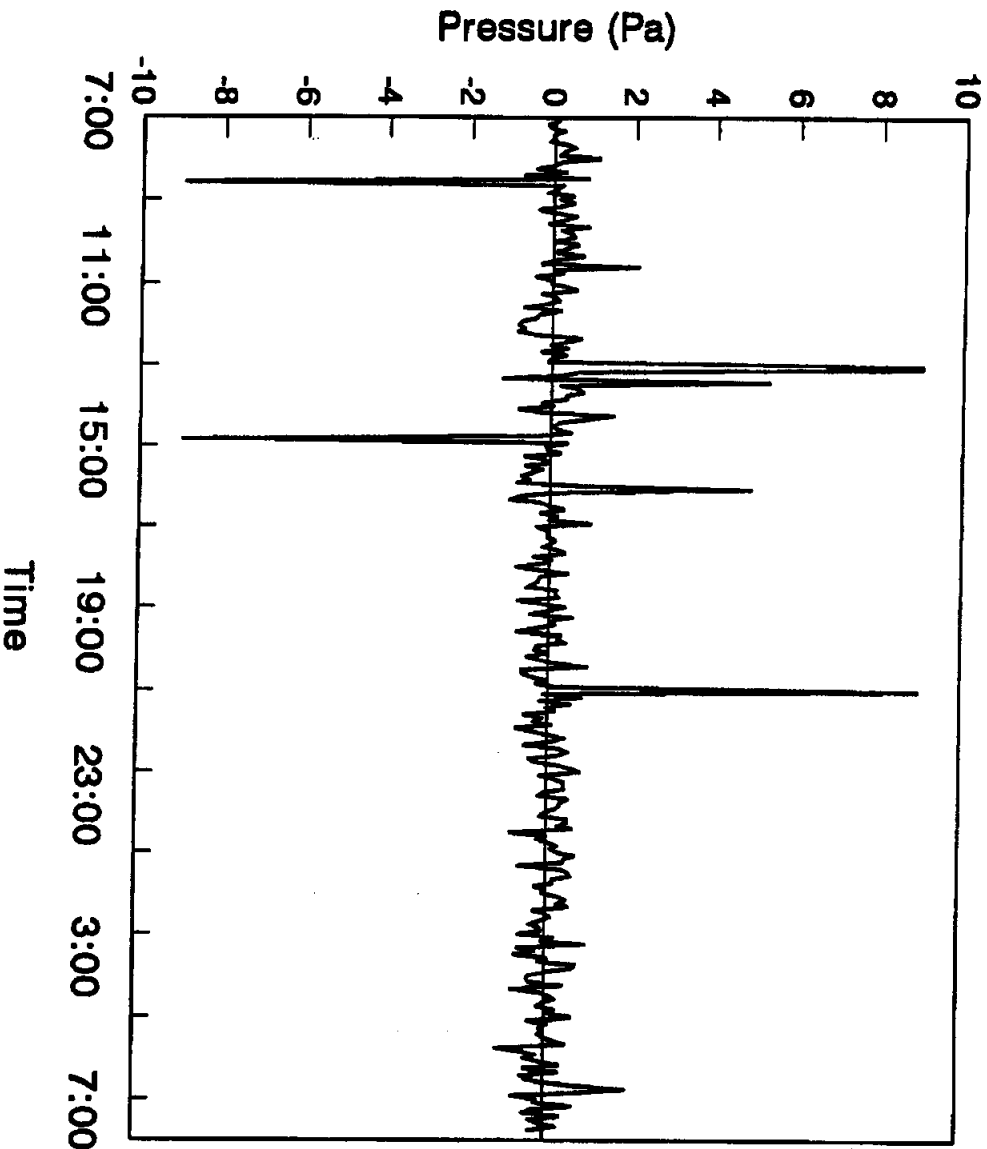

Figure 5. Differential pressure across refuge station bulkhead.

Tommyknocker II CO₂ Concentration (ppm), Room Center (B&K Monitor)

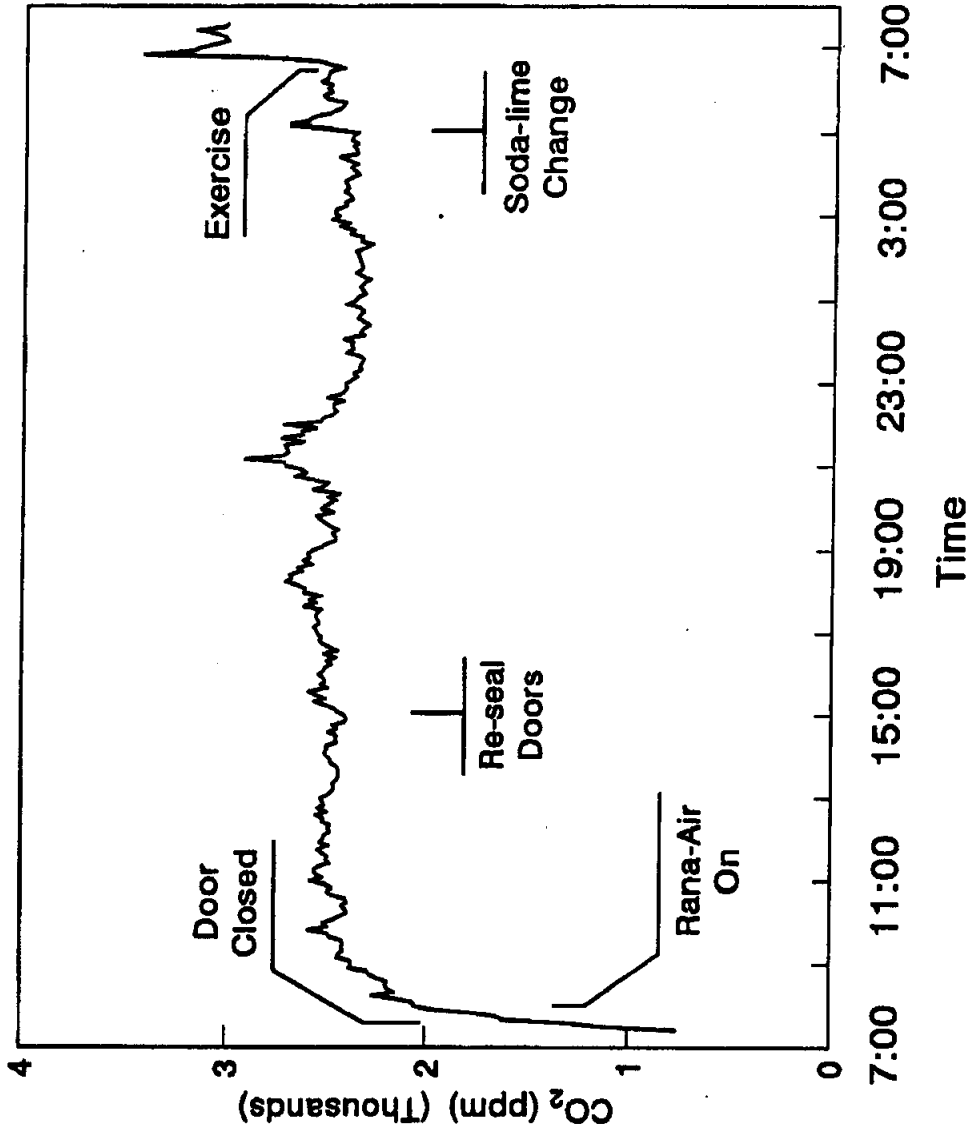

Figure 6. Carbon dioxide concentration in the center of the refuge station.

Ambient Carbon Dioxide Concentration Profiles

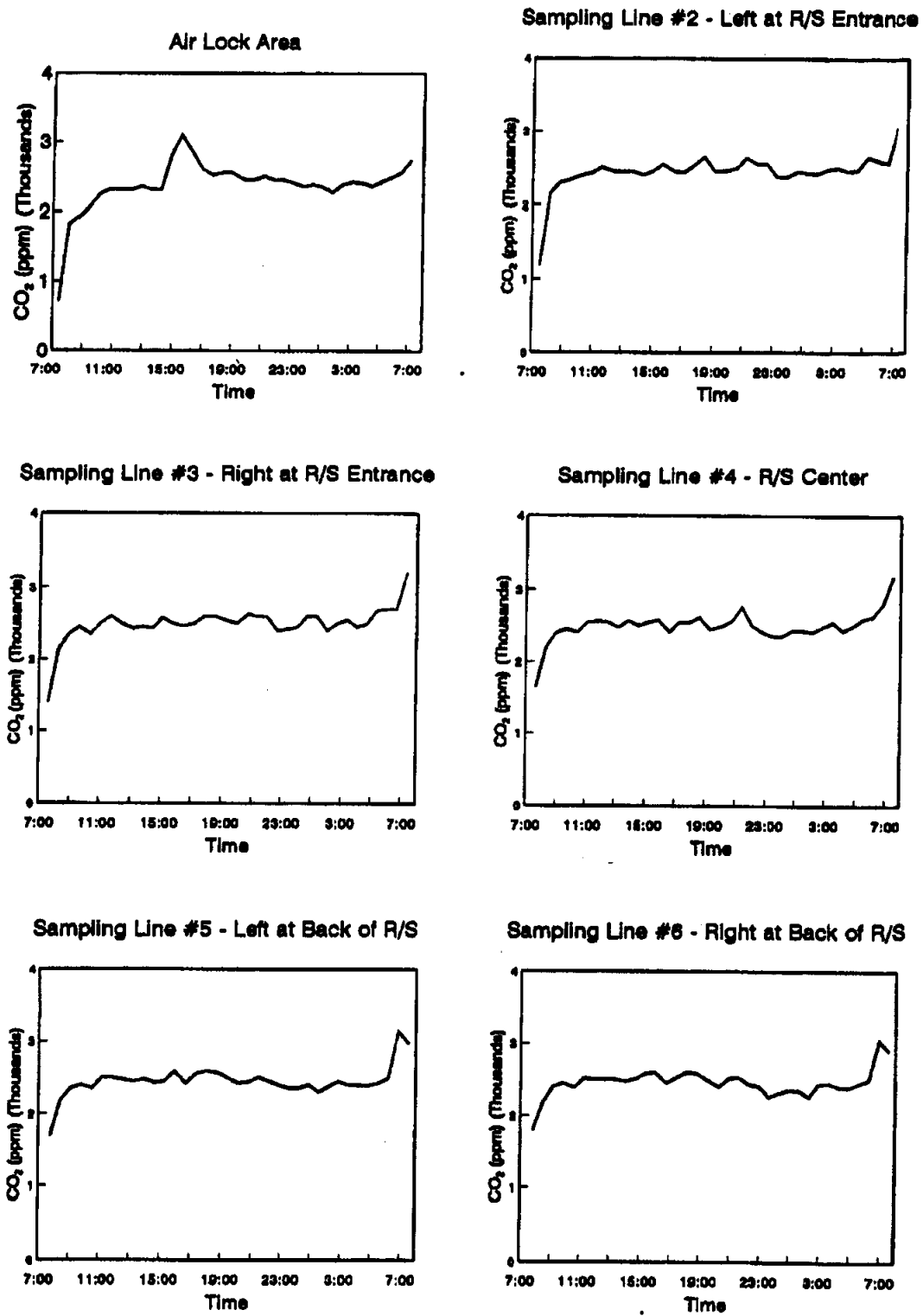

Figure 7. Carbon dioxide concentration in the refuge station.

Ambient Oxygen Concentration Profiles (%)

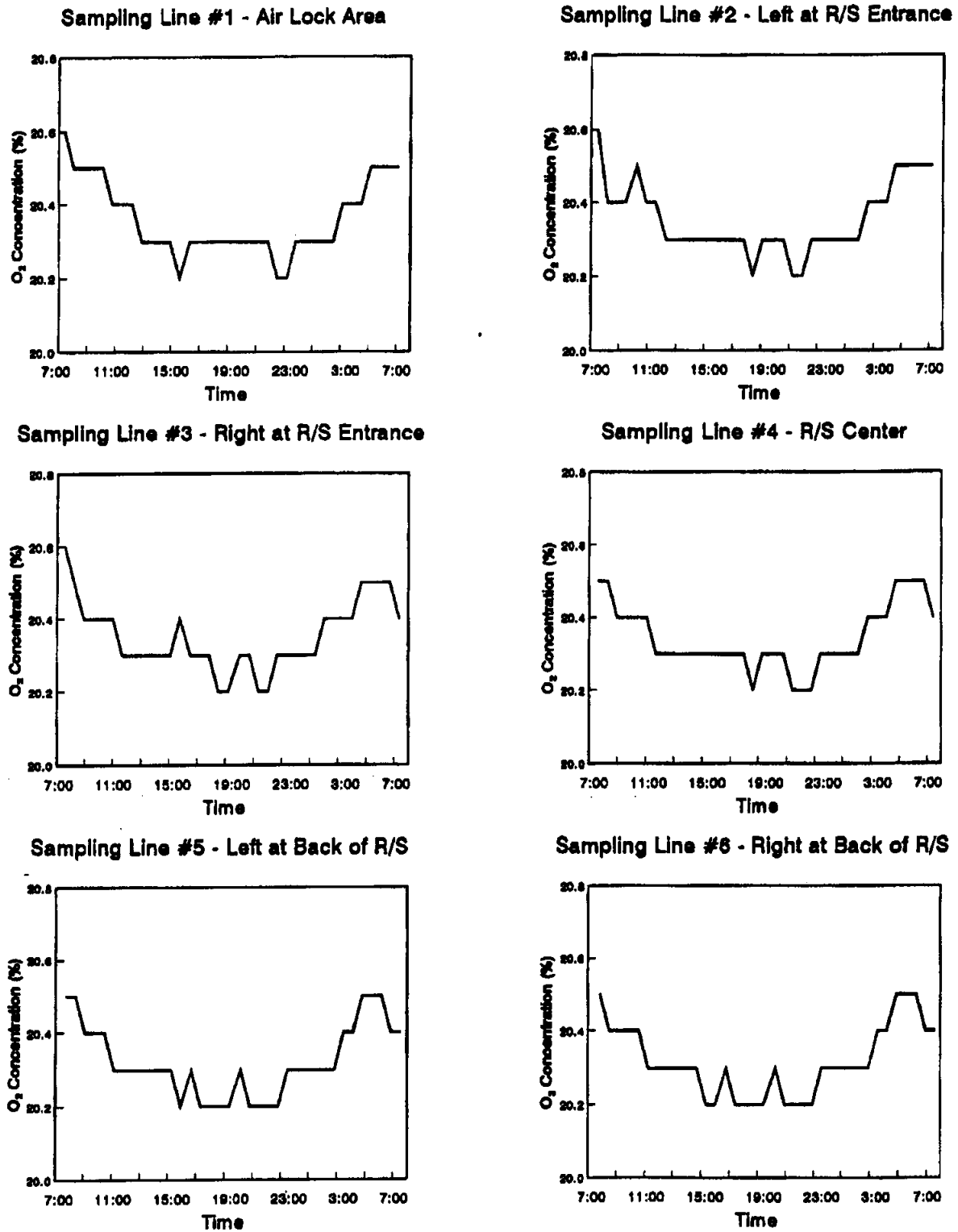

Figure 8. Oxygen concentration in the refuge station.

Tommyknocker II

Ambient Temperature and Rel. Humidity

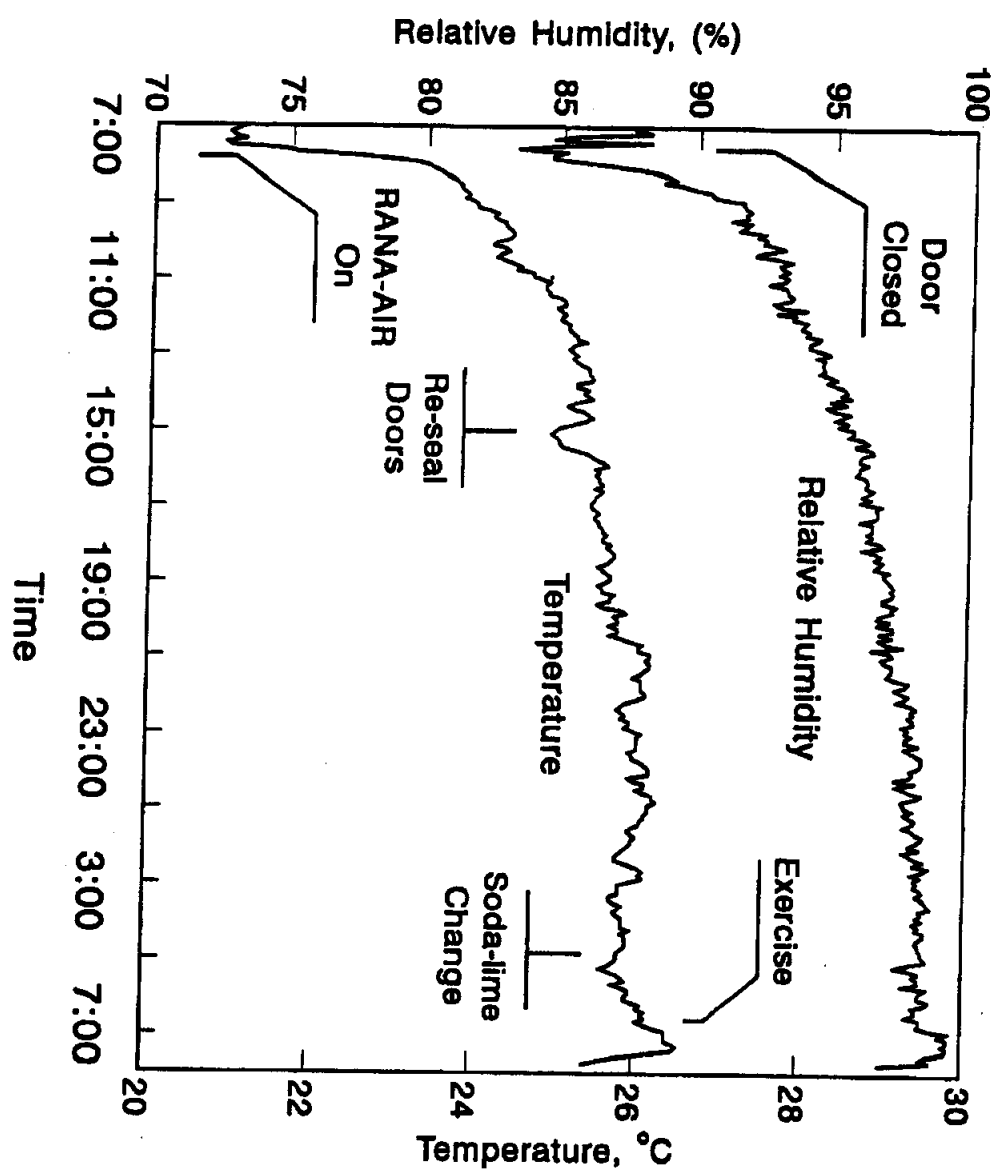

Figure 9. Ambient temperature and relative humidity.

and the heat being produced by the RANA-AIR system. The temperature goes from about 22.0°C, initially, to 25.5°C towards the end of the test. The relative humidity was quite high throughout the test, starting at around 80% and rising gradually to about 98% in a profile which is very similar to the temperature graph.

Carbon Dioxide, Oxygen, Relative Humidity and Temperature at the RANA-AIR Outlets

The above parameters were measured directly at the air outlet of the RANA-AIR system. CO₂ and O₂ were measured on both the front and side drawer outlets while humidity and temperature were only measured on one of the two outlets.

The CO₂ concentration profiles are shown in Figure 10 for the side and front drawer outlet air. The results show some definite differences between both drawers. Whereas the side drawer outlet CO₂ concentration remained unchanged until the scrubbing chemical was changed, the front drawer started showing signs of loss of effectiveness at around 23:00. The side drawer outlet concentration remained constant at around 700 ppm throughout the study. The front drawer outlet was initially much lower at 350 ppm and remained fairly constant until about 20:00. From then, until the drawers were changed at around 5:04 on the following morning, the CO₂ concentration out of the front drawer quadrupled to around 1500 ppm. After the drawers were replaced, the CO₂ concentration returned to 600 ppm for the front drawer 700 ppm for the side drawer.

The O₂ concentration profiles measured from the side and the front drawers are shown in Figure 11. The two curves are very similar, as they both follow the same trend as the O₂ profiles discussed earlier. This is to be expected since the pure oxygen supplied by the RANA-AIR at a constant rate of flow is mixed with room air which is passed through the scrubbing drawers.

Figure 12 shows the temperature and humidity measured at the RANA-AIR output. These curves are very similar to the ones measured in the chamber air. The outlet temperature is, however, 4°C warmer than the chamber air, indicating that the unit is a source of heat in the refuge station. Also, the relative humidity is sensibly lower in the outlet. Both graphs clearly show the point in time when the scrubbing drawers were changed (approximately 5:00 Sunday morning).

RANA-AIR Oxygen Flow Rate/Pressure and Color Change Indicator Observations

The rotameter indicating the oxygen flow rate from the compressed O₂ cylinders was set at 13.0 L/min. from the start of the test. This is approximately equivalent to 0.5 L/min. per participant, which is the O₂ flow required according to the operating instructions. This rate was verified throughout the test and did not change according to the volunteers' observations.

The oxygen cylinder pressure as recorded from the pressure gauge preceding the one stage regulator decreased in a linear fashion going from 2200 psig at the start of the test to 500 psig the following morning when the test ended. The O₂ pressure values are plotted as a function of time in Figure 13. Extrapolation of this line back to zero pressure indicates that the O₂ supply would, at best have lasted another 6 hours or until around 13:00 on Sunday.

Color indicator observations are shown in Table 4. It is important to study this parameter in a little more depth, since in an emergency situation, users would depend on this parameter to

Tommyknocker II CO₂ Concentration (ppm), Ports #7 and #8 RANA-AIR Outlets

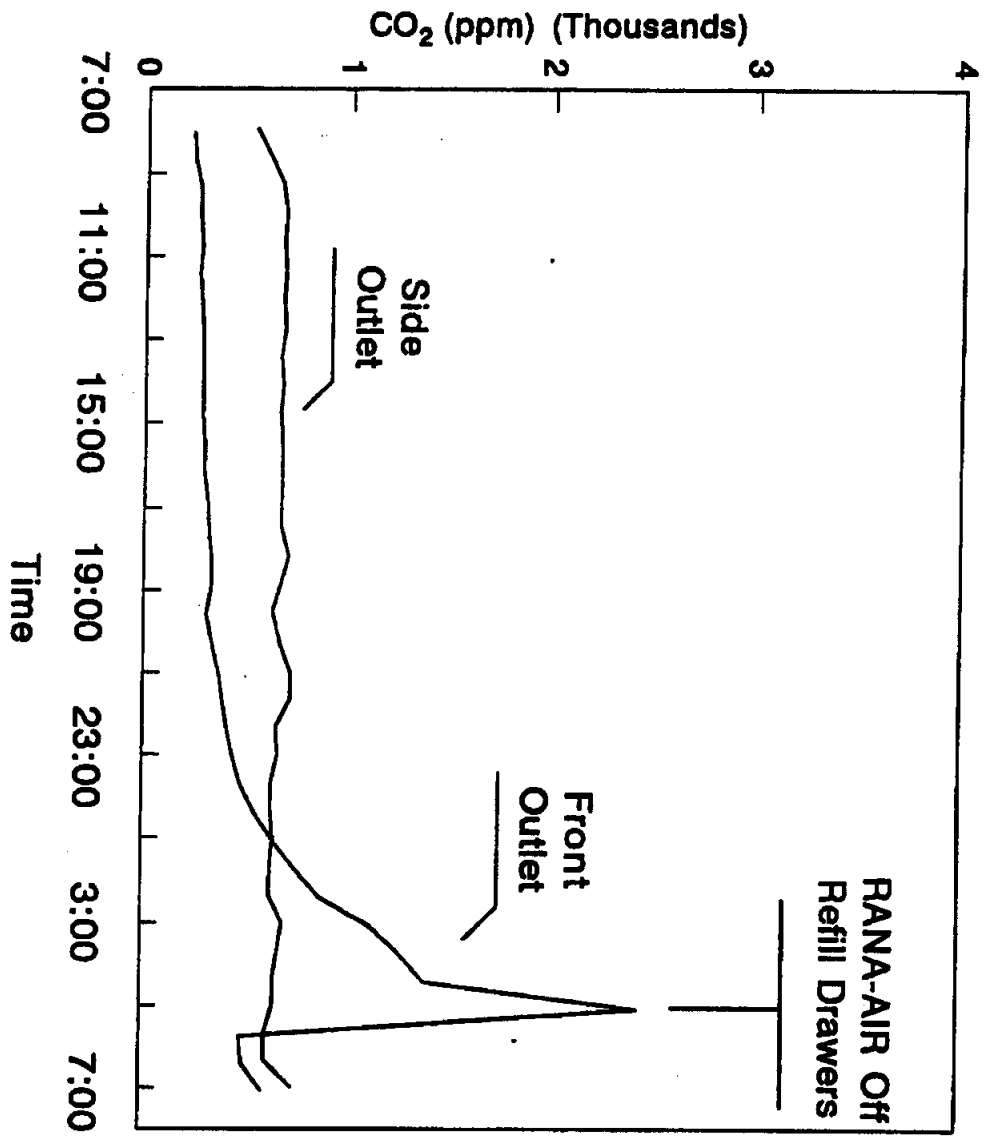

Figure 10. Carbon dioxide concentration at the RANA-AIR outlets.

Tommyknocker II O₂ Concentration (%), Ports #7 and #8 RANA-AIR Outlets

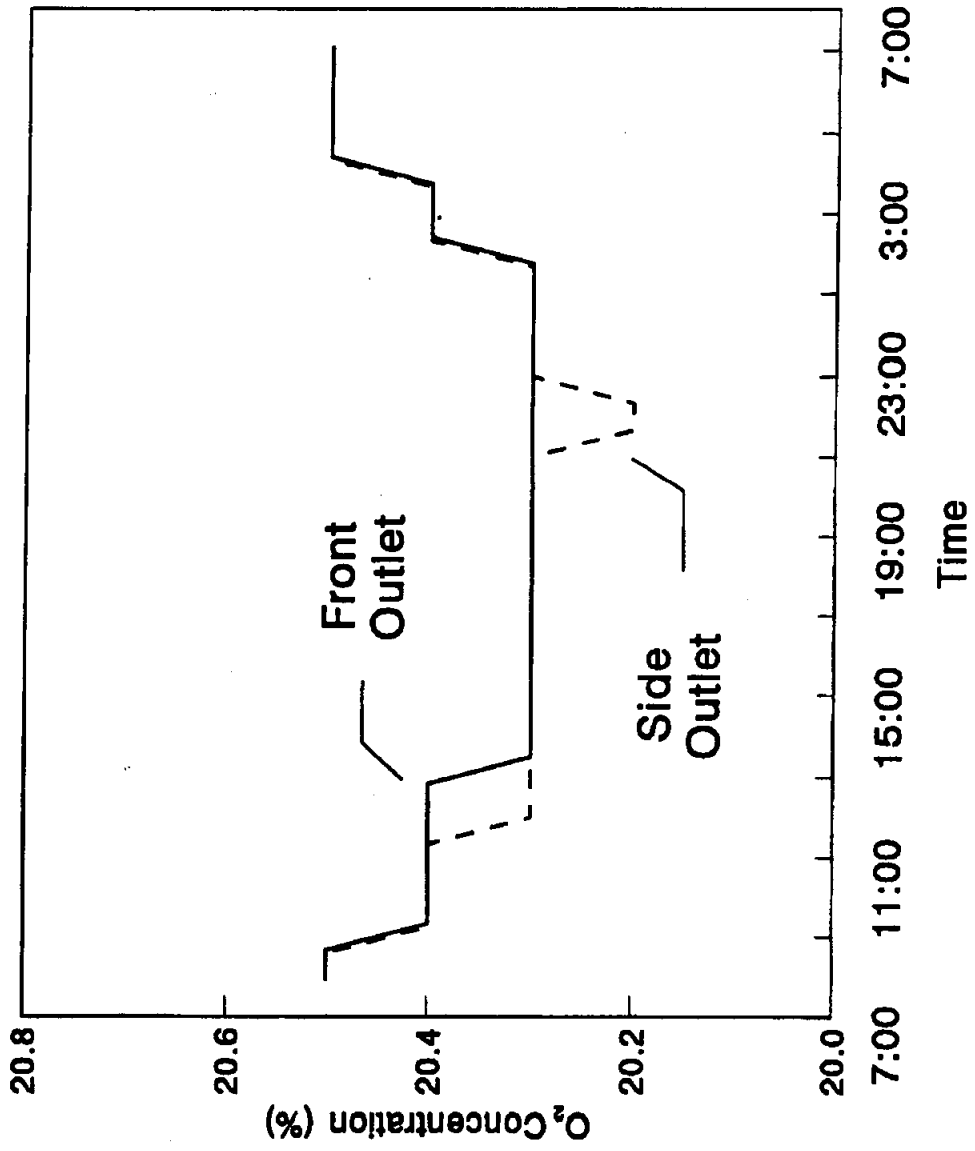

Figure 11. Oxygen concentration at the RANA-AIR outlets.

Tommyknocker II RANA-AIR Outlet Temperature and Rel. Humidity

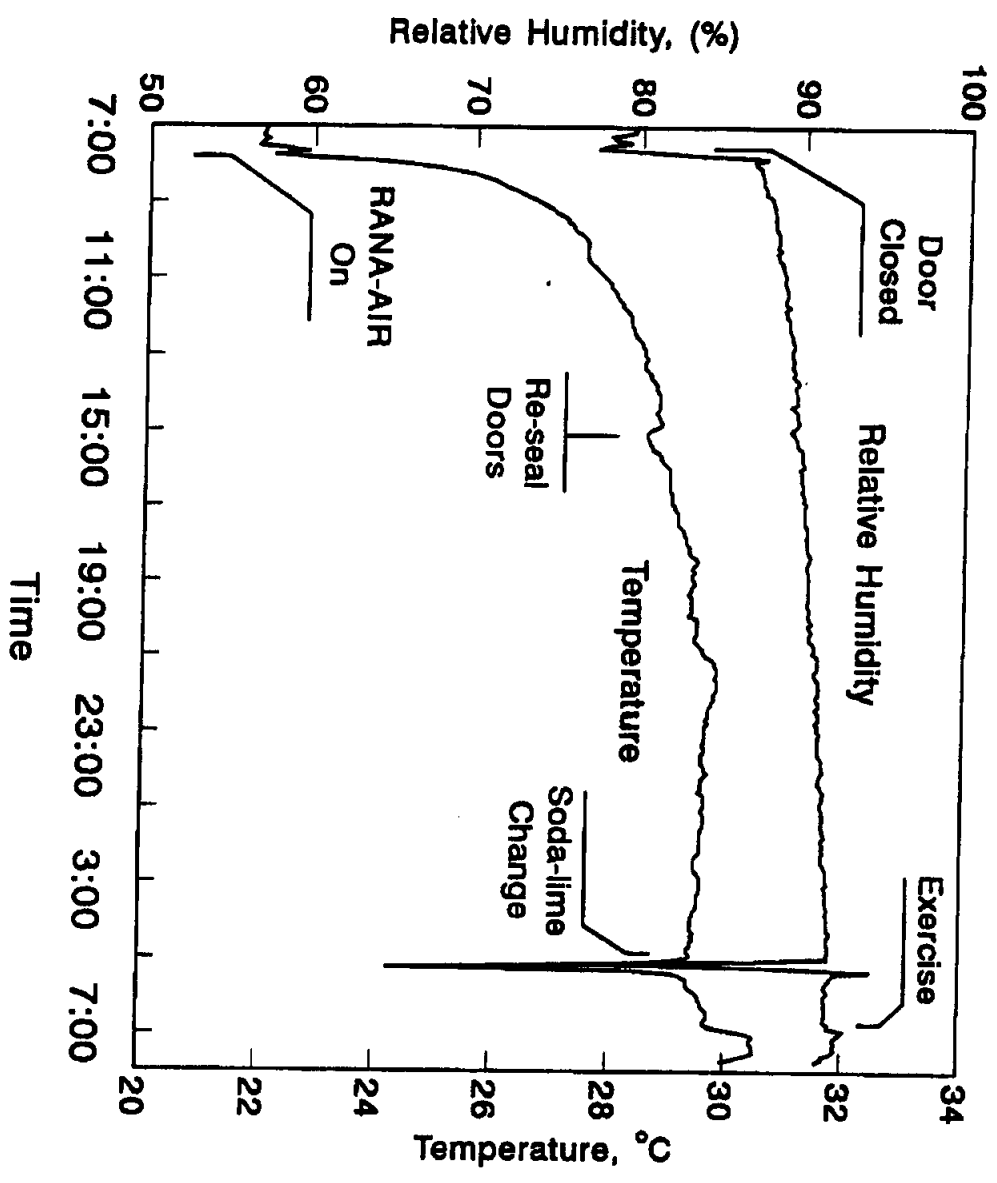

Figure 12. Relative humidity and temperature at the RANA-AIR outlet.

Tommyknocker II O₂ Cylinder Pressure

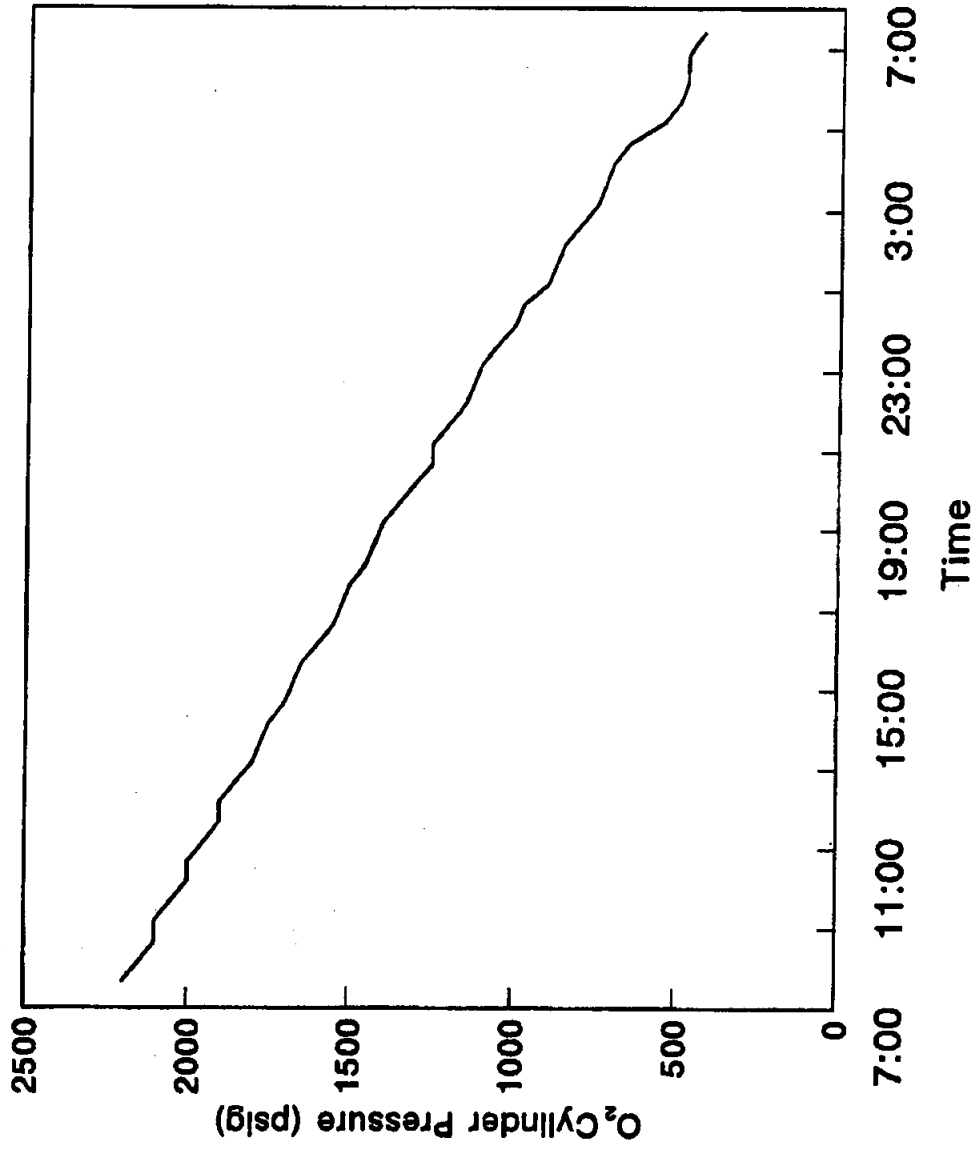

Figure 13. Oxygen cylinder pressure.

estimate the scrubbing chemical efficiency. This information should be compared with the CO₂ concentration graphs obtained from the RANA-AIR outlets and the dimensions and capacities of each scrubbing drawer.

The color indicator observations were obtained by estimating the extent of the scrubbing material color change using a ruler on the window on the front of the drawer. As the scrubbing granules lose their effectiveness, they will gradually turn purple starting from the bottom of the drawer where air enters. In theory, in a perfectly packed chemical drawer and with an even flow distribution across the surface of the drawer, one would expect a straight line formed by the advancing front of the color indicator. In practice, however, this line is unlikely to progress in such a fashion across the observation window.

Time Span	Observations	
	Front Drawer	Side Drawer
7:40 - 11:40	No change	No change
11:40 - 14:10	Few granules changed	No change
14:10 - 15:40	Indicator line @ 6.4 cm	No change
15:40 - 16:40	Indicator line @ 7.6 cm	No change
16:40 - 17:10	Indicator line @ 7.6 cm	Few granules changed
17:10 - 18:40	Indicator line @ 7.6 cm	Indicator line @ 5 cm
18:40 - 19:10	Indicator line @ 10.2 cm	Indicator line @ 6.4 cm
19:10 - 19:40	Indicator line @ 12.7 cm	Indicator line @ 7.6 cm
19:40 - 22:40	Indicator line @ 12.7 cm	Indicator line @ 8.9 cm
22:40 - 23:40	Indicator line @ 12.7 cm	Indicator line @ 11.4 cm

Table 4. Scrubber material color indicator observations.

No color change took place in the first 4 hours of the study. After that time, the front drawer started showing some indicator change in the form of a few granules having turned purple. By 15:40 or almost 8 hours into the test, the front drawer had developed an indicator line at around 6.4 cm from the bottom of the window, while the side drawer showed no indicator change. The observations at 16:40 revealed a line at 7.6 cm for the front drawer and a few purple granules for the side drawer. By 23:40, the front drawer line was up to 12.7 cm while the side drawer had a distinct line at 11.4 cm. After that time, there seemed to be little change in the state of the indicator and records were no longer kept. One thing to mention is that the indicator lines were not clear cut horizontal lines. These lines were a bit diffuse, high at the sides and low in the middle for the front drawer and slanting from right to left for the side drawer.

From the graph showing the CO₂ concentration at the outlet of the front drawer (Figure 10) it appears that the participants should have changed the front drawer granules by 23:00 as the CO₂ concentration from that point on goes up rather rapidly. This is an indication that the scrubbing material in the front drawer is reaching the end of its useful life. At that point in time, the participants did not feel compelled to change the scrubbing material, based on the color indicator observations.

Vital Signs

Table 5. lists the average vital signs values for the 25 participants. On average, around 20 readings of pulse, respiratory rate and O₂ blood saturation were taken on each participant. Blood pressure was measured eight times and trans-cutaneous CO₂ partial pressure in arterial blood was measured once on 11 volunteers.

Vital Sign	Average Measured Value
Pulse Rate (per minute)	76
Respiratory Rate (per minute)	16
Blood Pressure (mm Hg)	119/78
Oxygen Saturation (%)	97.6
Carbon Dioxide Pressure (mm Hg)	47

Table 5. Average of vital signs monitored on the 25 volunteers.

Vital signs results for individual volunteers are listed in Appendix I. From this table it is evident vital signs were within normal ranges for all participants. The results of pre- and post medical examination also failed to reveal any abnormal conditions or any acute medical problems.

Volunteers' Comments

The comments gathered as part of the survey of volunteers are listed in Appendix II. These have been re-organized and listed for all participants under the particular question headings. Otherwise, the comments have been transcribed directly as given by the participants. The questions in the survey may be separated into two main categories. First, comments regarding the actual RANA-AIR unit performance; and, finally, comments on the general level of comfort both physical and psychological.

Concerning the system performance as perceived by the inside volunteers, the comments were very positive. The consensus amongst the volunteers was that the unit was easy to use and that the operating instructions were clear and concise. The system's dimensions, color and shape was acceptable to most, while some mentioned that it should be smaller in size and made of lighter material. Perhaps a cast plastic housing could be used to achieve this and remove sharp edges and corners. Drawers were found by some to be heavy which made them hard to handle. The noise produced by the system's blowers was not a problem, a few mentioned that the noise was comforting.

Some comments were made with respect to the ability to gauge the level of performance of the scrubbing granules using the color indicator as viewed through the drawer window. The indicator's color pattern and the rate of progression up the window was not as obvious and predictable as what had been anticipated. This could lead to difficulties in assessing the efficiency of the scrubbing drawers in actual emergency situations especially if the users have had little or no experience with the RANA-AIR system. One participant mentioned that the unit should have built-in CO₂ and O₂ monitoring capabilities.

The level of comfort in the refuge station seemed to be acceptable. The level of humidity and the lack of space were the major sources of discomfort. Volunteers as a rule were enthusiastic and very much enjoyed their contribution to the test.

DISCUSSION

One of the objectives of this test was to evaluate the RANA-AIR's performance from the point of view of its ability to perform in a real refuge station with a large number of miners inside. This included verifying the user friendliness of the system, its ability to maintain safe levels of CO₂ and O₂ and finally, ensuring that the color indicator method of checking the scrubbing material performance was adequate.

From the test results and the volunteers' comments, the prototype performed very well overall. CO₂ concentrations in the room were on average 2500 ppm and very stable even after the front scrubbing drawer started to decline in efficiency. The exercise program which lasted about 5 minutes caused the concentration of CO₂ to rise to 3500 ppm and stabilize momentarily, before starting on a downward trend.

It is important to compare the average concentration of 2500 ppm, measured during the test, to exposure limits set by existing regulations and to conditions which could arise as a result of present refuge station procedures in Ontario. First, it can be calculated that the CO₂ concentration during this test would have reached in excess of 60,000 ppm if compressed air was not used and the life support system had not been scrubbing CO₂. Under these conditions, unconsciousness would have occurred within a few minutes.

Secondly, the Ontario Regulation 833/90 states that the exposure of workers to carbon dioxide is to be less than 5000 ppm over an 8 hour shift and a 40 hour work week and that this exposure value must be prorated for extended work schedules. In effect this would have resulted in a prorated TWAEV of 1666 ppm for this test. Although it was not possible to achieve this lower value during the present test, there is no evidence in the literature that extended exposure to levels below 5000 ppm carry any increased health risk.

Theoretical concentrations of carbon dioxide assuming compressed air had been used in the refuge station have also been calculated. Using an oxygen consumption rate of 0.5 L/min., approximately 0.43 L/min. of carbon dioxide would be produced by each volunteer (Table 1). Assuming good mixing of air in the refuge station (Figure 7) and compressed air flow rates of 0.024 and 0.047 m³/sec (50 and 100 cfm) it can be calculated that carbon dioxide concentrations would have reached 7700 and 4030 ppm, respectively.

Figure 14 shows the actual CO₂ concentration in the refuge station along with the theoretical concentrations assuming 50 and 100 cfm of compressed air had been used. The RANA-AIR system maintained concentrations below the theoretically calculated values, but above the required 1666 ppm level required for a 24 hour extended work shift.

Remote sampling of several areas of the refuge station also showed that except for the airlock area, concentrations of CO₂ and O₂ were consistent regardless of the sampling location. This is due to a combination of human movement and the air outlet design of the RANA-AIR system

Tommyknocker II Refuge Station CO₂ Concentration (ppm)

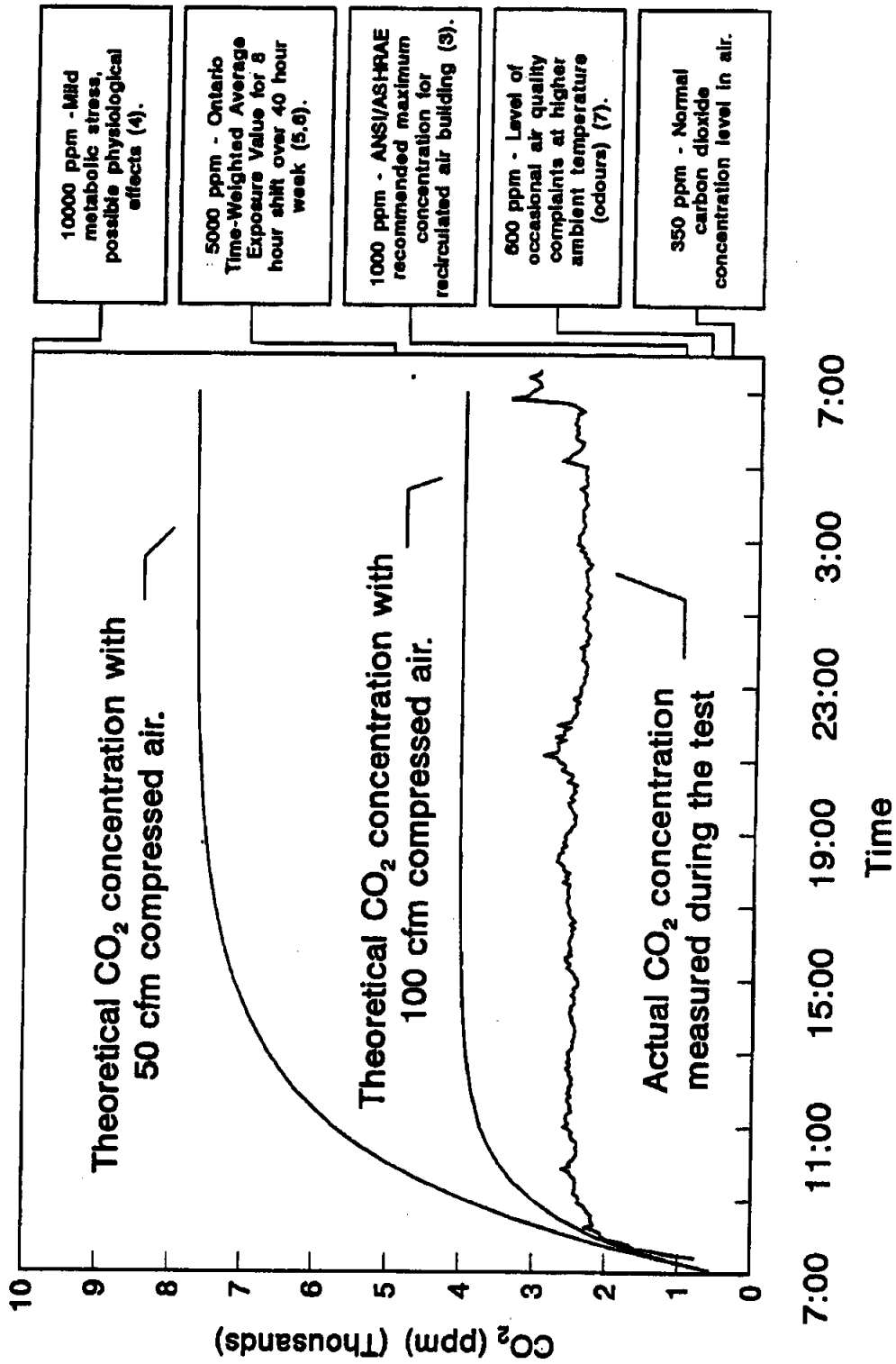

10000 ppm - Mild metabolic stress, possible physiological effects (4).

5000 ppm - Ontario Time-Weighted Average Exposure Value for 8 hour shift over 40 hour week (5,6).

1000 ppm - ANSI/ASHRAE recommended maximum concentration for recirculated air building (9).

600 ppm - Level of occasional air quality complaints at higher ambient temperature (odours) (7).

350 ppm - Normal carbon dioxide concentration level in air.

Figure 14. Theoretical and actual carbon dioxide concentrations in refuge station.

which has blowers coming out of either sides of the console. The airlock area displayed slightly lower CO₂ levels and very similar O₂ concentrations as compared with the rest of the refuge station. The access door of the airlock chamber was left closed for most of the study.

This study also demonstrated that immediate start-up of the system causes CO₂ concentrations to come to quick equilibrium from the initial low values. Whereas the priority of starting the system within the existing refuge station emergency procedure (sealing doors, communication, etc.) has to be determined, it is important to ensure that initial CO₂ levels are not allowed to reach high values. In a real emergency, background CO₂ concentrations in the main drift and inside the refuge station could be high to start with. Reaching safe conditions as quickly as possible should be a key part of the procedure.

The air supplied by the RANA-AIR unit contained on average between 300 and 700 ppm of CO₂, when the scrubbing beds were in place. Considering that the incoming air had on average 2500 ppm of CO₂, the unit had an average scrubbing efficiency of around 80%. It is possible that some of the air bypassed the scrubbing drawers thereby causing the outlet concentration to be higher than it could have been. One indication that this may have occurred is the fact that the scrubbing drawers had significantly different CO₂ output concentrations. Both drawers should in theory have produced low, similar CO₂ output concentrations.

The CO₂ concentrations measured at the outlet of the system also showed that the side drawer far outlasted the front drawer. This can be explained by the difference in geometry of the drawers, the amount of scrubbing material in each drawer and to some extent, the fact that the front drawer seemed to be more efficient at scrubbing CO₂. First, the front drawer contains about 20% less scrubbing granules as compared to the side drawer. Also, the same amount of air flows through both drawers, but the front drawer air throughput area is only 87% of the side drawer area. This would increase the velocity of air through the scrubbing drawer which may in turn increase the incidence of breakthrough of the scrubbing chemical.

The part of the system which supplies oxygen is fairly simple and it performed very well. The levels of O₂ in the refuge station were stable between 20.2% and 20.6%. The temperature traces show a 4°C difference between the intake and outlet air temperature, indicating that the unit is a source of heat in the refuge station. The reverse was observed with relative humidity, with the air intake being at 98% and the outlet at 90%.

From an operational standpoint, the volunteers concurred the system was easy to operate and that the instructions were clear. One participant mentioned that the drawers were heavy and a bit awkward to handle. These, however, fitted well into their respective tracks. The process of removing spent chemical, re-filling and re-starting the unit was performed very quickly and had a minimal impact on the conditions inside the chamber. The entire process which was performed about 22 hours into the test took 6 minutes to complete.

One point which needs to be addressed, with the prototype tested, is the ability of volunteers to determine the proper time at which to change the scrubbing chemical based on the state of the color change indicator. Under normal conditions, (room temperature and low to medium relative humidity) the user could decide to change the scrubbing material when the color change indicator reached any part of the top of the observation window. According to the manufacturer, however,

high humidity conditions can affect the pH reaction which controls the color indicator status. This could lead to errors when trying to estimate the scrubbing drawer efficiency.

As an alternative, the scrubbing material manufacturer recommended doubling the safety margin, and changing the scrubbing material when the average indicator line reaches half way up the observation window. According to the color indicator observations, this situation occurred at around 19:00. Verifying the CO₂ concentration measured at the outlet of the front drawer suggests that this would have been the ideal time to change the scrubbing material. The time coincides with the start of the rapid increase in CO₂ concentration as measured at the outlet of the front drawer.

CONCLUSION

The RANA-AIR unit met and in some respects surpassed the expectations of the test participants. As far as meeting the objectives of the project, it can be said that :

1. the RANA-AIR unit performed well in a realistic refuge station emergency situation and results were consistent with data collected in the first phase study (2),
2. the prototype was easy to operate, the participants agreed that the instructions were clear. The system can be started in less than 10 minutes, which includes filling the drawers with chemical. The system provided safe CO₂ levels (average of 2500 ppm) and maintained O₂ levels within an acceptable range (20.2% and 20.6%).
3. external monitoring of CO₂ and O₂ levels was used to verify the fact that the scrubbing chemical color indicator can be used by inside participants in order to make the decision to change the chemical scrubber,
4. the study provided data and information which will be useful in formulating the requirements needed in order to be able to apply this new technology in U/G emergency situations.

At the onset, it was calculated that the scrubbing material should last between 5 and 9 hour. As it turned out, data shows that in the worst case, the front drawer was still very efficient up until 14 hours into the study. The oxygen supply which was designed to provide 27 hours of service at a rate of 0.5 L/min. per participant performed reliably. Data shows that the cylinders would have lasted close to 30 hours.

The volunteers who will be the ultimate end users, were comfortable and receptive to the technology. The comments dealing with the unit's performance were positive and the volunteers seemed confident in the system's ability to maintain a safe atmosphere (see Appendix II).

The results suggest that two factors should be addressed. First, data showed that the outlet of the front and side drawers differed by a factor of two from the start of the study. Presumably, the side drawer should be as efficient as the front one. It would be interesting to find out what caused the difference. Once the reason is established, the knowledge gained would ensure better CO₂ control and higher overall scrubbing efficiency.

The second factor deals with the volunteers' interpretation of the color change indicator. Knowing that the indicator is affected by high humidity and temperature conditions, the test results show clearly that changing the scrubbing material when the indicator is half way up the observation window would have been acceptable. This would have provided over 10 hours of continuous service before the beds needed to be changed. Alternatively, it is possible to use a fixed time approach in which participants change the chemical after a period of time regardless of the state of the color indicator.

As it applies to the RANA-AIR system, therefore, the scrubbing drawers design should be finalized with respect to depth, overall volume and the requirements for chemical change. There is a possibility to use pre-packaged absorbent cartridges as an alternative to re-fillable drawers. The specification with respect to absorption capacity, color change indicator or replacement frequency should be determined, tested and specified by the soda lime manufacturer in conjunction with Rimer Alco.

The final design of the RANA-AIR system should include a heavy duty casing which will encapsulate the unit in order to protect it from physical damage, the harsh underground environment and also to protect the controls from possible tampering.

In the course of this study, it became apparent that some thought needs to be given to refuge station design. Within the emergency refuge station program, some work is needed in order to assess the impact of low or negative pressure conditions occurring inside the refuge station whether or not compressed air is used. More information is needed on the processes which are at play when the refuge station undergoes the mild pressure swings which were recorded during this study. Knowing that gases will migrate through the concrete bulkhead, we need to know to what extent conditions outside the refuge station can affect the inside atmosphere.

A similar test, although not necessarily requiring the participation of volunteers, could be conducted in which several variables are considered. The refuge station bulkhead could be treated with impermeable substances and tracer gas (SF_6) released in the main drift could be sampled for, inside the refuge station, to quantify the impact of the environment outside the refuge station on inside conditions.

RECOMMENDATION

Upon completion of the field test and after reviewing the study data, the Tommyknocker II Planning and Coordinating Committee collectively recognized that the life support centre concept has the potential to greatly improve the safety of underground workers and that the RANA-AIR prototype, pending some minor modifications could be used underground as part of a comprehensive mine emergency response program.

ACKNOWLEDGMENTS

The authors would like to thank everyone who helped make this project a success; in particular, from Falconbridge Ltd., Kidd Creek Division, Gerry Bilodeau, on-site Project Coordinator, John Chenier, Safety and Security Supervisor and Dr. Gordon Hall and Susan Cahoon, Medical Supervision. Kim Barney, Dr. Albert Cecutti, Norm Dallaire, Walter Fischer, Peter Fleming, Tony Fontana, Allen Hayward, Dennis O'Hare, John Pappone, Vince Patitucci, Len Secord and Leonard Vincent also from Kidd Creek and Don Lenihan of Royal Oak Mines Inc. should be commended for their efforts and a job well done.

Next our appreciation also goes to the twenty eight mine rescue volunteers who gave up their weekend in order to help advance the cause of workplace safety and health. These people were :

Team #1	Team #2	Team #3	Team #4	Team #5
Dean Rigg (C)	Ernie Sapinski (C)	George Rodda (C)	James Fleurie (C)	Darryl Vickers (C)
Camille Bois	Mike Butler	Frank Monfils	Trevor Eagles	Robert Ladouceur
J.C. Cayen	Rick Byrnes	Pat Vaillancourt	Dennis Tomini	Paul Magny
Randy Robitaille	Don Cayen		David Lee	Scotty Robertson
Ron Séguin	Mike Charette		Peter Diproffio	Terry Sprowl
Al Truax	Alex Soucy			

Spares : Jamie Mortson, Kostic Tschop and Nelson Girard.

Our thanks also to Earl Gardiner, Russ Hildebrand and Monty Raber of Rimer Alco North America and Joe MacInnis, Mine Rescue Officer, Timmins. We acknowledge the contribution of Falconbridge Ltd., Kidd Creek Division for hosting this study as well as Placer Dome Inc., Dome Mine and Royal Oak Mines Inc., Timmins Division for their keen interest and help throughout the project. Finally, we would like to thank Northern Voice and Video Inc., Sudbury, Ontario for loaning the high quality video equipment used during this study.

REFERENCES

1. American Society of Heating, Refrigeration and Air Conditioning Engineers, "ASHRAE Handbook, Systems", Published by ASHRAE, Atlanta, Georgia, 1980.
2. "Operation Tommyknocker - Test of Survival Equipment for Underground Refuge Stations at the Underground Research Laboratory", Lac Du Bonnet, Manitoba, March 4th and 5th, 1993.
3. American Society of Heating, Refrigeration and Air Conditioning Engineers, "ASHRAE Handbook, Fundamentals", Published by ASHRAE, Atlanta, Georgia, 1981.
4. American Conference of Governmental Industrial Hygienists, "Documentation of the Threshold Limit Values", Fourth Edition, ACGIH Inc., Cincinnati, Ohio, 1985.

5. American Conference of Governmental Industrial Hygienists, "1993 - 1994 Threshold Limit Values for Chemical Substances and Physical Agents and Biological Exposure Indices", ACGIH Inc., Cincinnati, Ohio, 1993.
6. Government of Ontario, "Regulation Respecting Control of Exposure to Biological or Chemical Agents", RRO 1990, O. Reg. 833.
7. Rajhans, G.S., "Indoor Air Quality and Carbon Dioxide Levels", Occupational Health in Ontario, Vol. 4, pp. 160 - 167, Ontario Government Publications, 1983.

APPENDIX I
VOLUNTEERS VITAL SIGNS

Vital Signs

Table A1. lists the average of vital signs monitoring for each one of the 25 volunteers. Also shown in the table are the standard deviations associated with each average.

Volunteer #	Pulse (per min.)	Respiration (per min.)	Blood Pres. (mm Hg)	O ₂ Sat. (%)	CO ₂ Pres. (mm Hg)
1	72 ± 8	16 ± 2	122 / 81	98.0 ± 0.6	--
2	75 ± 5	17 ± 2	104 / 67	97.4 ± 0.7	--
3	74 ± 7	16 ± 2	112 / 70	97.4 ± 1.0	--
4	82 ± 9	16 ± 3	112 / 78	98.1 ± 0.6	--
5	81 ± 6	15 ± 2	117 / 80	97.7 ± 0.8	48
6	80 ± 7	18 ± 3	122 / 83	98.0 ± 0.6	41
7	83 ± 8	16 ± 2	123 / 85	98.0 ± 0.7	49
8	68 ± 8	16 ± 2	118 / 76	97.8 ± 0.6	--
9	83 ± 8	16 ± 2	118 / 81	97.5 ± 0.7	--
10	53 ± 5	13 ± 2	130 / 78	98.0 ± 0.4	--
11	68 ± 5	18 ± 3	103 / 67	97.4 ± 1.0	--
12	74 ± 6	16 ± 3	130 / 83	98.6 ± 0.5	--
13	74 ± 7	18 ± 2	118 / 77	97.8 ± 0.6	49
14	72 ± 8	15 ± 2	113 / 74	97.2 ± 0.8	44
15	87 ± 6	16 ± 3	125 / 79	97.5 ± 0.6	--
16	72 ± 10	17 ± 3	117 / 77	96.1 ± 2.0	--
17	72 ± 9	14 ± 2	120 / 76	97.0 ± 0.6	--
18	74 ± 6	16 ± 2	122 / 82	97.6 ± 0.7	49
19	76 ± 7	16 ± 2	122 / 83	97.5 ± 0.6	37
20	82 ± 4	16 ± 2	124 / 82	98.1 ± 0.5	57
21	80 ± 8	15 ± 2	115 / 79	97.4 ± 0.8	41
22	80 ± 8	15 ± 2	120 / 78	97.7 ± 0.7	54
23	87 ± 8	17 ± 2	113 / 78	97.2 ± 1.0	--
24	80 ± 8	16 ± 2	128 / 84	97.5 ± 0.8	--
25	70 ± 6	16 ± 2	126 / 81	97.8 ± 0.6	49

Table A1. Average vital signs for the 25 volunteers.

APPENDIX II
VOLUNTEERS COMMENTS AND SUGGESTIONS

**RIMER
ALCO**

**"OPERATION TOMMYKNOCKER-PHASE II"
RANA-AIR MINE REFUGE AIR CENTRE**

"PARTICIPANT COMMENTS AND EVALUATION"

Developing the right piece of equipment for the application we feel can best be achieved by listening to the input of those trained, active, and concerned in the field the equipment will be used and applied. We believe this to be particularly true with safety/life support equipment.

Rimer Alco needs and welcomes your comments and suggestions to properly progress the development of the Mine Refuge Air Centre. Going into the tests at Kidd Creek there were a number of objectives which were to be evaluated and which your feed back on would be valuable to have. In the space provided below please provide your comments on each of the areas, and any other points which you feel would provide benefit to the final design.

1. Did you find the system simple to use and was it easy to operate? What improvements and/or changes would you suggest to improve it in this area?

- 1 *I find the system simple to use.*
- 2 *Yes, it was simple to use and was easy to operate.*
- 3 *Very simple and easy to operate.*
- 4 *It was easy to use.*
- 5 *Yes.*
- 6 *None.*
- 7 *Yes, O.K. to operate.*
- 8 *Yes, very easy to use.*
- 9 *Very easy to understand, even with little underground experience. Perhaps a colour chart for the soda lime might be of value.*
- 10 *Yes, I found the system to be easy to operate. I see no need to improve it.*
- 11 *The system was very nice to use. There were no problems with the instructions at all.*
- 12 *Very simple to start up.*
- 13 *Very easy to use.*
- 14 *Yes, it was easy to use and operate. Make colour change more noticeable.*
- 15 *The system is simple and easy to use.*
- 16 *Yes, it is simple to understand the system. I think there should be no changes to the system.*
- 17 *Yes. None.*
- 18 *Yes.*
- 19 *Yes, the system is simple to use. I don't think it needs any improvements.*
- 20 *Yes, the system was very self-explanatory when setting it up for use. No changes or improvements at this time could or should be made.*
- 21 *Yes.*
- 22 *Yes, simple to use. No improvements suggested. Good instructions on machine.*

2. Based on how you felt and with the information on the Oxygen and CO₂ levels do you feel the RANA-Air system proved its ability to maintain Oxygen and Carbon Dioxide to safe levels?

- 1 *The RANA-AIR System has the ability to maintain oxygen and carbon dioxide to safe levels.*
- 2 *I feel that it is very safe.*
- 3 *Yes, because you could notice when your carbon dioxide levels are getting higher by the discolouring of the soda lime.*
- 4 *Yes.*
- 5 *Yes.*
- 6 *Yes.*
- 7 *Yes,*
- 8 *Very much so.*
- 9 *The machine performed perfectly. No problem to breathing at all.*
- 10 *The system has proven to me that its main purpose has well exceeded its expectations.*
- 11 *The RANA-AIR System surpassed all of my expectations. Its performance was flawless.*
- 12 *Very much so.*
- 13 *Yes.*
- 14 *Yes, it does maintain oxygen and carbon dioxide in safe levels.*
- 15 *Good system. Oxygen and carbon dioxide levels O.K.*
- 16 *Yes.*
- 17 *Yes.*
- 18 *Yes.*
- 19 *Yes it did.*
- 20 *Yes, equipment was found by men inside to work above what we told would happen!*
- 21 *Yes.*
- 22 *Yes.*

3. What other factors existed in the refuge station that were a result of many people trapped in a small area for a prolonged period of time that effected how you felt and how comfortable you were (odour, humidity, noise, stress, temperature, etc.)?

- 1 *I felt the humidity for a prolonged period to become uncomfortable.*
- 2 *It was warm and humid, but if the RANA-AIR System would save your life, why not.*
- 3 *Humidity was the only uncomfortable thing during our duration in the refuge station. The noise was very acceptable, but could have been a little more quiet.*
- 4 *Humidity and temperature.*
- 5 *Humidity and temperature.*
- 6 *ODOUR - Slowly as time goes on, you get used to it. HUMIDITY - is very high. O.K. to sleep for short periods of time. NOISE - O.K. STRESS - not bad. TEMPERATURE - O.K.*
- 7 *Lack of moving air. Ceiling fan would be appropriate.*
- 8 *The humidity and a rise in temperature was acceptable. When the drawers were changed at 5:00 a.m., I noticed a small decrease in temperature.*

- 9 *Humidity was high, and there was a need for more space. Odour was not a problem.*
- 10 *Although there were obstacles encountered in this test, I found that there was very low levels in stress, except for the stress caused by lack of sleep.*
- 11 *It was very humid, and sleeping arrangements came into play. All people in the room became very sleepy after about sixteen hours.*
- 12 *Humidity was the only really uncomfortable factor.*
- 13 *Odour and humidity.*
- 14 *There was a lot of humidity and body odour.*
- 15 *Everything was bearable.*
- 16 *Temperature and too much light.*
- 17 *Humidity should be lower.*
- 18 *Very little odour. Humidity was O.K. Noise was very little. I felt no stress. Temperature was comfortable.*
- 20 *Humidity is very noticeable after eight hours, but bearable over the twenty-four hour period. Temperature (29.4°C) was easy to handle. No problem here!*
- 21 *Shortage of room. You could reduce the noise of the blowers.*
- 22 *Humidity the number-one concern. Temperature the number-two concern.*

4. General Comments/Suggestions Regarding the RANA-AIR Mine Refuge Air Centre:

Is the size, colour and shape of the system appropriate?

- 1 *Yes, size colour and shape are appropriate.*
- 2 *You don't really need storage compartments. Just use the soda lime box when it is not in use. It would decrease the size of the machine.*
- 3 *Size is very compact for the size of this lunch-room (refuge station).*
- 4 *It is a good sized unit.*
- 5 *The size should be smaller.*
- 6 *Yes.*
- 7 *Yes.*
- 8 *I guess it is O.K. What can you say, to me the system did its job.*
- 9 *Perhaps a colour chart for the soda lime might be of value.*
- 10 *Yes.*
- 11 *I would like to see a smaller unit, and the shell could be made of fibreglass, plastic or kevlar. Take all sharp edges away, and maybe have it on wheels. Blue is a calming colour. Maybe this should be considered.*
- 12 *Yes.*
- 13 *Yes.*
- 14 *Size, colour and shape are O.K.*
- 15 *Yes, except smaller soda lime drawers.*
- 16 *Yes.*
- 17 *Size should go with size of refuge station. Colour and shape O.K.*

- 18 *I think it was appropriate for the amount of men we were (twenty-five).*
- 19 *Yes.*
- 20 *This unit is well made. The drawers containing soda lime fitted well into the cabinet!*
- 22 *Could be smaller. Colour is O.K.! Shape is O.K.!*

Did the noise level of the system cause you concern? In a real emergency situation, given the purpose of the blower system, would the noise have added to your anxiety and stress?

- 1 *No, the noise level of the system is worth its purpose.*
- 2 *It would depend on how long the RANA-AIR System is on.*
- 3 *No, not for twenty-four hours, but it could have added anxiety for a longer period of time.*
- 4 *Noise is very low and does not cause any stress.*
- 5 *No.*
- 6 *No.*
- 7 *Noise levels were O.K. Hearing the blower system would, in my opinion, relieve people in an emergency situation, knowing the system is working.*
- 8 *No noise concern to me. But maybe, under different conditions, the noise could add to the level of stress and anxiety.*
- 9 *Not at all. When we changed the soda lime, the absence of the blower was missed.*
- 10 *In a real emergency situation, the little noise caused by this unit would be very welcome.*
- 11 *No, the noise was hardly noticeable with the activity of twenty-five men.*
- 12 *Not at all!*
- 13 *I did not feel the system was noisy.*
- 14 *Noise level was all right. No, it would not have bothered me.*
- 15 *Noise level O.K. No added anxiety or stress. Easier to take than a compressed airline blowing.*
- 16 *No, the noise did not bother me.*
- 17 *Noise is O.K.*
- 18 *I do not think so.*
- 19 *No, I did not find it to be noisy.*
- 20 *No, I personally do not think so because it would give the persons inside the refuge station a feeling of protection by hearing the fan blowing.*
- 21 *The noise level could be reduced.*
- 22 *No. No, because if you can hear it you know it is working.*

Was the labelling on the unit and the description of operation in the manual sufficient to use and operate the system effectively?

- 1 *Yes, labelling and description in manual is sufficient to operate the system effectively.*
- 2 *It is well labelled for anyone to operate the system.*
- 3 *Very effective and sufficient.*
- 4 *Yes.*

- 5 Yes.
- 6 Yes.
- 7 Yes, O.K. to understand.
- 8 I think the information was very clear and straight-forward.
- 9 No problem.
- 10 Yes.
- 11 Everything was very clear and precise.
- 12 Yes, it was.
- 13 Yes.
- 14 Yes, it was good enough.
- 15 Yes, easy instructions.
- 16 Yes.
- 17 Yes.
- 18 Yes.
- 19 Yes.
- 20 Yes.
- 21 Yes.
- 22 Yes, very good instructions!

Referring to the memo posted on the RANA-AIR system as "IMPORTANT INFORMATION" do you like the changes that are proposed in the materials of construction and in the way in which the Soda Lime is proposed to be packaged? What other suggestions could you offer?

- 1 No, I would not want changes in any way.
- 3 Yes.
- 4 I like the changes.
- 6 I think the sealed packaging is a good idea because it will make it a lot easier to start it up.
- 7 Fibreglass construction, smaller unit.
- 8 I think so. The proposed changes would make it more convenient to start and handle.
- 9 Good idea.
- 10 I see no reason to change anything.
- 11 Yes, everything is good, but there is always room for improvements.
- 12 Good!
- 13 Yes.
- 14 Yes, the changes will be O.K.
- 15 The changes are good.
- 17 All O.K.
- 19 Yes.

- 20 *Yes. Soda lime installation is no problem for handling. Put Unit on casters for moving around in refuge station.*
- 21 *Yes.*
- 22 *Good ideas. But put system on wheels.*

Other Comments and/or Suggestions:

- 2 *During your next Tommyknocker operation, they should not have any table. They should have a cot for every person.*
- 3 *Very simple to operate.*
- 5 - *For the amount of people that were inside the refuge station, I feel very confident with the RANA-AIR System. The soda lime and oxygen lasted longer than they predicted.*
- *The shell should be made of a hard plastic.*
- 7 *Could this unit be designed so that exhaust air would exit the RANA-AIR unit in such a way that the air in the refuge station would be circulating around the room? This may help relieve some of the stickiness in the air! Would it be possible to recommend to companies using this unit that circulation fans be in place or ceiling fans?*
- 8 *I am impressed with this unit and feel comfortable that I might have to depend on it some day. Thanks.*
- 11 *I was glad to participate in your tests of this unit. Thank you.*
- 12 *The blower's exits could have tubes to be fed to the extremes of the refuge station. This might create a better circulation within.*
- 17 *Carbon dioxide and oxygen monitors should be put onto the machine.*
- 18 - *This unit, in my opinion, works very well.*
- *I would like to know if we can down-size the size of the unit.*
- *Regarding the out-take of air, can you make the blower point up and out, so that we can have better circulation?*
- 20 *This test showed me that anything is possible today within the mining industry, and with equipment such as this. I know that I would feel safer working down greater depths.*
- 22 - *Very simple to operate.*
- *Maybe ceiling fans to circulate air?*
- 23 - *Participants should be shown the inside of the machine so as they can suggest if the unit could be smaller.*
- *Second drawer for the side was very tight.*
- *When soda lime was changed, air leaving the exhaust felt cooler.*
Thanks again.

mining-technology.com

CLIENT LOGIN SEARCH

- Home
- Industry Projects
- Products & Services
- Company A-Z
- White Papers
- Press Releases
- Advertise With Us
- Events & Exhibitions
- Newsletter
- New On This Site
- About Us

Home > Products & Services > Health and Safety Services and Equipment > RANA-Mining



RANA-MINING - BREATHABLE AIR UNITS AND MOBILE REFUGE CHAMBERS

RANA-Mining supplies breathable air units and mobile refuge chambers to the underground mining industry.

Experience dictates that accidents, mine fires or the sudden release of toxic or other gases can occur underground at any time and without warning. The RANA-Mining refuge chamber systems are built to protect against those occurrences. Our system consists of two units: Refuge One Air Safety Centre and the Tommyknocker mobile refuge chamber

The Refuge One Air Safety Centre is designed as a source of respirable air during an underground emergency, providing safe, breathable air in a compact, sturdy and easy to operate unit which can operate independently of mine power and compressed air.

'The Tommyknocker' portable refuge chamber is a sturdy self contained refuge chamber (station) which can be easily moved within the mine itself. It contains the Refuge One Air Safety Centre. A DC powered Air Conditioner can be purchased as an option.

BREATHABLE AIR UNIT

The Refuge One Air Safety Centre is a breathable air unit located either in a permanent refuge chamber (station) built into an underground mine, or located in a mobile refuge chamber such as our Tommyknocker model. RANA-Mining developed it 12 years ago in response to a serious mine accident in Canada, in which the compressed air and mine power were cut off from the trapped miners. RANA-Mining has sold over 70 units worldwide.

The Refuge One Air Safety Centre is a self-contained system that is designed to provide oxygen at controlled rates and to remove carbon dioxide from the air in enclosed spaces. The unit does not depend on the compressed air pipeline and does not require an external electrical source in an emergency.

The Refuge One Air Centre has been awarded the R&D Award in the USA for Significant Technology and in Canada, it received the Occupational and Safety Award of Excellence.

REFUGE ONE AIR SAFETY CENTRE



RANA-M bed Re
C
EXPA



The aw Refuge C air units in either a mobile re



RANA-M refuge c Tomn
EXPA



ATOM RSS

What is RSS?

In a sealed refuge chamber CO₂ levels can rise and O₂ levels decrease to dangerous levels. The air within the refuge station (chamber) is "processed" by the Refuge One Air Safety Centre by absorbing the CO₂ within the refuge chamber. To replenish the oxygen consumed by the occupants, oxygen from high-pressure cylinders is injected at a metered rate (dependent on the number of occupants) into the blower circuit.

When mine power is not available, the unit operates on internal long-life batteries to operate blowers. The batteries will operate the blower(s) continuously for a minimum of 36 hours. Selection of the correct model size is directly dependent on the number of people the refuge station is being designed for. Each model has a standard built-in, stored supply of soda lime and oxygen. However, the capacity in hours can be extended by providing additional kegs of soda lime and cylinders of oxygen in the refuge chamber.

The Refuge One Air Safety Centre is easy to use under stressful conditions, comes in two sizes to fit your needs, and is durable and affordable. It is a self contained system which has been tested underground by two Canadian Government agencies as a proven method of maintaining the desired environment within the refuge station.

MINING REFUGE CHAMBER – THE TOMMYKNOCKER

RANA-Mining has developed a mobile mining refuge chamber (station) known as 'The Tommyknocker'. We build, supply and service 'The Tommyknocker'. It is a sturdy self-contained unit which will sustain life for a minimum of 36 hours should miners be trapped in an underground mine without external air and power. It contains a Refuge One Air Centre.

The initial capacity of 8 to 10 people can be increased in size by increments of 4 ft. to accommodate larger numbers of people. The standard dimensions of the Tommyknocker are 7.5ft wide, 7ft high and 14ft long. It features two sealed rooms, one serving as an air lock, toilet and storage, with steel doors, sealed with freezer hatches.

This mobile unit can be connected to the mine's compressed air supply which is filtered, pressure-reduced and fitted with a noise muffler. If the compressed air is lost or unavailable then the Refuge One Air Centre will provide breathable air.

The charger has inputs of 120VAC, 60Hz and outputs of 12VDC, and other voltage and frequencies available.

RANA-Mining

72 Scurfield Boulevard

Winnipeg

Manitoba

R3Y 1G4

Canada

Tel: +1 204 928 1409

Fax: +1 204 489 1336

Email: <mailto:lyall@ranamedical.com>?

[cc=lizgarbutt@spgmedia.com&subject=enquiry from www.mining-technology.com Ref://31226](mailto:lizgarbutt@spgmedia.com&subject=enquiry from www.mining-technology.com Ref://31226)

URL: <http://www.ranamedical.com/>

 [Print friendly version](#)



Internal Tomn showing AC to t Ref
EXPA



The Tom mobile re can sus minimurr miners undergr external

CONTACT THIS COMPANY

REGIONAL OFFICES

SHAIRZAL

Shairzal Safety Engineering

Shairzal Safety Engineering (Shairzal) was formed in 1996 and manufactures pre-fabricated, portable, steel mine refuges. Information about their products was obtained from various internet sources (including their web page) and by contacting them directly. They manufacture mine refuges, fresh air bases, Airdoc coal mining change over base, and a mine escape vehicle. Shairzal also produces air scrubbers that they sell separately. Please see attached documents for additional information on these devices.

Rory Paton-Ash (President of Strata Products, a Shairzal partner for the USA) and Tony Farrugia (Managing Director, Shairzal) were asked for information about the number of Shairzal refuges sold, number and identity of any mines (coal and metal/nonmetal) where their refuges are located, instances where any refuges have been used, and requirements for maintenance of their refuge shelters. The following provides a summary of the information they provided in response to this inquiry.

Shairzal's customers include Metropolitan Fire Brigade, Bhp Billiton, Zinifex, and Rauland Australia. According to Mr. Paton-Ash, they have sold 300 steel pre-fabricated chambers and three Airdoc change over systems. The changeover systems were sold to Australian coal mines. The breakdown of their sales is as follows:

- Australia 200
- Mexico 50
- Chile 20
- Other 30

Inspections of their refuges should be performed on the following schedule:

- Monthly check of chamber for integrity/damage, pressure gauges (for no air loss), proper placement of chamber, and tamper proof seal.
- Yearly check of stored food and water.
- Five year check to replace soda lime, water and food, hydrostatic test of compressed air, and inspection of all seals.

Tony Farrugia provided information on recent incidents where Shairzal chambers were used. The following email excerpt provides a summary of their usage:

2006

1. Zinifex Limited, Tasmania, Australia - Six chambers used due to Fumes in mine for short duration havens.
2. Beaconsfield Gold Mine, Tasmania, Australia – Miners assembled in chamber prior to escape. Miners not in chamber included one miner that died and two others were trapped for 3 weeks.
3. Allegiance Mining, Tasmania, Australia - Refuge chamber used because of truck fire. The three miners in chamber were saved after 10 hours.

2005

1. Zinifex Limited, Tasmania, Australia - Refuge chambers used for a short duration because of truck fire.
2. North Parke Central Mine, New South Wales, Australia - Four refuge chambers used because of conveyor belt fire.
3. Peak Gold Mine, New South Wales, Australia – Refuge chamber used because of conveyor belt fire.

EMERGENCY REFUGE STATIONS



We build, service, repair and upgrade emergency refuge stations, fresh air bases and plant rooms.

- Mine Refuge Chambers
- Change Over Bases
- Crib Room Scrubbers
- Breathing Air Systems
- High Pressure Compressors
- 40+ Hours of Oxygen supply and Air Scrubbing Systems



Interior of unit



Air Scrubber & Oxygen System



HEAD OFFICE – 28 Jersey Rd, Bayswater, VIC 3153 PO Box 982, Bayswater, VIC AUSTRALIA 3153

Ph: +613 9720 3877

Fax: +613 9720 3529

VISIT our web site WWW.SHAIRZAL.com.au

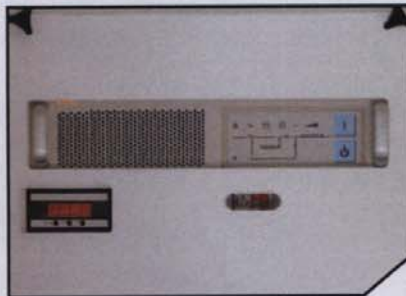

BREATHING AIR FILTRATION

Filtration is to AS1716 quality via a 4 stage filtration system. The sizing of the flow is such that the total purge of the base is done every 3 to 4 minutes. This prevents the build up of toxic gases and minimizes the heat build up. This option allows indefinite breathing air duration as long as the plant airlines are maintained.

BACK-UP AIR SUPPLY

A minimum 40hr back-up system, operated via a battery pack is installed. This unit removes toxic gases & provides breathing air for a minimum 40hrs.

AIRLOCK & ESCAPE HATCH

All Bases have a 1200 x1200 entry area just inside the door that is sectioned off via a heavy clear plastic curtain. This minimizes large quantities of contaminants entering the entire base through constant opening and closing of the door. A rear escape hatch is installed providing an alternative emergency exit.

AIR CONDITIONER

A split system air conditioning unit ensures a comfortable environment for the occupants.

STANDARD FEATURES

- Remote Controlled Reverse Cycle Air Conditioning
- 40+ Hours of Oxygen Supply and Air Scrubbing System
- Seating For All Occupants,
- Drinking Water, Fire Extinguisher
- Chemical Toilet in Separate Compartment
- Airlock On Entry - Self Closing Door with Window
- Fully Reflective Signage - 900 Candle Rating
- Custom Made Fully Welded Enclosure - Yellow/White
- Forklift Guides / Lifting Facility / Skid Base
- Primary Air Supply Source Including AS1716 Filtration
- Lighting, Overhead Shelving, First Aid Kit
- Rear Escape Hatch & Crash Barrier All Sides

OPTIONAL FEATURES

- Battery Back-up System
- IOX & Oxygen enhancement
- Base Station Communication
- I.T. & QDS attachments
- 1000V / 240V Step Down Transformer
- CO Diversion System

HANDLING

Lifting points on the top of the chamber and a forklift slots on the side. The base is a full skid allowing the unit to be dragged if needed. I.T. attachment can also be incorporated.

SIGNAGE

Highly reflective, signage identifying the Fresh Air or Refuge Base in smoke filled or restricted vision areas.

ENCLOSURE

We design and manufacture to meet specific customer needs. Sizes to cater from 4 to 40 people.

Shairzal forms the largest partnership in mine safety and purpose built equipment. Our service network is Australia wide — see below.

TOWNSVILLE SKINDIVING CENTRE - QLD

67A Railway Av, Railway Estate,
Townsville, QLD 4810
Ph: (07) 4771 5997
Fax: (07) 4771 5701

EMERGENCY MANAGEMENT SOLUTIONS - TAS

424 Hobart Rd, Youngtown, TAS 7249
Mob: 0409 367 000 Fax: (03) 6343 0347

KALGOORLIE MINING & SAFETY - WA

72 Brookman St, Kalgoorlie, WA 6430
Ph: (08) 9022 5100
Fax: (08) 9021 7083

MULTISKILLED - NSW

2/18 Oakdale Rd,
Gateshead DC NSW 2290
Ph: (02) 4908 0000
Fax: (02) 4942 4125



VISIT our web site

www.SHAIRZAL.com.au

HOME

NEWS ► SHAIRZAL EXPAND MANUFACTURING FACILITIES.

ION INSIDE MINE

AIR SCRUBBER

ABOUT US

MINING SAFETY EQUIPMENT

BREATHING AIR SYSTEMS

OTHER PRODUCTS & SERVICES

MINING SAFETY EQUIPMENT

- REFUGE CHAMBERS
- FRESH AIR BASE
- CABA CHANGE BASE
- MINE ESCAPE VEHICLE
- AIR SCRUBBER

FRESH AIR BASE

The Fresh Air Base or Change Over Base is a purpose built room made from fully welded steel to provide an airtight seal.

The entry door fitted with a self closing device, with handles (internal and external) to prevent accidental locking and a 600 x 400 window of 20 mm impact resistance poly carbonate.

Seating along both walls is constructed from a formed sheet metal main frame with a storage facility provided under the seats. Seat material is a padded high grade durable material.

Inside the entrance there is an area sectioned off, by a heavy clear strip curtain, to minimize contaminants entering the Base from constant door opening and closing. This combined with the positive pressure maintained once the unit is activated will reduce the possibility of contaminants entering the Base.

Each Fresh air base has as standard, forklift guides, skid base and lifting facility for a crane and a crash bar is fitted around the refuge to minimize damage when transported. An IT attachment can be fitted to a customer's configuration.

A high quality breathing air filter system is connected to mine air and this is fitted with a lever operated control valve.

Back up air supply is provided from air cylinders interconnected to the filter system. This maintains positive pressure during change over operations if a loss of mine compressed air occurs. The duration of breathable air is directly proportional to the number of air cylinders used.

The Base has large reflective signs fitted to all 4 sides that make it easier to find in a smoke filled environment. Directional arrows show the entrance and red and white reflective bands around the refuge also assist the unit to be located in poor visibility.

[back to the top](#)



INTERACTIVE MINE REFUGE ANIMATION



[click here to download interactive animation](#)

[ABOUT US](#) | [HISTORY](#) | [TESTIMONIALS](#) | [CONTACT US](#) | [AGENTS](#) | [NEWS](#) | [REFUGE CHAMBERS](#) | [FRESH AIR BASE](#) | [CABA CHANGE BASE](#) | [MINE ESCAPE VEHICLE](#) | [AIR SCRUBBER](#) | [RESPIRATORY EQUIPMENT](#) | [COMPRESSORS](#) | [ENGINEERING](#) | [ON SITE AIR QUALITY TESTING](#) | [BIN-GO LIFTER](#) | [LINKS](#)

Web Site designed by [Design Post](#)

Shairzal

Shairzal offers a stand alone carbon dioxide scrubber and a breathing air system for escape vehicles.. See more information on these products under "Related Equipment."

STRATA PRODUCTS

Strata Products, Inc.

Strata Products, Inc. (Strata) manufactures pre-fabricated, portable, inflatable fresh air bay and the manually erected fresh air bay. Both of these systems are sealable fabric enclosures that are deployed in the event of an emergency. Strata are also the US partner with the refuge bay and air scrubber manufacturer Shairzal (see Shairzal tab for a description of their products). Information about their products was obtained from various internet sources (including their web page) and by contacting them directly. Please see attached documents for additional information on these devices.

Rory Paton-Ash (President of Strata Products, a Shairzal partner for the USA) was contacted for information about the number of Strata refuges sold, number and identity of any mines (coal and metal/nonmetal) where their bays are located, instances where any have been used, and requirements for maintenance of their shelters. The following provides a summary of the information they provided in response to this inquiry.

They have sold 27 inflatable fresh air bays and no manually erected bays.

Inspections of their refuges should be performed on the following schedule:

- Monthly check of chamber for integrity/damage, pressure gauges (for no air loss), proper placement of chamber, and tamper proof seal.
- Yearly check of stored food and water.
- Five year check to replace soda lime, water and food, hydrostatic test of compressed air, and inspection of all tents and seals.

STRATA PRODUCTS USA

REQUEST INFO

HOME

**LIST OF PRODUCTS
AND SERVICES
AVAILABLE IN:**

UNITED STATES

EUROPE

AUSTRALIA

SOUTH AFRICA

STRATA
MINE SERVICES

NEWS & ARTICLES

We support you below and above ground.

Strata Products (USA) Inc. primarily services the underground coal markets in the USA. However, we also market to other underground operations such as Trona and limestone operations.

Our primary manufacturing operation and distribution facility is based in Sutton, West Virginia. Sixty percent of the underground coal mines in the USA are within a 150 mile radius of this facility.

We also have warehouse facilities in Alabama, Illinois and in Colorado.

The key to our success is locally based sales engineers who understand the conditions and operating environment of the local mines.

In addition, Strata Mine Services provides turnkey installation and logistics so that we can provide the full range of services.

Our engineers can evaluate your roof control conditions and recommend a range of solutions from our wide range of products.

SAFETY PRODUCTS *NEW!

- Portable Fresh Air Bay
- The Emergency Refuge Station
- AIRDOC Change Over Station
- Carbon Dioxide Scrubber System
- ExtendAir® CO2 Absorbent Curtains

PROP TYPE SUPPORT SYSTEMS

- Propsetter Yieldable Support System (View Adobe pdf)
- Rocprop (View Adobe pdf)
- Cluster Prop (View Adobe pdf)
- Sand Prop (View Adobe pdf)
- Bolt Prop (View Adobe pdf)



- Lock-N-Load (View Adobe pdf)
- Duke Prop

TIMBER CRIBS and OTHER SUPPORT SYSTEMS

- Hercules Mats (View Adobe pdf)
- Link-N-Lock (View Adobe pdf)
- Mesh Pack Pumpable Cribs (View Adobe pdf)

COATINGS AND LINERS

- Thin Support liners (View Adobe pdf)
 - Castonite (View Adobe pdf)
 - Tunnel Guard (View Adobe pdf)

POLYMERS

- Rocsil® Foam
- Marithan®

PUMPS and PRE-STRESSING DEVICES

- Hand Grout Pumps (View Adobe pdf)
- Pre-Stressing Bags (View Adobe pdf)
- Power Wedge (View Adobe pdf)
- Hydrocell

SEAL SYSTEMS

- Seals: Pre-Loaded (View Adobe pdf)
- Seals: Pumpable

SERVICES AVAILABLE IN THE USA

- Concrete and Grout Pumping Services
- Underground Installation Services

Strata Products Home | USA | United Kingdom | Australia | South Africa | Strata Mine Service
News & Articles | Contact Us

STRATA PRODUCTS USA

REQUEST INFO

HOME

**LIST OF PRODUCTS
AND SERVICES
AVAILABLE IN:**

UNITED STATES

EUROPE

AUSTRALIA

SOUTH AFRICA

STRATA
MINE SERVICES

NEWS & ARTICLES

Emergency Refuge Stations

- The Emergency Refuge Station is a steel constructed refuge chamber equipped with a Shairzal breathing air system to provide an area of fresh, breathing air, free of hazardous gases and smoke
- They also serve as a storage area for life preserving supplies such as food and water
- The stations are available in standard sizes and can be custom built according to customer's individual needs. This includes custom lengths and heights of the stations
- Primary operation includes attaching to the mines main airlines and power to provide an indefinite supply of air and power
- A specialized filtration system performs a complete cleansing of the air in the chamber every 3 to 4 hours. This prevents CO₂ and heat build up
- If mine air is not available, stations are equipped with a standard 48 hour battery back-up supply system which includes medical grade oxygen cylinders and a CO₂ Scrubber amount of supplies for the breathing air system is fully scalable. ([More information on CO₂ Scrubber](#))
- If mine power is lost or not available, the Emergency Refuge Stations have a battery back-up power system. This runs the lights, the AC and the CO₂ Scrubber. When battery power is depleted, the lighting system and the CO₂ Scrubber have built-in 36 hour battery
- The entry is separated from the main compartment by a heavy plastic curtain called an Air-lock entry. The purpose of the curtain is to minimize contamination of the main chamber when the door is opened
- Air-Conditioning units are standard and these regulate the interior temperature
- The inside of the Stations are equipped to ensure the safety and comfort of occupants



- Numerous handling accessories are built into the structure to assist with the relocating of the stations

KEY FEATURES

- 48 hour back-up air supply that is fully scalable
- 36 hour back-up power supply that is fully scalable
- Remote control, reverse cycle air conditioner to maintain a comfortable environment
- 12 volt lighting system
- Drinking water and food
- Chemical toilet in a separate compartment
- Durable, cushioned seating for all occupants
- Storage areas
- Forklift guides, lifting facility and skid base

SAFETY FEATURES

- Back-up air supply system
- Back-up power supply system
- 4-Gas monitoring system
- Escape hatch
- Airlock entry to minimize contaminants entering the station
- Self closing door
- Fire extinguisher
- Fully reflective signage for greater visibility



Interior of Station showing curtain



Battery Back-up



Air Conditioning unit



Escape hatch



Mine Air Filter System

STANDARD SIZES

Size	Length	Width	Height
20 man	20 ft	7 ft	7 ft

15 man	16.5 ft	7 ft	7 ft
10 man	13 ft	7 ft	7 ft
8 man	12 ft	7 ft	7 ft

[Download Adobe pdf file of the Emergency Refuge Station product sheet.](#)

Please read about the [Fresh Air Bay](#) and the [AIRDOC Change Over Station](#), other options to Emergency Refuge.

[Strata Products USA Home](#) | [Strata Mine Services](#) | [Request More Information](#) | [News & Articles](#)
[Fresh Air Bay](#) | [Emergency Refuge Station](#) | [Scrubber System](#) | [AIRDOC](#) | [Propsetter Yieldable Support](#)
[System](#) | [Sand Prop](#) | [Bolt Prop](#) | [Cluster Prop](#) | [Rocprop](#) | [Duke Prop](#) |
[Lock-N-Load](#) | [Hercules Mats](#) | [Link-N-Lock](#) | [Thin Support Liners](#) | [Castonite](#)
[Tunnel Guard](#) | [Rocsil Foam](#) | [Marithan](#) | [Hand Grout Pumps](#) | [Pre-Stressing Bags](#) | [Power Wedge](#) |
[MeshPacks](#) | [Seals: Pre-Loaded](#) | [Concrete and Grout Pumping Services](#) | [Underground Installation](#)

STRATA PRODUCTS USA

REQUEST INFO

HOME

LIST OF PRODUCTS
AND SERVICES
AVAILABLE IN:

UNITED STATES

EUROPE

AUSTRALIA

SOUTH AFRICA

STRATA
MINE SERVICES

NEWS & ARTICLES

Portable Fresh Air Bay
Portable Inflatable Refuge Chamber

- The Fresh Air Bay is a portable, inflatable refuge chamber that provides a fast place of refuge for miners when hazardous gases, smoke or poor ventilation impose a threat to human life
- The Fresh Air Bay folds up and stows away when not in use
- It is stowed on a specially designed skid, along with all components and acc easily moved along with products and to remote locations
- In the event of an emergency, the Air Bay is quickly inflated using compressed

**Breathable Air and Oxygen Bottles**

- The Fresh Air bay operates using compressed air and oxygen cylinder. Scrubbing system
- Strata Products has designed a specialized metal skid that houses and Air bay, all the compressed air and oxygen cylinders, the CO₂ scrubbing water, gas monitors and the cooling system together.
- In an emergency, the miners locate the skid and open the valves on the cylinders to inflate the Bay
- Once inside the Bay, the miners can regulate the oxygen flow rates using a meter
- The patent pending, Shairzal 48 Powerless CO₂ Scrubbing System uses chemicals and compressed air cylinders to scrub the CO₂ out of the air and monitors CO₂ levels.
- Powerless cooling systems are also available to control the temperature
- Standard air supplies last 48 hrs. These amounts are scalable up or down
- All units are designed with two chambers; the Air-Lock Entry chamber and the main chamber. When the Bay is already occupied, the Air-Lock entry allows miners to enter the Bay without deflating or jeopardizing the quality of the air in the main chamber

- The material from which the Air Bays are constructed is durable, robust and fire retardant. The edges are welded to be air tight and the high quality construction is intended for long term use and re-use
- The Fresh Air Bays are constructed to different sizes and local manufacturers are established to ensure speedy delivery
- Food, water, a first aid kit and a location light are stored in the skid at the front of the Bay

KEY BENEFITS

- Provides a breathable air in emergency situations
- Operable with compressed air and oxygen cylinders
- Fast and simple to use
- Self contained, portable and re-usable
- Entire unit inflates in minutes
- No assembly or extra parts required



Interior view of 1

SAFETY FEATURES

- Air-lock Entry separate from Main chamber to protect the integrity of the Main chamber
- Reflective strips and operating instructions clearly visible on the interior
- Food and water available
- 4-gas Monitoring system
- Document holder to keep plans of the area

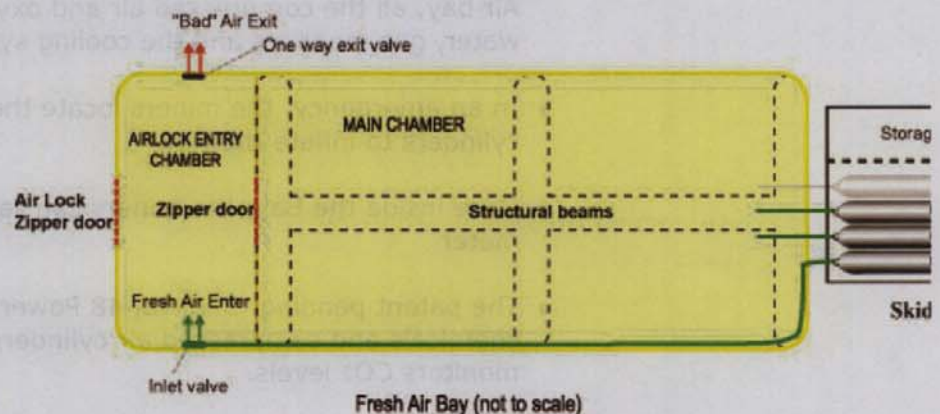



Unfolding Air Bay before inflating



**Miners can sit and breathe nor
inside the Air Bay**

[Download Adobe pdf file of the Fresh Air Bay product sheet.](#)

Please read about our [Emergency Refuge Stations](#) and the [AIRDOC Change Over Station](#)

[Strata Products USA Home](#) | [Strata Mine Services](#) | [Request MoreInformation](#) | [New:](#)
[Fresh Air Bay](#) | [Emergency Refuge Station](#) | [Scrubber System](#) | [AIRDOC](#) | [Propsetter Yeldable Supp](#)
[Bolt Prop](#) | [Cluster Prop](#) | [Rocprop](#) | [Duke Prop](#) |
[Lock-N-Load](#) | [Hercules Mats](#) | [Link-N-Lock](#) | [Thin Support Liners](#) | [Castonit](#)
[Tunnel Guard](#) | [Rocsil Foam](#) | [Marithan](#) | [Hand Grout Pumps](#) | [Pre-Stressing Bags](#) | [Power Wedge](#) |
[Seals: Pre-Loaded](#) | [Concrete and Grout Pumping Services](#) | [Underground Installatio](#)

Submission by Rory Paton-Ash, President of Strata Products (USA) Inc., Marietta Georgia

RIN 1219-AB44

A. Rapid Deployment Systems

The Portable Fresh Air Bay can be used in the event of an emergency underground. Because of its portability, the Fresh Air Bay can be deployed within a safe distance from an accident/incident site and used in the following circumstances:

- As a temporary fresh air bay underground to allow Rescue teams to rest and recover. Team members can remove breathing apparatus, rest, discuss the situation and drink water and eat as necessary without having to go all the way outside of the mine. This technique is used in mines rescue work in South Africa.

- To stabilize an injured worker who may be having difficulty using breathing apparatus or a SCSR.

Description of the Strata Products Portable Fresh Air Bay.

I. Strata Products Portable Fresh Air Bay

The Portable Fresh Air Bay is an inflatable refuge chamber that can be folded up and moved around to different locations in the mine. In the event of an emergency, the Fresh Air Bay can be inflated in minutes and the miners can remain in the chamber breathing normally.

- Can be inflated using compressed mine air or breathable air bottles
 - Compressed air:
 - Specialized filters installed to purify compressed mine air.
 - Air continuously flows through the chamber and out through exit air valves
 - Breathable Air and Oxygen Bottles:
 - Bottles are located outside the chamber.
 - The valve is opened to inflate the chamber.
 - An Oxygen Flow Meter inside the chamber allows miners to regulate oxygen flow into the chamber from inside the unit.
 - Wasted gas escapes through door zipper and relief valve
 - CO2 Absorbent Curtains or the Powerless Scrubber System can be used in conjunction to scrub the CO2 out of the air
 - A CO2 metering device included to monitor CO2 levels
 - Other optional accessories:
 - A chemical toilet in a separate compartment

Submission by Rory Paton-Ash, President of Strata Products (USA) Inc., Marietta Georgia

- Drinking water for all occupants
- Food for all occupants
- Standard time the system is designed to function as a refuge is 48 hours. This is scalable up or down
- All equipment is loaded on a movable skid to allow rapid and easy movement inside a underground mine environment.

D. Rescue Chambers

General Comment

A distinction needs to be made between rescue chambers and a change over station. A change over station can be placed in various parts of the mine to facilitate the safe change over from one system to another. There is significant risk when a miner has to change from one SCSR to another. This can be safety achieved in a Change over station that is equipped with breathable air systems. The station is a simple, inexpensive structure that can assist and facilitate the evacuation plan in the event of an emergency.

A change over station can be equipped with scrubbing systems and breathable air controls that are activated in the event of an emergency.

1. Should Rescue Chambers be required?

Cost effective options are available to provide a refuge in the event miners cannot self escape for a mine. These chambers provide an alternative option to self escape and allow rescue teams to reach these designated points and achieve the orderly evacuation of miners after an incident. If miners are injured, chambers offer an alternative and attractive option to allow time for rescue teams to stabilize the injured worker and then effectively evacuate the injured worker from the refuge station.

2. Characteristics of Chambers

Products and technology are available to allow mine operators to make informed decisions as to what they require. As mining operations move so quickly, a combination of permanent and portable stations seems feasible to provide the mine with a plan to allow the safe evacuation in the event of an emergency.

Simple change over stations can facilitate the orderly evacuation of the mine and these stations can be built in or mobile. Given the known limitations of SCSR's the mine can then place change over or refuge chambers at locations that are accessible and within reasonable walking distances from the current working environment or on the primary means of egress from the mine.

Submission by Rory Paton-Ash, President of Strata Products (USA) Inc., Marietta Georgia

If possible, permanent stations should be connected to mine air or outside air sources and these systems need to be backed up and be shall be able to work without any power source. These systems are available at present. Simplicity and ease of operations needs to be the hallmark of these systems that require a minimal amount of training and that can be operated by following simple instructions.

Mine operators should be given the leeway to generate plans that suit the environment that they operate in as is the case with other operating plans (such as support and ventilation) that they currently submit to State and Federal authorities for approval.

3. How long should they support breathable air

This needs to be determined on a mine by mine basis based on the mine plan. Evacuation routes, depth, alternative access and number of entries. It however seems reasonable that a minimum standard should be established so that miners who have to make the choice of using a chamber know that they have at least a certain amount of time in the chamber before they can reasonably expect to be rescued. It is possible to scale the amount of breathable air available without dramatically increasing the cost of the chamber. Adding additional scrubbing materials and oxygen bottles is relatively inexpensive to provide additional time to allow rescue teams to reach these sites. Most counties that specify chambers require a minimum of 36 hours of breathable air.

Prolonged use of a chamber will cause significant discomfort and so health and safety, and sanitation issues need to be addressed the longer the anticipated period of occupation of the chamber.

4. Number of people

Chambers for up to 30 people are available on the market. This needs to determined on a mine by mine basis based on the safety and emergency evacuation plan that the mine should submit.

5. Number of Chambers

As self rescue should be the primary evacuation plan, the mine plan should be based on a reasonable assessment of the risks at each mine. The Safety Officer or mine management should submit a plan that deals with the evacuation plan/rescue plan in the event of an emergency and should deal with the likelihood of miners being trapped. The number of chambers should then be based on that assessment as well as the distance to the outside of the mine as "change over" stations may be required to achieve an orderly evacuation of a mine!

Submission by Rory Paton-Ash, President of Strata Products (USA) Inc., Marietta Georgia

J. Government Rule

1. Equipment and technology for mines rescue

RIN 1219-AB44,

**Underground Mine Rescue Equipment Technology, Supplementary Information:
III Key Issues**

D. Rescue Chambers

Strata Products (USA) Inc. has taken action to find solutions to increase underground safety because we are concerned about the physical and financial health of miners and mining companies. We understand the economics of small mines and are working to provide a cost effective alternative to the originally proposed SCSR system.

Strata Products (USA) Inc. is now providing the following:

1. Strata Products Portable Fresh Air Bay

The Portable Fresh Air Bay is an inflatable refuge chamber that can be folded up and moved around to different locations in the mine. In the event of an emergency, the Fresh Air Bay can be inflated in minutes and the miners can remain in the chamber breathing normally.

- Can be inflated using compressed mine air or breathable air bottles
 - Compressed air:
 - Specialized filters installed to purify compressed mine air.
 - Air continuously flows through the chamber and out through exit air valves
 - Breathable Air and Oxygen Bottles:
 - Bottles are located outside the chamber.
 - The valve is opened to inflate the chamber.
 - An Oxygen Flow Meter inside the chamber allows miners to regulate oxygen flow into the chamber from inside the unit.
 - Wasted gas escapes through door zipper and relief valve
 - CO2 Absorbent Curtains or the Powerless Scrubber System can be used in conjunction to scrub the CO2 out of the air
 - A CO2 metering device included to monitor CO2 levels
 - Other optional accessories:
 - A chemical toilet in a separate compartment
 - Drinking water for all occupants
 - Food for all occupants
- Standard time the system is designed to function as a refuge is 48 hours. This is scalable up or down

Submission by Rory Paton-Ash, President of Strata Products (USA) Inc., Marietta Georgia

2. ExtendAir® CO2 Absorbent Curtain

The ExtendAir® Lithium Hydroxide curtain is a passive CO2 absorbent intended for use in enclosed areas. When hung with all sides exposed it quickly and effectively absorbs the CO2 out of the air. These units require no electrical power.

- Packed in rigid ammo box with eight (8) curtains per box
- Packages in sets of two in a soft foil protective inner pouch
- Uses LiOH (Lithium Hydroxide) to scrub the CO2 out of the air. .794 lb CO2/lb LiOH
- Utilizes the same technology approved by the US Navy for 7-day emergency atmospheric control on submarines
- Used in conjunction with Oxygen bottles for the Fresh Air Bay rescue system
- Depending on number of occupants, a set number of curtains are hung upon entrance into the chamber. At 12 hour intervals, additional curtains are added.

3. Emergency Refuge Station

The Shairzal® Emergency Refuge Station is a purpose built, steel constructed safety chamber for miners to seek refuge in the event of hazardous gases, toxic smoke, poor ventilation and depleting oxygen levels imposes a threat to human life.

- Size:
 - Standard sizes are: 7' W x 20' L x 7' H
7' W x 16.5' L x 7' H
7' W x 13' L x 7' H
7' W x 12' L x 7' H
 - Customized sizes to any specifications customers and mines require.
- Can be used with compressed mine air or oxygen bottles and a CO2 scrubber
 - Compressed Mine Air:
 - Indefinite supply of fresh breathing air
 - Air flows through filtration system before entering chamber
 - Oxygen bottles and CO2 scrubber
 - Stand alone CO2 scrubber system attaches to oxygen bottles that release oxygen at controlled rates
 - Utilizes soda lime chemicals to scrub the CO2 out of the air.
 - Standard equipped with 48 hours supply of oxygen and soda lime. This is scalable up or down
- Chambers are powered by the mines main power source or battery back-up system
 - Mine power:
 - Indefinite supply of electrical power

Submission by Rory Paton-Ash, President of Strata Products (USA) Inc., Marietta Georgia

- Battery back-up:
 - 36 hours of battery back-up power supply
 - Power all electrical equipment
- Electrical equipment:
 - 12 volt lighting
 - Air conditioning unit
 - CO2 scrubber system
- Air Conditioning
 - Regulates internal temperature
 - Temperatures setting range between 77° F & 86°F
 - Will shut off when battery back-up is exhausted
- Safety Features:
 - Self closing door
 - Impact resistant window
 - Entrance area with heavy clear strip curtain to minimize contaminants entering main chamber
 - Fire extinguisher
 - External location lights and warning siren
 - Rear escape hatch which opens inward
- Other accessories:
 - Drinking water for all occupants
 - First Air Kit
 - Chemical toilet in separate compartment
 - Storage areas
 - Forklift guides, lifting facility and skid base for easy relocation
- Powerless chamber option
 - Chambers can be provided without electrical power, air conditioning or lights
 - These can be used as a "change over/refreshers" unit for miners as they work to exit the mines
 - Powerless Scrubber System is available to provide fresh breathing air while occupants are in the station

4. Stand alone carbon dioxide scrubbing system

This self contained system is designed to provide oxygen at controlled rates and remove carbon dioxide from the air in enclosed areas

- Provides 48 hours of breathable air using oxygen bottles and CO2 scrubber system. System is required to be turned on in the event that no compressed mine air is available.
 - Oxygen:
 - Attaches to G-size oxygen bottles
 - A Flow Meter valve controls the amount of oxygen being fed into the chamber
 - This is set according to the number of occupants

Submission by Rory Paton-Ash, President of Strata Products (USA) Inc., Marietta Georgia

- Clear instructions are available on or near the unit
- CO2 Scrubbing:
 - A unit 3-fan design draws the wasted air into the unit and forces it through a tray of soda lime chemicals.
 - Soda lime scrubs the CO2 out of the air
 - The color of the soda lime will change when it is no long effective
 - Replacement chemicals are stored in the chamber
 - The length of time the soda lime will last depends on the number of occupants
 - Operating instructions are located on the front of the scrubber

5. Powerless Scrubbing System

This is a patented design for providing breathable air. It consists of an oxygen bottle and compressed breathable air that induces movement of the air through a bed of soda lime which scrubs the CO2 out of the breathed air. No power is required as the energy is provided by the flow of air through the system.

6. Equipment into Mine rooms

Scrubbing systems, such the Extend Air Lithium Hydroxide Curtains or the Shairzal 48 hour powered or powerless scrubber can be installed in a mine room or evacuation. These need to be combined with Medical grade oxygen that can be metered in to the room at a certain rate depending on the number of occupants in the room. These products and systems are available from Strata Products (USA) Inc.

Contact information

Email: rpatonash@strataproducts.com

Telephone: 770-321-2501

Fax: 770-321-2526

Submission by Rory Paton-Ash, President of Strata Products (USA) Inc., Marietta
Georgia

Strata

Strata offers an AIRDOC, a carbon dioxide scrubber and the ExtendAir® CO₂ Absorbent Curtain. See more information on these products under "Related Equipment."

RELATED EQUIPMENT

MINE REFUGE MANUFACTURERS
31 NOVEMBER 2006

Manufacturer	Product Name	Contact Information	Refuge Type	Construction	Dimensions	Features	Additional Information
RELATED EQUIPMENT ChemBio	MRE		Self-contained operational rations	Flexible meal packed in a flexible meal bag.	Twenty-four different varieties of meals	The contents of one MRE meal bag provides an average of 1250 kilocalories (13% protein, 36% fat, and 51% carbohydrates). It also provides 1/3 of the Military Recommended Daily Allowance of vitamins and minerals determined essential by the surgeon General of the United States.	
Molecular Products LTD	PACU (Portable Atmosphere Control Unit)	Mill End, Thaxted, Essex, CM6 2LT, United Kingdom Tel: +44 (0) 1371 830676 Fax: +44 (0) 1371 830998 http://www.molecularproducts.co.uk/				CO ₂ absorber, O ₂ generator. Supports 4 people for 24 hours in a 32 m ³ space.	
Molecular Products LTD	CASPA (Carbon dioxide Self Powered Adsorber)						
Molecular Products LTD	SCOG (Self Contained Oxygen Generator)					Raises O ₂ content in a 24 m ³ space from 18-21%. 720 litres of O ₂ over 25 minutes.	
Shairzal	Carbon Dioxide Scrubber		Stand Alone Fit In			The Refresh 48 is a self contained system that is designed to provide oxygen at controlled rates and to remove carbon dioxide from air in an enclosed or confined space. Powered by 240 Volt and has an inbuilt battery backup. It can run for a 48 hour period without main power connected.	

MINE REFUGE MANUFACTURERS
31 NOVEMBER 2006

Manufacturer	Product Name	Contact Information	Refuge Type	Construction	Dimensions	Features	Additional Information
Shairzal	Breathing Air System for Escape Vehicles		Fitted into any vehicle	Customizable		Custom made options to suit any vehicle. Variable duration depending on vehicle type & configuration., supplied in kit form and transferable between vehicles.	
Strata	AIRDOC	3939 Roswell Rd., Ste. 100, Marietta, GA 30062, USA Tel: 1-800-691-6601 Fax: 770-321-2520 www.strataproducts.com	Change over station	Welded Steel	The AIRDOC is a transitional unit and is designed for walk through	The first level of safety is a filtration system that is connected to mine air. While Mine air is available and turned to the "ON" position, the duration of air supply is virtually unlimited. As a secondary level, the AIRDOC has a powerless breathing air system which provides breathable air using compressed oxygen cylinders and a CO ₂ scrubbing system. Oxygen from cylinders is directed through the Carbon Dioxide Scrubber and released into the center of the change over area of the AIRDOC. When operating on 100% stand alone mode, the AIRDOC provides 9 hours of breathable air. Food, water communication devices, extra SCSRs and first aid kits can be stored in the units. Fitted with a storage rack that holds 50 self rescuers.	
Strata	Carbon Dioxide Scrubber		Self contained system	Welded steel	36" wide x 16" deep x 39" high, 154 lbs.	Self contained system designed to provide oxygen at controlled rates and remove carbon dioxide from the air in enclosed areas. It utilizes H-size oxygen cylinders and soda lime chemicals. System is electrically powered and has a 36 hour built in battery back-up if main power is lost.	Powerless CO ₂ scrubbing system that requires no electrical power to run. Utilizes only compressed air cylinders and soda lime chemicals to scrub the CO ₂ out of the air.
Strata	ExtendAir® CO ₂ Absorbent Curtain			Lithium Hydroxide curtain		Fast and easy deployment with no tools or electrical power required. Begin working immediately, tested performance, currently used by the US Navy. Packaged in US Mil-B-131H soft foil inner pouches and rigid ammo box outer boxes.	

ChemBio Shelter Inc.

Allentown, Pa

1-800-344-6275

WHAT IS IT?

The MRE is a totally self-contained operational ration consisting of a full meal packed in a flexible meal bag. The full bag is lightweight and fits easily into clothing pockets. Each meal bag contains an entree and a variety of other components as may be seen in the table of Menus. For the current production year, menus 1 - 12 are designated case A, and menus 13 - 24 are designated case B. The net weight per case is approximately 22 lbs. and 1.02 cubic feet.

WHAT IS IN IT?

The twenty-four different varieties of meals can be seen in the menu table. Components are selected to complement each entrée as well as provide necessary nutrition. The components vary among menus and include both Mexican and white rice, fruits, bakery items, crackers, spreads, beverages, snacks, candy, hot sauce, and chow mein noodles for the pork chow mein entrée. The fruits may be applesauce, pears, peaches, pineapple, or strawberry. The bakery items include a fudge brownie, cookies, fruit bars, a toaster pastry, and pound cake in flavors of lemon, vanilla, orange, pineapple, and chocolate mint. Each meal also contains an accessory packet. The contents of one MRE meal bag provides an average of 1250 kilocalories (13 % protein, 36 % fat, and 51 % carbohydrates). It also provides 1/3 of the Military Recommended Daily Allowance of vitamins and minerals determined essential by the Surgeon General of the United States.

HOW DO I EAT IT?

Except for the beverages, the entire meal is ready to eat. The entree may be eaten cold

HOW LONG WILL IT LAST?

The shelf life of the MRE is three (3) years at 80 degrees F. However, the shelf life can be extended through the use of cold storage facilities prior to distribution.

MRE XXIII MENUS:*

MENU 1	MENU 2	MENU 3	MENU 4	MENU 5
Beefsteak w/ Mushrooms	Pork Rib**	Beef Ravioli	Country Captain Chicken	Chicken Breast
Western Beans	Clam Chowder	Potato Sticks	Buttered Noodles	Minestrone Stew
Jelly	Cheese Spread	Cheese Spread	Cheese Spread	Cheese Spread (Jalapeno)
Crackers	Wheat Snack Bread (2)	Crackers	Crackers	Wheat Snack Bread
Beef Snack		Fudge Brownie	Toaster Pastry	Pound Cake
			Candy***	Candy***
Dairy Shake	Beverage Base, Powdered	Beverage Base, Powdered	Mocha Cappuccino	
	Hot Sauce	Hot Sauce	Hot Sauce	
Accessory Packet, B	Accessory Packet, A	Accessory Packet, A	Accessory Packet, A	Accessory Packet, D
Spoon	Spoon	Spoon	Spoon	Spoon

MENU 6	MENU 7	MENU 8	MENU 9	MENU 10
Chicken w/Thai Sauce	Chicken w/Salsa	Beef Patty	Beef Stew	Chili and Macaroni
Yellow/Wild Rice Pilaf	Mexican Rice	Nacho Cheese Pretzels		
	Shortbread Cookie	Beef Strip		Chocolate Mint Cookie
Peanut Butter	Cheese Spread (Jalapeno)	Cheese Spread	Jelly	Cheese Spread (Jalapeno)
Crackers (Vegetable)	Crackers (Vegetable)	Wheat Snack Bread (2)	Crackers	Wheat Snack Bread
Raisin Nut Mix	Candy***	BBQ Sauce	Chocolate Disk Cookie	
Fruit Vanilla Cappuccino		Beverage Base, Powdered	Dairy Shake	Cocoa Beverage Powder
Hot Sauce	Hot Sauce	Hot Sauce	Hot Sauce	
Accessory Packet, E	Accessory Packet, C	Accessory Packet, C	Accessory Packet, A	Accessory Packet, B
Spoon	Spoon	Spoon	Spoon	Spoon

MENU 11	MENU 12	MENU 13	MENU 14	MENU 15
Pasta w/Vegetables in Tomato Sauce	Black Bean & Rice Burrito	Cheese Tortellini	Manicotti w/Vegetables**	Beef Enchiladas

Hard Candy	Hard Candy	Pound Cake	Pound Cake	Mexican Rice
Pound Cake	Fudge Brownie	Hard Candy	Salted, Dry Roasted Peanuts	Chocolate Chip Cookies
Applesauce	Wet Pack Fruit	Applesauce	Wet Pack Fruit	Beverage Base, Powdered
Peanut Butter	Peanut Butter	Peanut Butter	Peanut Butter	Cheese Spread (Jalapeno)
Crackers	Crackers	Crackers	Crackers	Crackers (Vegetable)
	Picante Sauce			Hot Sauce
Accessory Packet, D	Accessory Packet, D	Accessory Packet, D	Accessory Packet, D	Accessory Packet, A
Spoon	Spoon	Spoon	Spoon	Spoon

MENU 16	MENU 17	MENU 18	MENU 19	MENU 20
Chicken w/Noodles	Beef Teriyaki	Turkey Breast w/Gravy & Potatoes	Roast Beef**	Spaghetti w/Meat Sauce
Raspberry Applesauce	Chow Mein Noodles	Chocolate Sports Bar	Spiced Apple Slices	
Cheese Spread	Jam	Peanut Butter	Cheese Spread	Cheese Spread
Crackers (Vegetable)	Shortbread Cookie	Crackers	Crackers	Wheat Snack Bread
Candy***	Candy***			Hard Candy
Fig Bar	Wheat Snack Bread	Cheddar Cheese Pretzels	Oatmeal Cookie	Wheat Snack Bread
Cocoa Beverage Powder	Beverage Base, Powdered	Beverage Base, Powdered	Cocoa Beverage Powder	Dairy Shake
Hot Sauce	Hot Sauce	Hot Sauce	Hot Sauce	Hot Sauce
Accessory Packet, A	Accessory Packet, E	Accessory Packet, A	Accessory Packet, A	Accessory Packet, A
Spoon	Spoon	Spoon	Spoon	Spoon

MENU 21	MENU 22	MENU 23	MENU 24
Chicken Tetrizzini	Jambalaya	Chicken w/Cavatelli	Meat Loaf w/Gravy
	Candy***	Pretzels	Mashed Potato
Chocolate Covered Oatmeal Cookie	Pound Cake	Pound Cake	Vanilla Wafer Cookie
Crackers	Cheese Spread (Jalapeno)	Peanut Butter	Jelly
Jam	Wheat Snack Bread	Wheat Snack Bread	Crackers
Dairy Shake	Beverage Base, Powdered	Beverage Base, Powdered	Cocoa Beverage Powder
	Hot Sauce	Hot Sauce	
Accessory Packet, B	Accessory Packet, A	Accessory Packet, A	Accessory Packet, B
Spoon	Spoon	Spoon	Spoon

*MRE XXIII Menus are the most recently formulated menus. Please note that availability to the "end user" is dependent upon distribution and exhaustion of current menu stock.

**New MRE XXIII entree item.

***Chocolate disks, fruit-flavored disks, Chocolate disks with crisped rice or Chocolate disks with peanut butter.

ACCESSORY PACKET COMPONENTS:

	A	B	C	D	E
Tea, Instant w/Sweetener & Lemon Flavor			X	X	
Coffee	X	X			
Sugar	X	X			X
Creamer	X	X			X
Salt	X	X	X	X	X
Chewing Gum	X	X	X	X	X
Matches	X	X	X	X	X
Toilet Tissue	X	X	X	X	X
Hand Cleaner	X	X	X	X	X
Apple Cider				X	
Red Pepper		X			
Seasoning Blend, Salt Free				X	
Candy, Vanilla Caramels or Chocolate		X			
Tea Bag					X

MOLECULAR PRODUCTS LTD



molecular

pure inspiration

COMPETENCIES



molecular



pure inspiration

MOLECULAR PRODUCTS

Capabilities - Gas Filtration



Respiratory



Industrial



Military



Environmental

pure inspiration



molecular

MOLECULAR PRODUCTS

Capabilities - O₂ Generation



Military



Healthcare



Respiratory



Aerospace *pure inspiration*



molecular

MOLECULAR PRODUCTS

Capabilities - CO₂ Removal



Military



Healthcare



Industrial



Offshore pure inspiration

COLLECTIVE PROTECTION IN SEALED ENVIRONMENTS



molecular

Applications

- Mine refuges in hard rock mining
- Safe havens for chemical or gas production facilities
- Military and civilian bunkers

Customers

- Shelter designers and builders
- Shelter operators

pure inspiration

COLLECTIVE PROTECTION IN SEALED ENVIRONMENTS



molecular

Mine Refuge

- Sealed environment
- Totally independent air supply and toxic gas removal



pure inspiration

PACU



molecular

- **P**ortable **A**tmosphere **C**ontrol **U**nit
- The PACU combines CO₂ absorption (product known as CASPA, packed with Sofnolime) and O₂ generation (product known as SCOG, packed with a chlorate candle)
- Current design specified for 4 people for 24 hours in a sealed room approx 32 m³



pure inspiration



molecular



CO₂ free air with
O₂ replenished

Air with elevated
CO₂ &
decreased O₂
from
atmosphere

pure inspiration

CASPA Capability

- **C**arbon dioxide **S**elf **P**owered **A**bsorber
- Self contained absorption unit intended for removal of respired CO₂ in an enclosed environment
- CO₂ capacity of unit > 1600 litre per unit
- Operational envelope
 - » 1-3% CO₂ at 5-30°C and up to 5 bar
- Storage life – 10 years
- Each unit is capable of removing the CO₂ produced by 4 people in a 12 hour period



molecular



pure inspiration

Internal location of CASPAs

CO₂ free air



molecular



CASPA contains
7kgs Sofnolime to
absorb CO₂

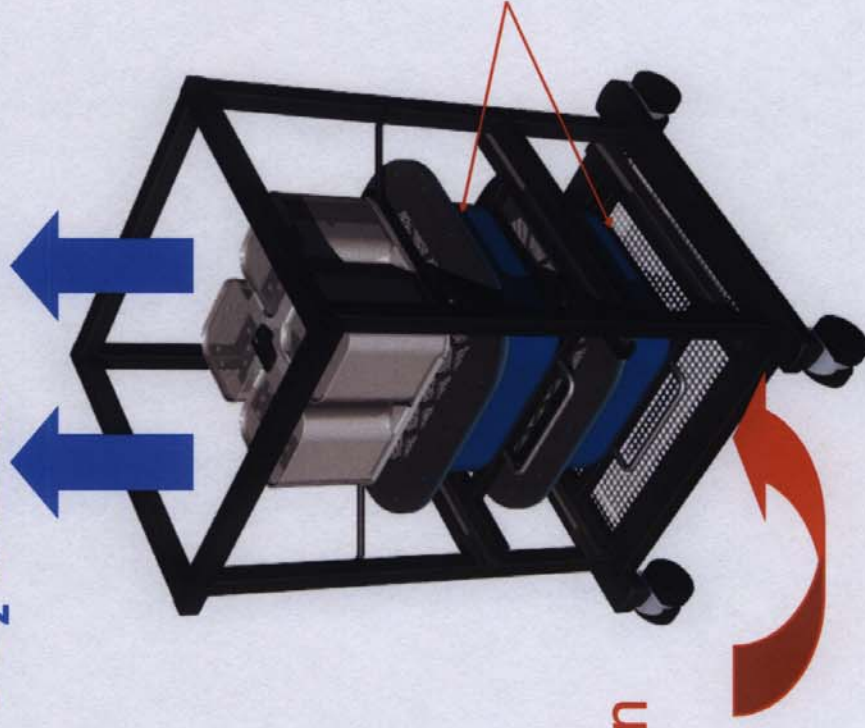

CO₂ laden
air in

pure inspiration

SCOG Capability

- **Self Contained Oxygen Generator**
- Intended to produce breathable oxygen
- Operational performance unaffected by external temperatures and pressures
- 720 litres of O₂ over 25 minutes
 - » This will raise the O₂ content in a room of 24m³ from 18-21%



molecular



pure inspiration

Internal location of SCOGs

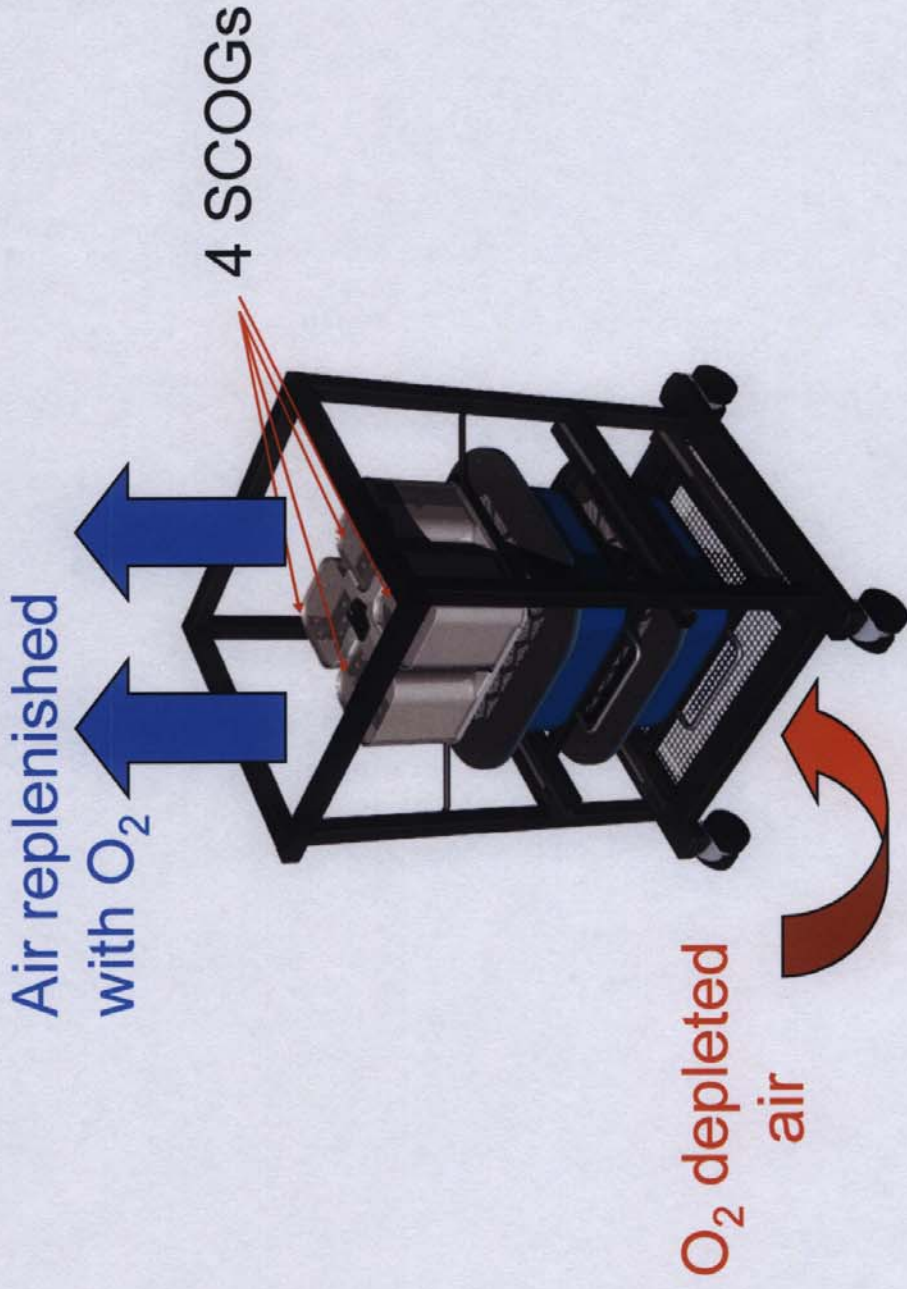

molecular

pure inspiration



molecular

The unit is
designed for 4
people for 24
hours in a 32 m³
sealed room



The consumables
can be replaced to
extend running time

pure inspiration

O₂ generator initiated when O₂ drops below set value



CO₂ absorber initiated when CO₂ rises to set value

PACU Portable Atmosphere Control Unit

molecular



pure inspiration

REFUGE·ONE

AIR CENTRE



KEY FEATURES

- Removes Carbon Dioxide and replenishes Oxygen to maintain breathable air
- Does not require any compressed air or connection to surface
- Works independently of mine power for up to 36 hours
- Small size, easy to relocate
- Simple to operate under stressful emergency conditions
- Skid mounted for portability
- Modular design in 2 sizes can be combined for any sized refuge station needs
- Ten year underground life expectancy

DESCRIPTION

Experience dictates that accidents, mine fires or the sudden release of toxic or other gases can occur at any time and without warning. In a closed or sealed refuge station, CO₂ levels can rise and O₂ levels can deplete quickly to dangerous levels, putting lives at risk. Conventional sources of respirable air such as compressed high pressure cylinders or piped air from the surface can be dangerous or compromised in an emergency. Prepare for the unexpected with the **REFUGE ONE AIR CENTRE**. The **REFUGE ONE** has been designed as a source of respirable air during an emergency, providing safe, breathable air in a compact, moveable unit. Even if electrical power is cut off, the unit will operate for at least 36 hours on it's own battery supply. It constantly removes potentially harmful levels of Carbon Dioxide and replenishes Oxygen, maintaining safe breathing air within a sealed refuge station for up to 36 hours*.

*Actual capacity will depend on number of people in the refuge station. See minimum performance characteristics on opposite page.



Awarded the 1995 R&D
award for Significant
Technology

RANA-Medical

PATIENT FIRST
RESPIRATORY SERVICES

www.ranamedical.com

SPECIFICATIONS

Physical Dimensions:

Single Bed Unit:

Length: 57.25"
Width: 29.5"
Depth: 25.5" (15" with cover removed)
Weight: 720 lbs (500 lbs w/o O₂ cylinders)

Double Bed Unit:

Length: 55.5"
Width: 31"
Depth: 65.5"
Weight: 1,545 lbs (1,155 w/o O₂ cylinders)

Electrical:

115V, 60Hz standard (Other voltages/frequencies available)

Oxygen connectors:

CGA540 standard, other connections available

Mechanical:

Skid mounted for easy forklift transport.

MINIMUM PERFORMANCE CHARACTERISTICS

Single Bed Unit: (with 15 people)
Oxygen: 30 hours
Carbon Dioxide Absorption: 31 hours
Battery Capacity: 36 hours

Double Bed Unit: (with 30 people)
Oxygen: 20 hours
Carbon Dioxide Absorption: 31 hours
Battery Capacity: 36 hours

Note: This data sheet contains only a general description of the REFUGE ONE AIR CENTRE. While uses and performance capabilities are described, under no circumstances should the product be used except by qualified, trained personnel, and not until the instructions, labels and other literature accompanying them have been carefully read and understood. All safety precautions must be followed. In accordance with RANA-Medical's policy of continued development, specifications subject to change without notice.

OPERATING INSTRUCTIONS

The REFUGE ONE AIR CENTRE has been designed to operate under stressful conditions. The startup instructions are simple and easy to follow:

- 1) Break the security seals and remove the cover
- 2) Install the carbon dioxide absorbent chemical
- 3) Start the blower
- 4) Turn on the oxygen cylinders
- 5) Set the oxygen flow rate according to the number of people occupying the Refuge Station.

AIR/OXYGEN FLOW DIAGRAM

Refuge Station Air

CO₂ Elevated
O₂ Depleted

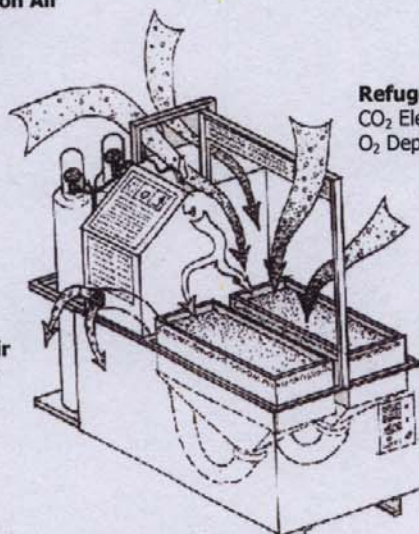

Refuge Station Air

CO₂ Elevated
O₂ Depleted

Processed Air

CO₂ Removed
O₂ Added

TEST REPORT & MORE INFORMATION

The REFUGE ONE AIR CENTRE has been tested under realistic conditions. To obtain more information or the results of the CANMET Mining Research Laboratory test report, please contact us at the address below.

More information, including a comprehensive guide to providing respirable air in a refuge station entitled "Respirable Air Handbook" is available on our website or at the address below.

For More Information, Please Contact:

RANA-Medical

PATIENT FIRST
RESPIRATORY SERVICES

205 Stephen Street
Morden, Manitoba, Canada
R6M 1V2
Phone: (204) 822-6595
Fax: (204)-822-3852

Distributed By:

RANA-Medical

RESPIRATORY WELLNESS CENTRE



:: [Home](#) :: [Our Mission](#) :: [Products](#) :: [Respiratory Services](#) :: [Sleep Services](#) :: [Hospital Equipment](#) :: [Mine Refuge](#) ::
 :: [Contact Us](#) :: [Privacy Policy](#) :: [Links](#)

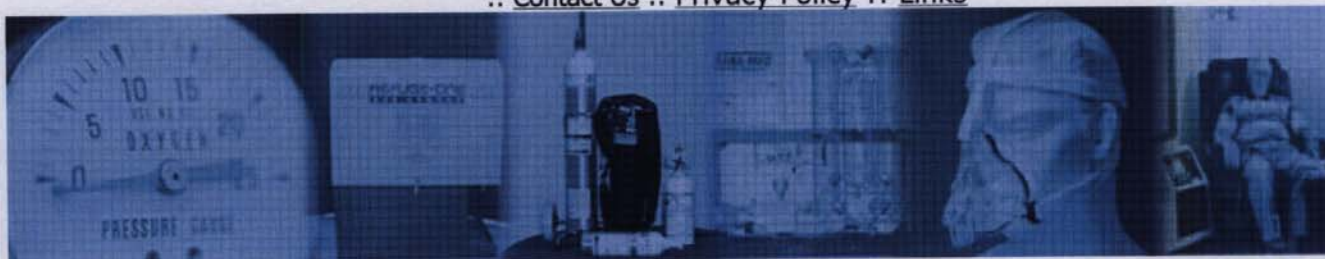

[Home](#) > [Our Mission](#)

Respironics Inc. has recently established RANA-Medical as a Canadian Factory Authorized Service (FAS) for oxygen concentrators and sleep therapy equipment. For more details, [click here](#).

Rimer Alco North America (RANA)-Medical is a diversified company founded in 1987, providing products and services to the hospital, mining, and homecare respiratory community. We are the leading provider of hospital oxygen concentrator systems in North America, with over 60 facilities throughout Canada and the Caribbean relying on RANA-MED equipment to produce on-site medical oxygen.

Refuge One Air Centres are in use around the world to provide a safer working environment in mines, and were the recipient of the prestigious R & D Magazine's 100 Best Inventions award.

We are also a leading provider of home respiratory and sleep testing services, with offices throughout Manitoba and Calgary. We specialize in home oxygen therapy, asthma and C.O.P.D. education and supplies. We carry a wide range of products from the leading manufacturers and offer superior customer service, including:

- Free home delivery throughout Manitoba
- Quality products from the top manufacturers, at competitive, fair prices
- Friendly staff that is well-trained, honest, hard-working, and caring
- 24 hour a day, 7 day a week emergency support and service

We look forward to hearing from you -- please contact us for more information about our many products and services.

Calgary

RANA-Medical -- Respiratory Wellness Centre
 Provident Professional Building
 #109-4616 Valiant Drive NW
 Calgary, AB T3A 0X9

Morden

RANA-Medical
 205 Stephen Street
 Morden, MB R6M 1V2

Phone: (204) 822-6595

Fax: (204) 822-3852

Winnipeg

Brandon

RANA-Medical -- Respiratory Wellness Centre
72 Scurfield Boulevard
Winnipeg, MB R3Y 1G4

RANA-Medical
Unit 1-559 8th Street
Brandon, MB R7A 3X8

RANA-Medical also operates under the following brand:



Hospital oxygen equipment, including oxygen concentrators, medical air and vacuum systems, oxygen distribution systems and hospital pipeline maintenance and testing services



205 Stephen Street
Morden, MB R6M 1V2
(204) 822-6595
rana@ranamedical.com

Copyright © 2004-2006 Rimer Alco North America. All Rights Reserved.

:: [Site Map](#) ::



SHAIRZAL

SAFETY ENGINEERING

YOUR LOCAL SAFETY EQUIPMENT COMPANY

STAND ALONE CARBON DIOXIDE SCRUBBING SYSTEM



THIS STAND ALONE SYSTEM ONLY REQUIRES PLACING INTO POSITION AND TWO G SIZE OXYGEN CYLINDERS.

Shairzal forms the largest partnership in mine safety and purpose built equipment. Our service network is Australia wide—see overleaf.



BATTERY CHARGER

PLACED ABOVE GROUND LEVEL FOR CHARGING TWO BATTERIES AT THE SAME TIME.

VISIT our web site WWW.SHAIRZAL.com.au



HEAD OFFICE – 28 Jersey Rd, Bayswater, VIC 3153 PO Box 982, Bayswater, VIC AUSTRALIA 3153

Ph: +613 9720 3877

Fax: +613 9720 3529



SHAIRZAL
SAFETY ENGINEERING

YOUR LOCAL SAFETY EQUIPMENT COMPANY

CARBON DIOXIDE SCRUBBER

**CONVERT YOUR
REFUGE OR CRIB
ROOM QUICKLY &
EASILY WITH THIS
(48 HOUR) FULLY
STAND ALONE FIT IN.**

The Refresh 48 is a self contained system that is designed to provide oxygen at controlled rates and to remove carbon dioxide (CO₂) from air in an enclosed or confined space. The system is powered by 240 Volt and has an inbuilt battery backup. It can run for a 48 hour period without mains power connected.

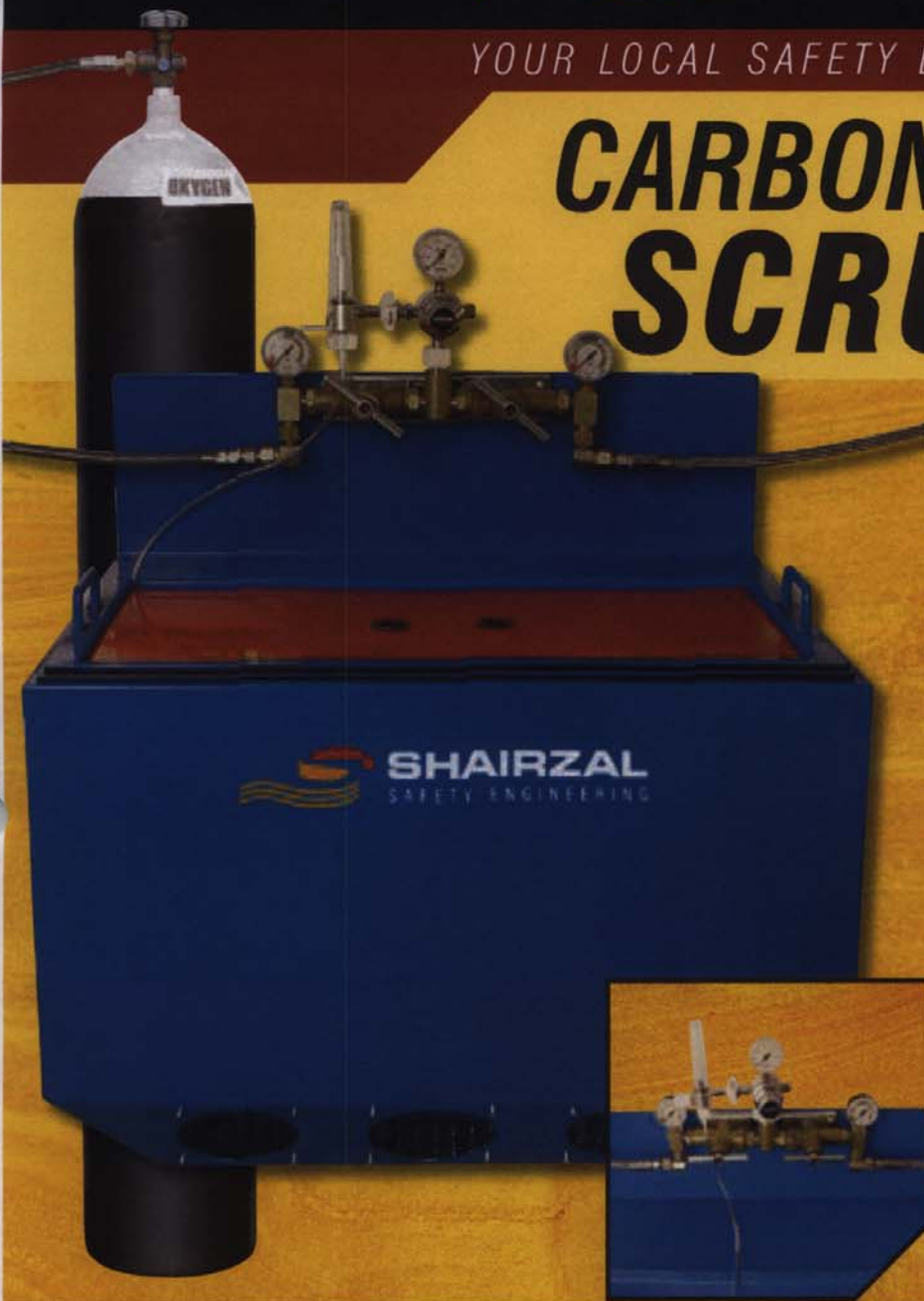

VISIT our web site WWW.SHAIRZAL.com.au

Shairzal forms the largest partnership in mine safety and purpose built equipment. Our service network is Australia wide—see below.



HEAD OFFICE – 28 Jersey Rd, Bayswater, VIC 3153 PO Box 982, Bayswater, VIC AUSTRALIA 3153

Ph: +613 9720 3877

Fax: +613 9720 3529

TOWNSVILLE SKINDIVING CENTRE - QLD

67A Railway Av, Railway Estate, Townsville, QLD 4810
Ph: (07) 4771 5997 Fax: (07) 4771 5701



EMERGENCY MANAGEMENT SOLUTIONS - TAS

424 Hobart Rd, Youngtown, TAS 7249
Mob: 0409 367 000 Fax: (03) 6343 0347

EMS

AMES (Australian Mining Evacuation Systems) - NSW

8 Lyndon Ave, Bellbridge
Ph/Fax: 02 6026 4398

AMES

KALGOORLIE MINING & SAFETY - WA

72 Brookman St, Kalgoorlie, WA 6430
Ph: (08) 9022 5100 Fax: (08) 9021 7083



KALGOORLIE MINING & SAFETY - WA

Unit 2 / 321 Victoria Road, Malaga, WA 6945
Ph: (08) 9209 6300 Fax: (08) 9248 2977



STRATA PRODUCTS USA

REQUEST INFO

HOME

LIST OF PRODUCTS
AND SERVICES
AVAILABLE IN:

UNITED STATES

EUROPE

AUSTRALIA

SOUTH AFRICA

STRATA
MINE SERVICES

NEWS & ARTICLES

CARBON DIOXIDE
SCRUBBER

- Self contained system designed to provide oxygen at controlled rates and remove carbon dioxide from the air in enclosed areas
- It utilizes H-size oxygen cylinders and soda lime chemicals
- An Oxygen Flow Meter regulates the amount of oxygen released and this is according to the number of people in the station. Clear instructions are printed in front of the unit
- To operate, the user fills the top tray with soda lime chemicals, turns the system using a simple on/off switch and opens the valves on the oxygen cylinders
- The system is electrically powered and has a 36 hour built in battery back up power is lost
- An LCD display provides instant inspection of the systems charge condition
- The system removes bacteria, mold, odors and Volatile Organic Compounds
- This is a stand alone system which is used in the Shairzal® Emergency Refu as a back-up air supply system

Clearly printed operational
instructions

Soda Lime tray hold chemicals



during use



Oxygen Flow meter regulates the amount of oxygen released into the station. Settings depend on the number of occupants.

SPECIFICATIONS

- Constructed out of welded, powder coated steel
- Size - 36" wide x 16" deep x 39" high
- Weight - 154 lbs
- Two H-size cylinders for 10 men and four for 15 to 20 men provide 24 of oxygen
- .55 lbs of chemicals, per person, per hour (soda lime available in 44 lb kegs)

POWERLESS CO₂ SCRUBBER

Patented CO₂ scrubbing system that requires no electrical power to run. Utilizes only compress air cylinders and soda lime chemicals to successfully scrub the CO₂ out of the air.



Powerless CO₂ Scrubber

[Download Adobe pdf file of the CO₂ Scrubber System product sheet.](#)

[Strata Products USA Home](#) | [Strata Mine Services](#) | [Request More Information](#) | [News & Article](#)
[Fresh Air Bay](#) | [Emergency Refuge Station](#) | [Scrubber System](#) | [AIRDOC](#) | [Propsetter Yieldable System](#) | [Sand Prop](#) | [Bolt Prop](#) | [Cluster Prop](#) | [Rocprop](#) | [Duke Prop](#) |

STRATA PRODUCTS USA

REQUEST INFO

HOME

**LIST OF PRODUCTS
AND SERVICES
AVAILABLE IN:**

UNITED STATES

EUROPE

AUSTRALIA

SOUTH AFRICA

STRATA
MINE SERVICES

NEWS & ARTICLES

ExtendAir® CO₂ Absorbent Curtain

- The ExtendAir® Lithium Hydroxide curtain is a passive CO₂ absorbent
- When hung with all sides exposed, it effectively absorbs the CO₂ out of the air in enclosed areas
- It is approved and used by the US Navy for emergency atmospheric control on submarines
- It offers rapid CO₂ reduction to acceptable and safe levels
- Requires no electrical power
- It is especially developed for handling in emergencies
- No protective mask needed during deployment
- They have higher packaging density and more efficient absorption as comp systems
- Through Strata Products, they are intended for use with the Portable Fresh underground refuge rooms, in conjunction with Life Gas® oxygen bottles



KEY FEATURES AND BENEFITS

- Fast and easy deployment with not tools or electrical power required
- Begin working immediately
- Tested performance
- Currently used by the US Navy
- Packaged in US Mil-B-131H soft foil inner pouches and rigid ammo bc



Soft Foil Pouches



Rigid ammo box
8 Curtains per box

TESTING

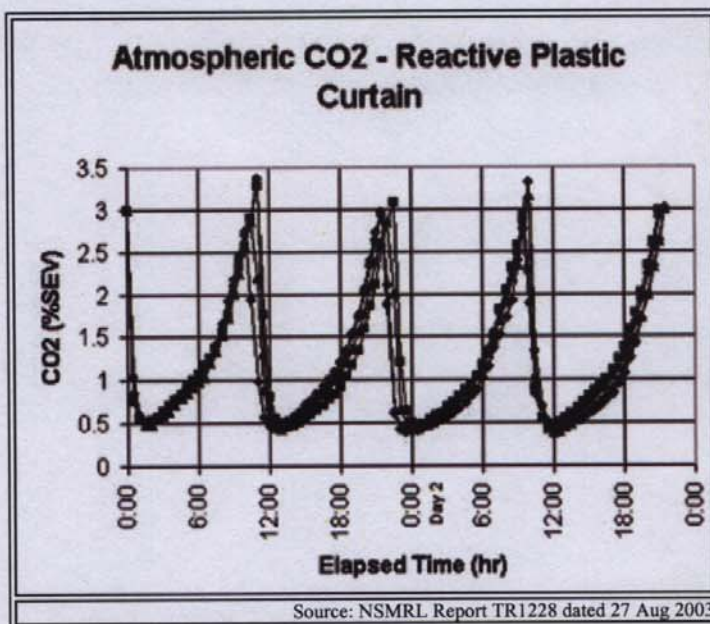

*3% is the standard maximum level of CO2 in breathing air. Each peak in the graph represents the additional set of curtains was added to the ones already in place. At these points the level of CO2 d

DEPLOYMENT SCHEDULE FOR THE PORTABLE FRESH AIR

Time Duration in sealed shelter (hrs)	Number of Curtains to deploy time		
	5-Man	10-Man	12-Man
0-(Initial entry into sealed shelter)	16	24	24
+12	+8	+16	+18
+24	+8	+16	+24
+36	+8	+16	+18
+48 (remove first set hung)	+8	+16	+24
+60 (remove second set hung)	+8	+16	+18

+72 (remove third set hung)	+8	+16	+24
+84 (remove forth set hung)	+8	+16	+18
Total Boxes of 8 curtains deployed	9	17	21
Note: ₁ Curtains can be removed after 48 hrs exposure			
₂ At each deployment ADD new curtains to ones already hanging			

SPECIFICATIONS

Configurations -->	5-man kit	10-man kit	12-man kit
Number of boxes needed for 4-day supply	9	17	21
Kit Net Weight absorbent (lbs)	54	102	126
Kit Gross Weight (lbs)	117	221	273
Kit storage volume (ft ³)	3.94	7.44	9.2
Kit storage volume (m ³)	.11	.21	.26

Download Adobe pdf file of the ExtendAir[®] Curtains product sheet.

Please read about the [Fresh Air Bay](#)

[Strata Products USA Home](#) | [Strata Mine Services](#) | [Request MoreInformation](#) | [News](#)
[Fresh Air Bay](#) | [Emergency Refuge Station](#) | [Scrubber System](#) | [AIRDOC](#) | [ExtendAir[®] Curtains](#) |
[Support System](#) | [Sand Prop](#) | [Bolt Prop](#) | [Cluster Prop](#) | [Rocprop](#) | [Duke Prop](#)
[Lock-N-Load](#) | [Hercules Mats](#) | [Link-N-Lock](#) | [Thin Support Liners](#) | [Castonite](#)
[Tunnel Guard](#) | [Rocsil Foam](#) | [Marithan](#) | [Hand Grout Pumps](#) | [Pre-Stressing Bags](#) | [Power Wedge](#) |
[Seals: Pre-Loaded](#) | [Concrete and Grout Pumping Services](#) | [Underground Installation](#)

PERSONS CONTACTED AS PART OF MINE REFUGE REPORT
15 NOVEMBER 2006

Country	Organization	Person Contacted	Title	Contact Method	Responded
Australia	Cowan Manufacturing	Tim Owen	Principal Engineer Manager, MineARC Systems America, LLC	Email	Yes
	MineARC Systems	James Rau	Manager, Mines Rescue Service	Email	Yes
	Mines Rescue Pty, Limited	Seamus Devlin	Managing Director	Email	No
	Shairzal Safety Engineering Brazilian Government	Tony Farrugia Unknown	General Inquiry provided on their web page.	Email/in person	Yes No
Canada	RANA Medical Hillsborough Resources Limited	Lyall Gardiner Unknown	Project Manager General Inquiry provided on their web page.	Email Email	Yes No
	European Network of Mining Regions CEMarking	Ken Swanson Unknown	Listed contact person General Inquiry provided on their web page.	Email Email	Yes No
Finland	Safety Technology Authority of Finland (TUKES)	Toivainen Willy	Chief Information Officer	Email	No
	Safety Technology Authority of Finland (TUKES)	Anne-Mari Lahde	Chief Engineer, Process Safety Information Officer	Email	Yes
	Safety Technology Authority of Finland (TUKES)	Vänskä Tarja	Information Specialist	Email	No
	Safety Technology Authority of Finland (TUKES)	Viikari Riitta	Information Officer	Email	No
	Safety Technology Authority of Finland (TUKES)	Kuusio Paula	Information Officer	Email	No

PERSONS CONTACTED AS PART OF MINE REFUGEE REPORT
15 NOVEMBER 2006

Country	Organization	Person Contacted	Title	Contact Method	Responded
Hungary	Hungarian Delegate, EU Parliament	Peter Olajos	Hungarian Delegate, EU Parliament	Email	No
	Hungarian Geological Survey	Tamás Hamor	Head Division of Regulatory and International Affairs	Email	Yes
	Hungarian Mining Bureau	Peter Eszto	President	Email	No
	Hungarian Office For Mining	Forwarded by Dr. Hamor	Unknown	Email	No
Kosovo	Environmental Protection Division	Nezakete Hakaj	Head of Environmental Protection Division	Email	Yes
New Zealand	Huntly East Coal Mine	Paul Hunt	Manager	Email	No
Poland	Central Mines Rescue Station	Zygmunt Goldstein	Mine Management	Email	No
	Department of Mining	Wojciech Magjera	Director, Mining Department, State Mining Authority	Email	Yes
Romania	National Institute for Safety in Mines and Explosion Protection (INSEMEX)	Emilian Ghicioi	Scientific Director	Email	Yes
	National Hard Coal Company	Unknown	General Inquiry provided on their web page.	Email	No
	National Hard Coal Company	Gheorghe Chiril	Production Chief Engineer	Email	Yes
South Africa	National Hard Coal Company	Sorin Holinger	Head of Mining Safety Control Department	Email	No
	Department of Minerals and Energy	Rickus vanRensburg	Web Contact	Email	No

**PERSONS CONTACTED AS PART OF MINE REFUGEE REPORT
15 NOVEMBER 2006**

Country	Organization	Person Contacted	Title	Contact Method	Responded
South Africa	Department of Minerals and Energy	Unknown	General Inquiry Contact for Mine Safety	Email	No
United States	United States Mine Rescue Association (USMRA)	Rob McGee	Web Contact	Email	Yes
	ChemBio Shelter	Ed Roscioli	Unknown	Telephone/email	Yes
	Draeger	TJ Pitzer	Unknown	Telephone	Yes
	Gamma Services International, Inc.	Tommy McCormick	President	Email	No
	Gamma Services International, Inc.	Dwayne Towery	Vice President of Sales	Email	Yes
	Strata Products	Rory Paton-Ash	President	Email/telephone/in person	Yes
	Jack Kennedy Metal Products & Buildings, Inc.	Bill Kennedy	Unknown	Email	Yes
	Mine SafeHouse, LLC	Erwin Conrad	Unknown	Email	No
	Modern Mine Safety Supply, LLC	Lynn Sitterud	Unknown	Telephone	Yes
	Phoenix First Response	Ian Houlison	Unknown	Telephone	Yes
	Newmont Mining Corporation	Unknown	General Inquiry provided on their web page.	Email	Yes
	Survivair	Steve Weinstein	Product Manager	Telephone	Yes